

Low Voltage Industrial Fuse Links

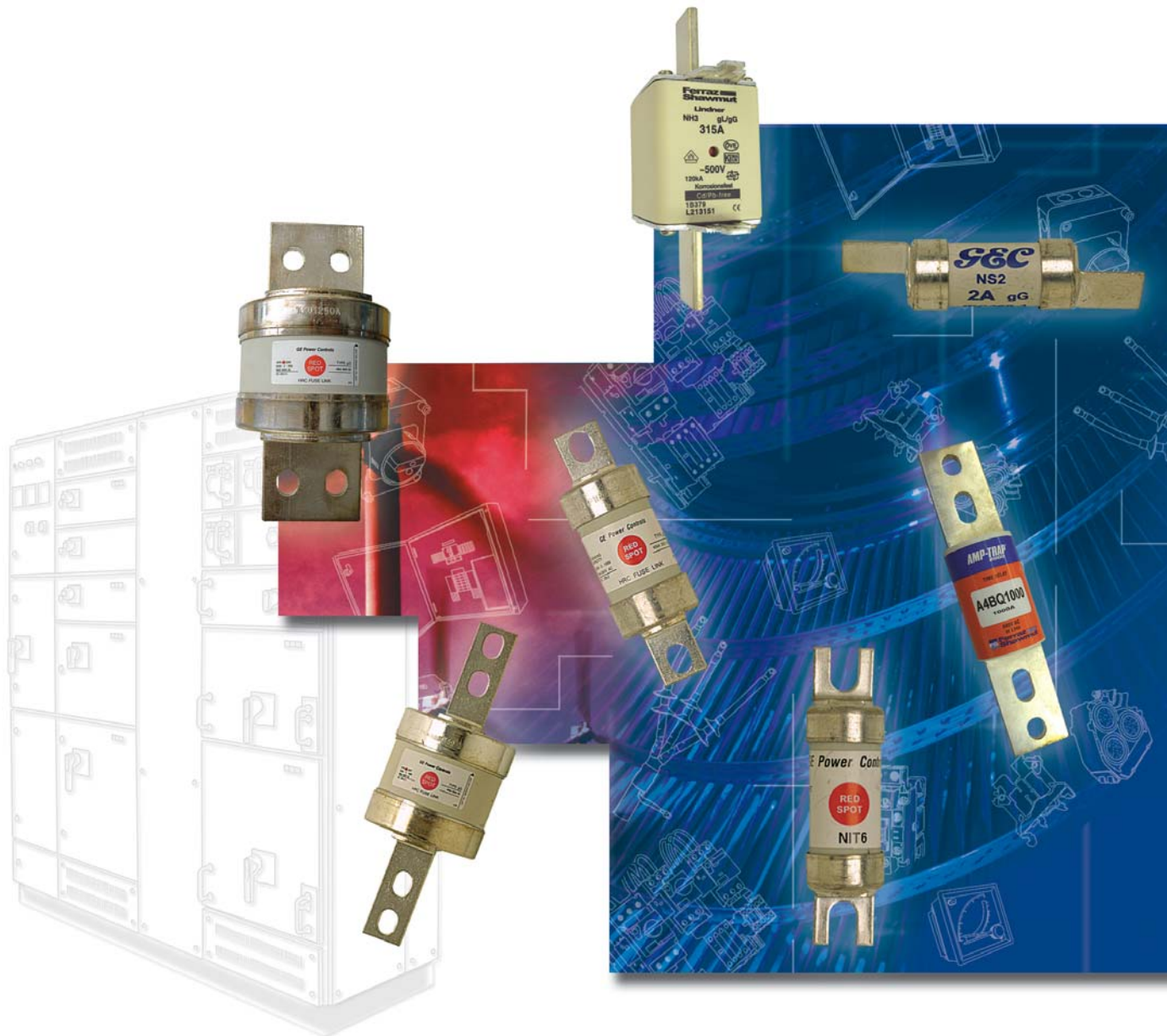

- Bolt-in BS88 T-type fuses
- Clip-in BS88 fuses
- J - Type fuses
- DIN type NH fuses
- Class L power fuses



IPD Industrial Products is an Australian owned distributor of a wide variety of low voltage electrical and automation products for the Australian Industry.

IPD Industrial Products traces its beginnings to the General Electric Company Ltd of England, founded in 1889. Over the years, the company integrated the major electrical businesses of GEC, English Electric, Marconi, Henley and A.E.I to comprise one of the most extensive and diverse electrical engineering and manufacturing organisations in the world.

In 1956, English Electric opened its operation at Regents Park in Sydney, and has provided employment and training to thousands of people in the Australian electrical industry. Today it remains as a much changed and diverse organisation, IPD Industrial Products, a 100% Australian owned, managed and operated company.

IPD Industrial Products delivers strong brand names and leading-edge developments, providing world class manufacturers a powerful presence in Australia. IPD Industrial Products is committed to offering the customer a technically compliant solutions based offering.

IPD Industrial Products designs and manufactures a large range of products specifically suited to the local environment. An in-house engineering team is employed to develop and test equipment, ensuring conformity to Australian Standards and the highest customer satisfaction.

**Visit us at:
www.ipdgroup.com.au**

»»»» IPD Distributes the following brands:





British Standard Fuse-links, Bolt-in type "T"

- General Purpose full range protection – Class gG and gM
- Two voltage ranges 415 and 660V AC
- Complies to BS88 Parts 1, 2, IEC 269 Parts 1 & 2, and AS 3269 Part 1 & 2
- Current ratings from 2A up to 1250A

Page 5



Clip-in BS88 Fuse-links,

- General Purpose full range protection – Class gG and gM
- Complies to BS88 Part 6 and IEC 269
- Current ratings from 2A up to M80

Page 18



Utility Fuse-links, Bolt-in type "J"

- Fuse-link for the protection of over-head line networks and LV distribution feeder pillars.
- General purpose full range protection – Class gU
- Complies to BS88 Part 5 and IEC 269
- Current ratings from 20A up to 800A

Page 20



DIN type NH fuse-links

- General Purpose fuse-links full range protection
- Conforms to IEC 269 and AS 3269
- Utilisation Category, gG @ 500V AC
- Current ratings from 6A up to 1250A
- Also available in 690V AC

Page 22



Power Fuse-links Class "L"

- General Purpose fuse-links full range protection – Class "L"
- Conforms to UL and CSA
- Current ratings from 100A up to 6,000A

Page 25

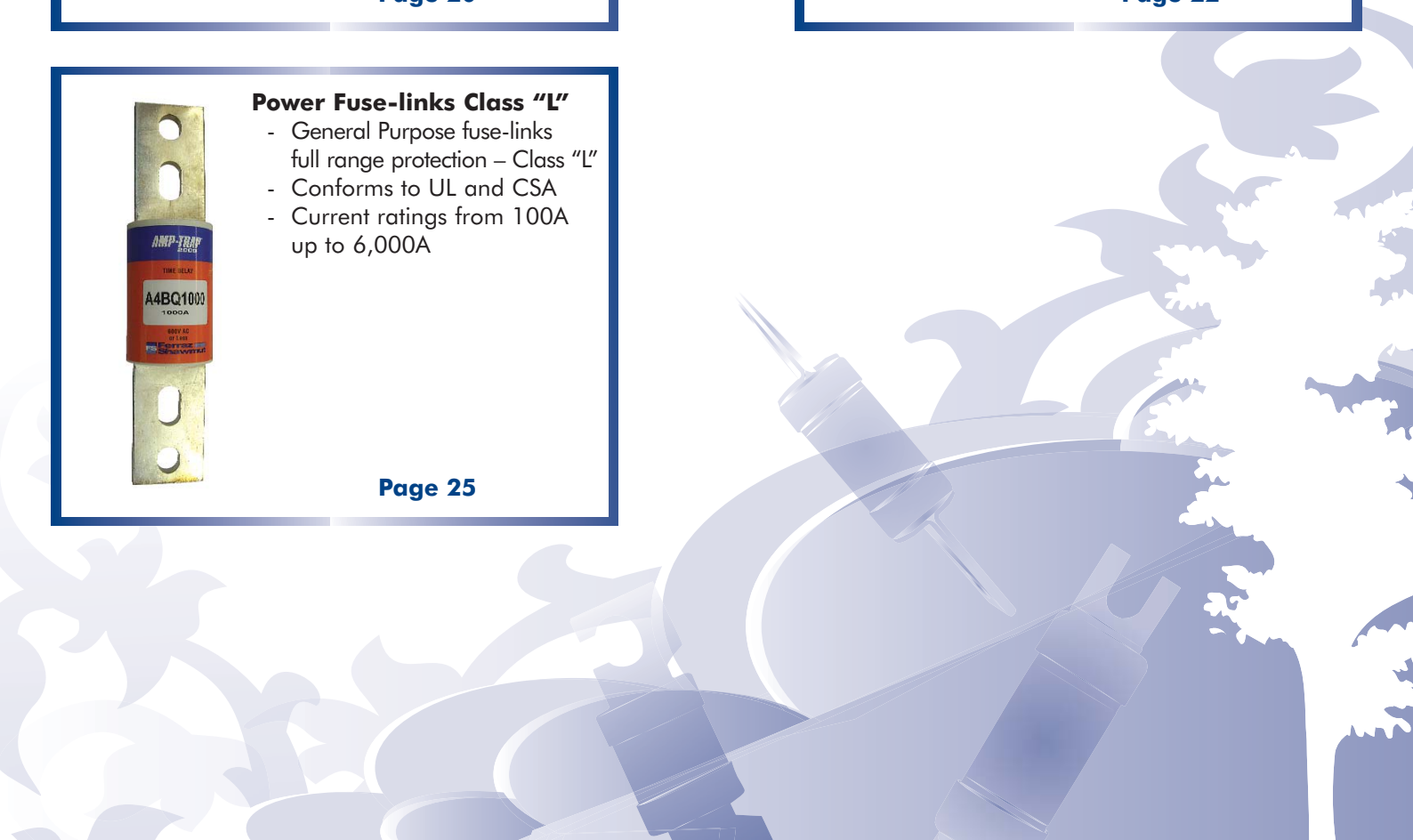

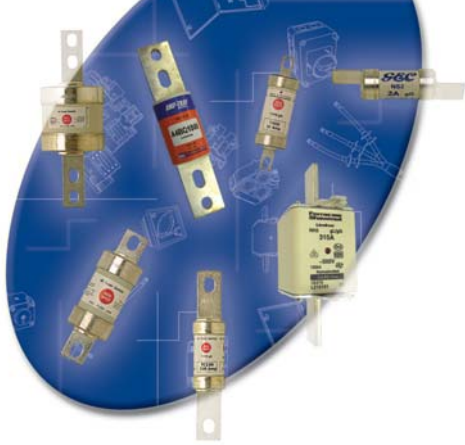

INTRODUCTION - BS88 TYPE T FUSE LINKS

The contents of BS88:Part 2:1988 (and the associated IEC269-2 and AS2005.21.2) were taken into consideration by the designers when the complete range of type 'T' fuse links were re-designed some time ago.

There are therefore no changes in the electrical characteristics of the fuse links detailed in this publication an important point to note for those users who have approved equipment or engineered installations based on their use.

Type 'T' fuse links meet all the requirements of BS88: Part 2:1988 and this publication details changes in terminology and practice resulting from the issue of that standard.

All references made refer to GEC and GE Red Spot fuse links.

AC Performance

ASTA 20 certified at 80kA from 415V to 660V, to BS88: Part 2:1988.

DC Performance

Up to 460V to BS88:Part 2:1988.

Protection of PVC insulated Cables

Class 'gG' ratings provide complete protection, and enable cables to be fully rated.

Discrimination

Type 'T' fuse links will discriminate with each other at fault levels up to 80kA, 415V when the ratio between 'major' and 'minor' current ratings is 1.6:1.

Motor Starting Ability

All type 'T' fuse links are suitable for use in motor circuits and have superior motor starting ability.

The availability of class 'gM' fuse links enhances this capability.

Motor Circuit Protection

Type 'T' fuse links combined with the contactors and relays of leading manufacturers, provide effective short circuit protection.

Energy Conservation

All type 'T' fuse links have low power loss values, well within the limits specified in BS88:Part 2:1988.



Approvals

Approved by leading authorities, including Lloyds, CEBG, and Ministry of Defence, as being made to recognise standards of quality assurance (including BS5750:Part 1:1987 and AS3902-1987).

PERFORMANCE DATA

Type	Ratings Amp	Utilisation Category	BS88-2 Dimension Reference	Maximum Voltage Rating AC	DC
415V Range					
NIT...L	2 - 32	gG	A1	415	240
NIT...L	20M25, 20M32	gM	A1	415	240
TIA...L	2 - 32	gG	A2	415	240
TIA...L	32M35 - 32M63	gM	A2	415	240
TIS...L	35 - 100	gG	A3	415	240
TCP...L	63 - 100	gG	A4	415	240
TCP...L	100M125 - 100M200	gM	A4	415	240
TFP...L	125 - 200	gG	-	415	240
TFP...L	200M250 - 200M315	gM	-	415	240
TC...L	80, 100	gG	B1	415	240
TF...L	125 - 200	gG	B1	415	240
TF...L	200M250 - 200M315	gM	B2	415	240
TKF...L	250, 315	gG	B3	415	240
TKF...L	315M400	gM	B3	415	240
TKM...L	250, 315	gG	-	415	240
TMF...L	355, 400	gG	B4	415	240
TM...L	355, 400	gG	C1	415	240
TTM...L	450 - 630	gG	C2	415	240
TLM...L	670 - 800	gG	C3	415	240
660V Range					
NIT	2-20	gG	A1	550	250
NIT	25, 32	gG	A1	440	250
NIT	20M25, 20M32	gM	A1	440	-
TIA	2-32	gG	A2	660	460
TIA	32M35 - 32M63	gM	A2	660	460
TIS	35-63	gG	A3	660	460
TIS	63M80, 63M100	gM	A3	660	-
TCP	80, 100	gG	A4	660	350
TCP	100M125 - 100M200	gM	A4	660	350
TFP	125-200	gG	-	660	350
TB	2-63	gG	-	660	460
TBC	2-63	gG	-	660	460
TC	80, 100	gG	B1	660	350
TF	125-200	gG	B2	660	350
TF	200M250	gM	B2	660	460
TF	200M315	gM	B2	550	-
TKF	250, 315	gG	B3	660	460
TKF	315M355	gM	B3	660	460
TKM	250, 315	gG	-	660	460
TMF	355, 400	gG	B4	660	460
TMF	400M450	gM	B4	660	460
TM	355, 400	gG	C1	660	460
TM	400M450	gM	C1	660	460
TMT	355-400	gG	-	660	460
TTM	450-630	gG	C2	660	450
TTM	630M670	gM	C2	660	450
TT	450-630	gG	-	660	450
TLM	670-800	gG	C3	660	350
TLT	670-800	gG	-	660	350
TLU	560-800	gG	-	660	350
TXU	1000, 1250	gG	D1	660	300

Notes: 'ASTA20 Certified' endorsement on a low voltage fuse link indicates that the design has been proved and Certified by ASTA to the relevant British Standard and that the fuse links are examined periodically under the ASTA surveillance scheme.

LIST NUMBERS & DIMENSIONS

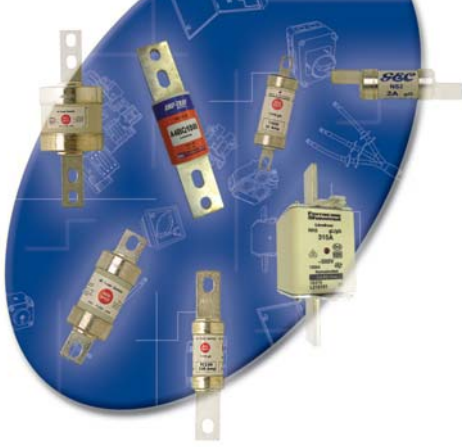

Off-set Tags 2-hole Fixing



Type	Rating Amp	List Numbers	Dimensions in mm								
			A	B	D	E	F	G*	H	K	
NIT 2-32A	2	NIT2 L	36.50	13.90	55.00	10.90	0.80	44.50*	4.70	14.30	
	4	NIT4 L	BS88: 1988 Dimensional Ref. A1						*Fixing Centres		
	6	NIT6 L									
	10	NIT10 L									
	16	NIT16 L									
	20	NIT20 L									
	25	NIT25 L									
	32	NIT32 L									
	20M25	NIT20M25 L									
	20M32	NIT20M32 L									

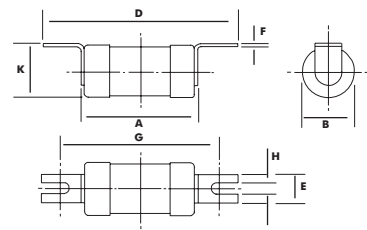

Off-set Tags 2-hole Fixing



Type	Rating Amp	List Numbers	Dimensions in mm									
			A	B	D	E	F	G*	H	J	K	
TIA 2-32A	2	TIA2L	55.00	23.00	84.00	8.70	1.20	73.00*	5.20	7.10	23.80	
	4	TIA4L	BS88: 1988 Dimensional Ref. A2						*Fixing Centres			
	6	TIA6L										
	10	TIA10L										
	16	TIA16L										
	20	TIA20L										
	25	TIA25L										
	32	TIA32L										
	32M35	TIA32M35L										
	32M40	TIA32M40L										
	32M50	TIA32M50L										
	32M63	TIA32M63L										
	TIS 35 - 100A	35	TIS35L	55.00	23.00	84.00	8.70	1.20	73.00*	5.20	7.10	23.80
40		TIS40L										
50		TIS50L	BS88: 1088 Dimensional Ref. A3						* Fixing Centres			
63		TIS63L										
80		TIS80L										
100		TIS100L										
63M80		TIS63M80L	58.00	26.20	90.50	12.70	1.20	73.00*	5.20	-	27.80	
63M100		TIS63M100L										
TCP 63 - 100A	80	TCP80	58.00	26.20	111.00	19.10	2.40	93.70*	8.70	11.90	27.50	
	100	TCP100										
	63	TCP63L	67.00	36.10	111.00	19.50	3.20	94.00*	11.00	8.70	38.50	
	80	TCP80L	69.50	34.50	111.00	19.10	2.40	93.70*	8.70	11.90	34.90	
	100	TCP100L										
	100M125	TCP100M125							* Fixing Centres			
	100M160	TCP100M160										
	100M200	TCP100M200										
	100M125	TCP100M125L	67.00	36.10	111.00	19.50	3.20	94.00*	11.00	8.70	38.50	
	100M160	TCP100M160L										
100M200	TCP100M200L											
TFP 125 - 200	125	TFP125	70.00	34.50	111.00	19.10	2.40	93.70*	8.70	11.90	34.90	
	160	TFP160	BS88: 1088 Dimensional Ref. A4						* Fixing Centres			
	200	TFP200										
	125	TFP125L	67.00	36.10	111.00	19.50	3.20	94.00*	11.00	8.70	38.50	
	160	TFP160L										
	200	TFP200L										
	200M250	TFP200M150L	76.00	41.90	111.00	19.50	3.20	94.00*	11.00	8.70	44.00	
	200M315	TFP200M315L										

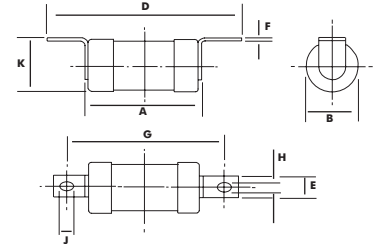

LIST NUMBERS AND DIMENSIONS

Central Tags 2-hole Fixing



Type	Rating Amp	List Numbers	Dimensions in mm								
			A	B	D	E	F	G*	H	J	M
TB 2-63A	2	TB2	58.00	26.20	111.90	12.70	1.60	96.90*	7.10	10.30	61.90
	4	TB4									
	6	TB6									
	10	TB10									
	16	TB16									
	20	TB20									
	25	TB25									
	32	TB32									
	35	TIB35									
	40	TB40									
	50	TB50									
	63	TB63									
*Fixing Centres											
TBC 2-63A	2	TBC2	58.00	26.20	128.70	14.30	1.60	111.00*	8.70	11.90	61.90
	4	TBC4									
	6	TBC6									
	10	TBC10									
	16	TBC16									
	20	TBC20									
	25	TBC25									
	32	TBC32									
	35	TBC35									
	40	TBC40									
	50	TBC50									
	63	TBC63									
*Fixing Centres											
TC 80 & 100A	80	TC80	58.00	26.20	136.50	19.10	3.25	111.00	8.70	11.90	58.80
	100	TC100									
	80	TC80L	68.50	34.00	136.50	19.10	3.30	111.00*	8.70	11.90	79.40
			BS88: 1988 Dimensional Ref B1 *Fixing Centres								
TF 125 - 200A	125	TF125	70.00	34.90	136.50	19.10	3.20	111.00*	8.70	11.90	79.40
	160	TF160									
	200	TF200									
	125	TF125L	77.00	40.00	136.50	19.10	3.20	111.00*	8.70	11.90	79.40
	160	TF160L	BS88: 1088 Dimensional Ref. B2 *Fixing Centres								
	200	TF200L									
	200M250	TF200M250									
	200M315	TF200M315									
	200M250	TF200M250L	76.00	41.90	111.00	19.50	3.20	94.00	11.00	87.00	76.00
200M315	TF200M315L										
TKF 250 - 315A	250	TKF250L	75.50	54.00	138.00	25.40	3.20	111.00*	8.70	11.90	82.00
	315	TKF315L	BS88: 1088 Dimensional Ref. B2 *Fixing Centres								
	315M355	TKF315M355									
	315M400	TKF314M400L	75.00	59.10	138.00	26.00	4.80	111.00*	8.70	14.00	75.00
TKM 250 - 315A	250	TKM250	77.00	54.00	160.20	25.40	3.20	133.40*	10.30	13.50	82.00
	315	TKM315									
	250	TKM250L	73.00	41.90	159.00	26.00	3.20	133.00*	10.30	14.00	73.00
	315	TKM315L									
TMF 355 - 400A	355	TMF355	83.00	61.10	136.50	25.40	6.30	111.00*	8.70	11.90	85.80
	400	TMF400	BS88: 1088 Dimensional Ref. B4 *Fixing Centres								
	400M450	TMF400M450									
	355	TMF355L	75.00	59.10	138.00	26.00	4.80	111.00*	8.70	14.00	75.00
	400	TMF400L									

Note:

Where dimensions differ between 415V (L type) & 660V types, both types are listed.



LIST NUMBERS AND DIMENSIONS

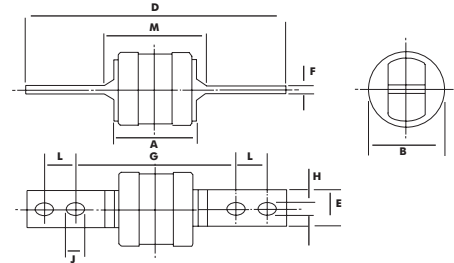

Central Tags 4-hole Fixing

Type	Rating Amp	List Numbers	Dimensions in mm										
			A	B	D	E	F	G*	H	J	L	M	
TM 355 & 400A Extended Motor Range 400M450+	355	TM355L	83.00	61.10	211.0	25.40	6.30	133.00*	10.30	11.90	25.40	95.00	
	400	TM400L	BS88: 1988 Dimensional Ref. C1						*Fixing Centres				
	400M450	TM400M450											
TMT 355 & 400A	355	TMT355	83.00	61.10	255.40	25.40	6.30	165.00*	10.30	13.50	31.80	95.00	
	400	TMT400	*Fixing Centres										
TTM 450-630A	450	TTM450L	81.80	76.20	209.60	25.40	6.30	133.00*	10.30	11.90	25.40	95.00	
	500	TTM500L	BS88: 1988 Dimensional Ref. C2						*Fixing Centres				
	560	TTM560L											
	630	TTM630L											
TT 450-630A	450	TT450	81.80	76.20	266.70	38.10	6.30	165.00*	10.30	15.10	31.80	108.00	
	500	TT500	*Fixing Centres										
	560	TT560											
	630	TT630											
TLM 670-800A	670	TLM670L	88.10	82.50	209.60	25.40	9.50	133.00*	10.30	15.10	25.40	100.10	
	710	TLM710L	BS88: 1988 Dimensional Ref. C3						*Fixing Centres				
	750	TLM750L											
	800	TLM800L											
TLT 670-800A	670	TLT670	88.10	82.50	266.70	38.10	7.80	165.00*	10.30	15.10	31.80	114.30	
	710	TLT710	*Fixing Centres										
	750	TLT750											
	800	TLT800											

Central Tags 4-hole Fixing

Type	Rating Amp	List Numbers	Dimensions in mm										
			A	B	D	E	F	G*	H	J	L	M	
TLU 560-800A	560	TLU560	90.50	83.30	200.00	63.50	9.50	149.00*	13.50	15.90	31.80	101.60	
	630	TLU630	*Fixing Centres										
	670	TLU670											
	710	TLU710											
	750	TLU750											
800	TLU800												
TXU 1000-1250A	1000	TXU1000	88.90	101.60	200.00	63.50	9.50	149.00*	13.50	16.70	31.80	95.00	
	1250	TXU1250	BS88: 1988 Dimensional Ref. D1						*Fixing Centres				

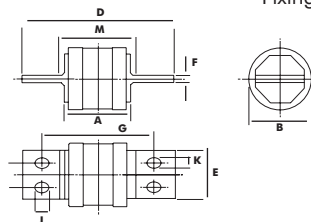

Utilisation Categories 'gG' and 'gM'

Some of the fuse link types used in some European Countries have only partial range breaking capacity (ie, they interrupt short circuit fault currents, but are unable to interrupt overload currents safely). To distinguish these types from the much more widely used general purpose fuse links, the concept of 'utilisation category' has been introduced in the international standard IEC269.

Since AS2005 & BS88 are based upon IEC269, it includes the same utilisation classes, each of which is defined by a two letter code. The first letter indicates the breaking range of the fuse link, as follows:

'g' full range breaking capacity fuse link.

'a' partial range breaking capacity fuse link.

The second letter indicates utilisation category, as follows:

'G' Fuse link for general application, including the protection of motor circuits.

'M' Fuse link for protection of motor circuits.

The standards combine these letters to recognise three classes ie, gG, gM and aM.

All type 'T' fuse links are classified as either gG or gM, and so have a full range breaking capacity.

A class gM fuse link has a dual basis of current rating, the smaller one of which is its continuous rating (I_n), whilst the larger one is its rating with respect to its time/current characteristics (I_{ch}) and is thus an indication of its ability to withstand motor starting surges.

The two ratings are separated by an 'M' in list numbers, eg, 32M63. A class gG fuse link has only one, continuous rating.

BS88:Part 2:1988 specifies a time/current zone for each current rating within which its published time/current characteristics must lie. The time/ current zone for a gM type is defined according to its larger current rating, and thus the characteristics of a 32M63 rating must fall within the same zone as a 63A class gG rating.

Class gM fuse links exist only to enable economies to be achieved in the size of equipment used in motor circuits, eg, 32M63 fuse links can be fitted in 32A fuse holders in a 15kW, 415V, direct on line motor circuit, instead of 63A gG fuse links in 63A fuse holders, because although the motor starting surge required the use of fuse links with 63A time/current characteristics, the motor FLC is less than 32A (about 28A).

It should therefore be noted that gM fuse links complement the standard range of ratings, ie, gG types are also used in many motor circuits, with gM ratings applied only when there is an economic advantage to be gained from their use.



CIRCUIT LOADING

Circuit Loading

The HRC fuse link selected for any circuit should have a continuous current rating not less than the full load current of the circuit.

Complete Cable Protection

A standard rating of type 'T' fuse link (classified as type 'gG' to BS88:Part 1:1988, and marked accordingly) will protect an associated pvc insulated cable against both overload and short circuit if its current rating (I_n) is equal to, or less than the current rating of the cable (I_2). This is in accordance with rule 2.4.2.1. listed in AS3000-1991.

Short Circuit Energy Limitation

Type 'T' fuse links limit the peak current and energy let-through to circuit which experience major short circuit faults. This limitation is so great that equipment manufacturers exploit it to product economic designs which, when used in combination with type 'T' fuse links, can withstand very high fault levels. Such users have to prove their equipment under the worst possible conditions (ie. at maximum breaking capacity, at 110% rated voltage, very low power factor, and with faults initiated at most onerous points on the voltage wave), and they require relevant data from the fuse link manufacturer. For type 'T' fuse links this is given in the form of the cut-off current and I^2t characteristics shown on pages 12 to 17 inclusive.

Protection of Cables against Short Circuit Faults

In some circuits (eg, motor circuits) it is not economical practice to match fuse link and cable ratings to provide complete cable protection in the manner described above, because the circuits produce significant over currents during transient conditions. In such cases the fuse links are chosen to withstand the transient conditions, and provide only short circuit protection to the associated cables and other circuit components, the necessary overload protection then being provided by other means. In a motor circuit, for example the contactor and its overload relays afford overload protection to motor windings and cable and the fuse links are chosen to protect all the circuit components against damage when a short circuit fault occurs (see section on motor circuit protection on page 10). The short circuit protection of cables is covered by Section 5 of AS3008.1-1989 and the table shows how Type T fuse links relate to this rule in protecting pvc insulated copper conductors.

Conductor cross sectional area mm ²	Maximum current carrying capacity of copper conductors		Maximum current rating of Type 'T' fuse link that can be used with this conductor Amp
	'Unenclosed' condition Rating as Column 6 of AS3008. 1-1989 Table 5	'Enclosed' condition Ratings as Column 8 of AS3008. 1-1989 Table 5	
	Amp	Amp	
1	13	11	16
1.5	17	14	20
2.5	23	20	35
4	31	26	50
6	40	34	63
10	56	47	80
16	74	62	125
25	105	87	200
35	120	100	250
50	145	125	355
70	185	155	450
95	220	185	560
120	260	220	710
150	300	250	800
185	345	285	1000
240	405	340	1250

Notes:

- (1) Based on formula $I^2t = K^2S^2$ given in AS3008.1-1989, Clause 5.3 where:
 I = current which causes fuse links to operate in 5 seconds
 t = 5 seconds
 K = constant of 111 for pvc insulated copper conductors of initial temp. 75°C and final temp. 160°C.
 S = cross sectional area of conductor in mm²
- (2) For motor start fuse links, the larger of the dual current rating is applicable, eg, 160A for TCP100M160.
- (3) Fuse links below 16A ignored because conductor cross sectional areas is less than 1mm².

DISCRIMINATION BETWEEN FUSE LINKS

Discrimination Between Fuse Links In service, the short circuit fault conditions encountered are usually less exacting than those produced in proving tests on fuse links and associated equipment. AS2005.10-1988 & BS88 Part 1:1988 states that fuse links experience fault currents which produce pre-arcing times longer than 0.01 second in most cases, and on that basis fuse links complying with the standard are deemed to discriminate with each other when the ratio between the current ratings of 'major' and 'minor' fuse links is 1.6:1 (see Figure 1).

Whilst the AS2005 & BS88 statement is reasonable in relation to 240V applications fault currents in major installations can be much greater.

However, even in the latter cases conditions are less onerous than those encountered in test stations (in particular, the circuits are usually three phase with relatively high power factors).

In practice therefore, the I²t values of type 'T' fuse links are significantly less the ones listed on pages 12-15 and they will discriminate with each other at fault levels up to 80kA, 415V, if the relationship between 'major' and 'minor' ratings is as given in the table. In most cases the discrimination ratio is 1.6:1, or less, and this provides economic benefits in modern installations.

Tests have been taken to prove this level of performance.

The above table also gives details of combinations which will discriminate at 415V, 550V and 660V.

Effect of High Enclosure Temperatures

In accordance with AS2005.10-1988 & BS88:Part1:1988 type 'T' fuse links are suitable for use in ambient air temperatures (Ta) not exceeding 40°C with a mean value measured over 24 hours of not more than 35°C.

When fuse links are fitted in enclosures, it is the temperature within the enclosure (Te)* which determines whether it is necessary to derate fuse links. No derating is needed in following cases:

Figure 1

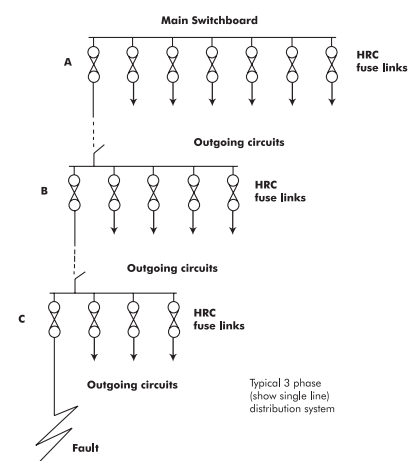

'Minor' fuse link rating	Minimum rating (Amp) of 'Major' fuse link that will discriminate with the 'minor' fuse link at the voltage shown at prospective currents up to 80kA		
	Amp	415v	550v
800	1250	-	-
750	1250	1250	-
710	1250	1250	1250
670	1250	1250	1250
630	1000	1250	1250
560	800	800	1000
500	750	800	1000
450	670	750	800
400	630	670	750
355	630	630	750
315	500	500	630
250	400	450	500
200	315	400	400
160	250	315	315
125	200	200	250
100	160	200	200
80	125	160	160
63	100	160	160
50	80	100	125
40	63	63	100
35	50	63	80
32	40	50	63
25	40	40	40
20	32	32	35
16	25	25	32

Nominal Fuse Rating Amp	Maximum load current at these fluid environment temperatures (Te)*				
	55°	60°	65°	70°	75°
80				75	70
100				95	90
125				120	110
160				145	135
200			190	180	170
250			235	225	210
315		300	285	270	255
355		350	330	315	295
400		400	380	360	340
450		425	405	380	360
500	475	450	425	400	380
560	540	520	495	465	440
630	600	570	540	510	480
670	650	615	585	550	520
710	700	665	630	595	560
750	750	710	670	630	590
800	760	720	680	640	600
1000	950	900	850	800	750
1250	1140	1070	1020	960	900

* Fluid environment temperature (Te) is the temperature inside the enclosure containing the fuse link.



MOTOR CIRCUIT PROTECTION

All type 'T' fuse links have excellent ability to protect motor circuits. When selected in the manner shown below, they not only withstand motor starting surges and full load currents without deteriorating, but also provide superior short circuit protection to associated motor starter components. Leading manufacturers of motor starters can offer ASTA certified type 'c' co-ordination to Appendix C of BS4941:1979 (IEC292-1) and more recently type 2 co-ordination to IEC 947-4-1, by using 660V type 'T' fuse links in combination with their chosen contactors and overload relays.

Please consult IPD Industrial Products for further information on this subject.

Selecting HRC Fuse Links to Protect 3-Phase Motor Circuits

1. Table 1 opposite gives motor full load currents at various voltages. In the absence of specific information obtain the motor FLC from this table.
2. The motors are assumed to produce the starting conditions shown on Table 2.
3. Choose the recommended fuse link for the motor FLC and starting condition from Table 3 (D.O.L. starting) or Table 4 (assisted starting).
4. For certified type C and type 2 co-ordinated motor starters, 550 & 660V fuse links must be specified.

Table 1 Full Load Currents of Typical 3-Phase Induction Motors at Voltages Shown

Motor Rating		220V	380V	415V	440V	550V	660V
kW	HP						
0.37	0.5	2.0	1.15	1.05	1.0	0.8	0.7
0.55	0.75	2.7	1.6	1.5	1.4	1.1	0.9
0.75	1	3.9	2.3	2.0	1.9	1.5	1.3
1.1	1.5	4.7	2.8	2.5	2.4	1.9	1.6
1.5	2	6.5	3.8	3.5	3.3	2.6	2.2
2.2	3	9.3	5.4	5.0	4.7	3.8	3.2
3	4	12	7.1	6.5	6.1	4.9	4.1
4	5.5	15.4	9.0	8.4	7.9	6.4	5.3
5.5	7.5	20.7	11.9	11	10.3	8.2	6.9
7.5	10	28	16.1	14.4	14	11.2	9.3
11	15	39.1	23	21	19.8	15.8	13.2
15	20	52.8	30.5	28	26.4	21.1	17.6
18.5	25	66	38	35	33	26.4	22
22	30	77	45	41	39	31	26
30	40	103	60	55	52	42	35
37	50	128	75	69	65	52	43.3
45	60	151	87	80	75	60	50
55	75	185	107	98	92	74	62
75	100	257	148	136	128	102	85
90	120	308	180	164	154	123	102
110	150	370	214	196	185	148	123
132	175	426	247	226	213	170	142
150	200	500	292	268	252	202	168
160	215	-	300	275	260	207	173
200	270	-	391	358	338	270	225
240	320	-	467	428	404	323	269
280	375	-	533	488	460	368	307
300	400	-	573	525	495	396	330
320	425	-	587	538	507	406	338

Table 2 Assumed Starting Conditions

Motor rating	Direct-on-line starting conditions	Assisted start conditions
Up to 1kW	5xFLC for 5 secs	2.5xFLC for 20 secs
1.1 to 7.5kW	6xFLC for 10 secs	
7.6 to 75kW	7xFLC for 10 secs	3.5xFLC for 20 secs
Greater than 75kW	6xFLC for 15 secs	

MOTOR CIRCUIT PROTECTION

Special motor conditions:

Suitable adjustments to the recommended ratings may be necessary if any of the following conditions occur singly or in combination:

- Starting currents in excess of the assumed ones.
- Long run up times due to high inertia loads.
- Larger number of starts per operating cycle (the recommendations below allow for two starts in rapid succession and up to eight starts per hour).
- High enclosure temperature.

Table 3 Direct-on-line starting

Motor FLC		Recommended fuse link	Alternative motor circuit
Amp		Type 'gG'	rating
FROM	TO	Type 'gM'	
0	0.7	2	
0.8	1.4	4	
1.5	2.0	6	
2.1	3.0	10	
3.1	6.1	16	
6.2	9.0	20	
9.1	11.0	25	20M25+
11.1	14.4	32	20M32+
14.5	15.4	35	32M35
15.5	18.0	40	32M40
18.1	22.0	50	32M50
22.1	28.0	63	32M63
28.1	45	80	63M80
45.1	58	100	63M100
58.1	80	125	100M125
80.1	99	160	100M160
99.1	128	200	100M200
128.1	180	250	200M250
180.1	216	315	200M315*
216.1	270	355	315M355
270.1	328	400	315M400
328.1	385	450	400M450
385.1	430	500	
430.1	500	560	
500.1	560	630	
560.1	620	670	630M670

Table 4 Assisted starting
(Star/delta, auto-transformer, etc.)**

Motor FLC		Recommended fuse link	Alternative motor circuit
Amp		Type 'gG'	rating
FROM	TO	Type 'gM'	
0	1.4	2	
1.5	2.1	4	
2.2	3.1	6	
3.2	5.5	10	
5.6	10	16	
10.1	14	20	
14.1	18	25	20M25
18.1	22	32	
22.1	28	35	32M35
28.1	32	40	32M40
32.1	40	50	
40.1	51	63	
51.1	80	80	
80.1	100	100	
100.1	125	125	
125.1	160	160	
160.1	200	200	
200.1	250	250	
250.1	315	315	
315.1	355	355	
355.1	400	400	
400.1	450	450	
450.1	500	500	
500.1	560	560	
560.1	630	630	

** These recommendations apply for ambient temperatures up to 35°C. At higher ambient temperatures, some fuse links need to be de-rated as indicated on page 9. The decreased rating then becomes the maximum motor FLC at that temperature, eg at 50°C a 630 Amp fuse link is used for motor FLC up to 540 Amps.



CHARACTERISTICS

Type NIT Time/Current Characteristics (including gM ratings)

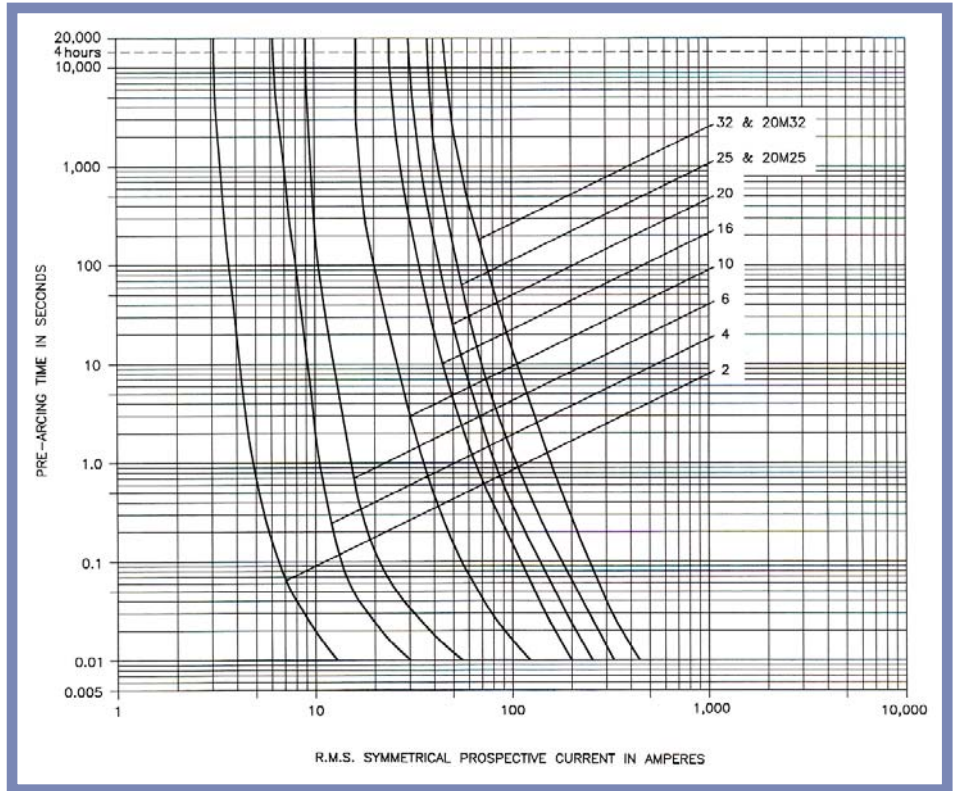

Type NIT I²t values

Current Rating Amp	Pre-Arcing I ² t (A ² sec)	Total I ² t (A ² sec) at	
		415V	550V
2	2.2	5.4	31
4	7.2	18	70
6	21	60	400
10	100	280	1,000
16	300	850	2,000
20	540	1,000	2,500
25 & 20M25	900	3,000	-
32 & 20M32	1,100	4,000	-

Type NIT Cut-off Current Characteristics

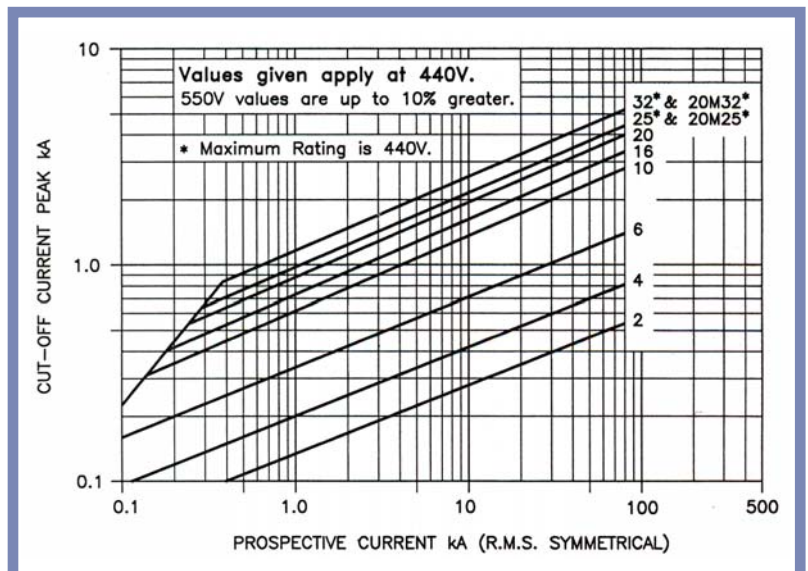

CHARACTERISTICS

Type 'T' Time/Current Characteristics 2-63 Amp (including gM ratings)

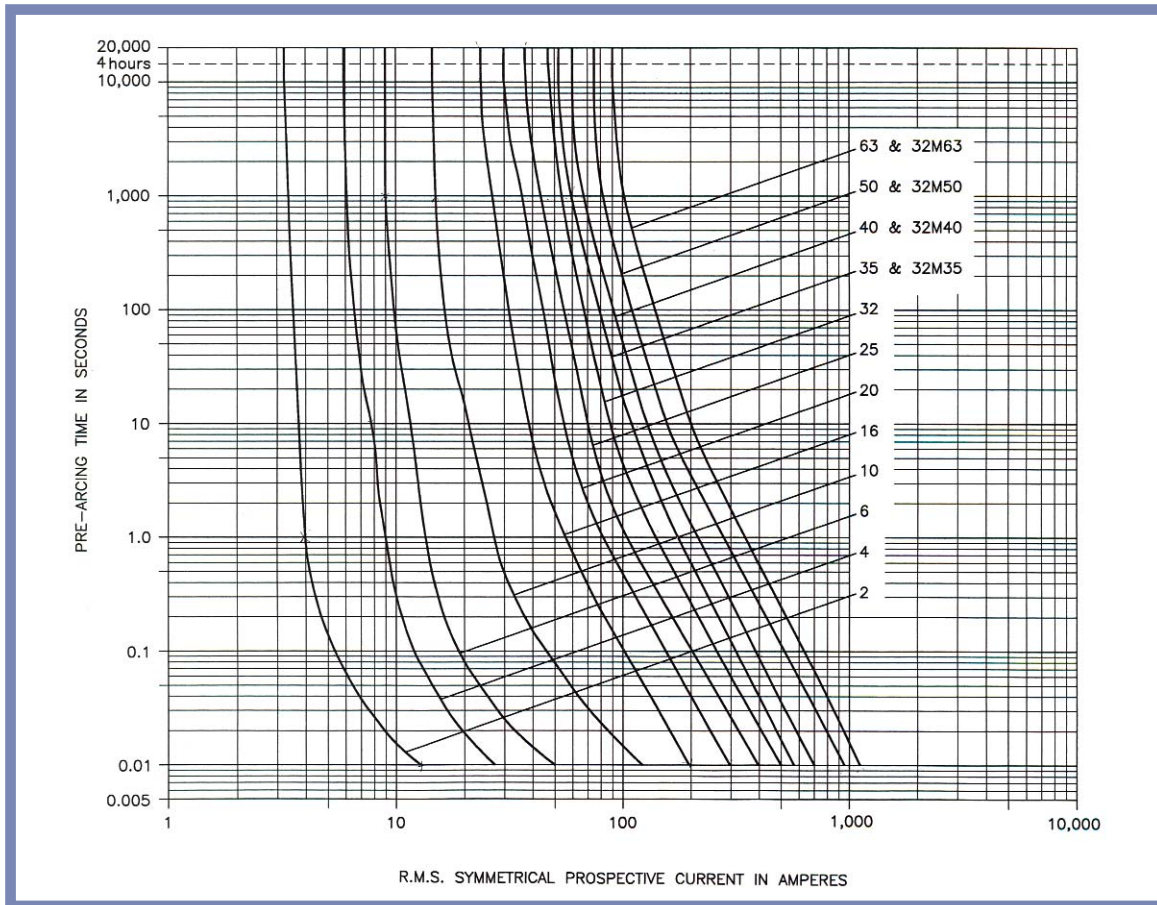

Type 'T' I²t values 2-63 Amp

Current Rating Amp	Pre-Arcing I ² t (A ² sec)	Total I ² t (A ² sec)		
		415V	550V	660V
2	2.2	5.5	7.4	15
4	7	18.5	23	50
6	21	60	80	150
10	100	280	370	700
16	250	550	740	1,800
20	540	1,100	1,400	2,500
25	850	1,850	2,300	3,700
32	1,600	3,400	5,400	8,700
35 & 32M35	2,700	5,300	8,000	15,000
40 & 32M40	4,000	8,500	11,000	20,500
50 & 32M50	6,300	13,500	18,500	28,000
63 & 32M63	11,000	24,000	36,000	50,000

- See pages 16 & 17 for cut-off current characteristics.



CHARACTERISTICS

Type 'T' Time/Current Characteristics 80-450 Amp (including gM ratings)

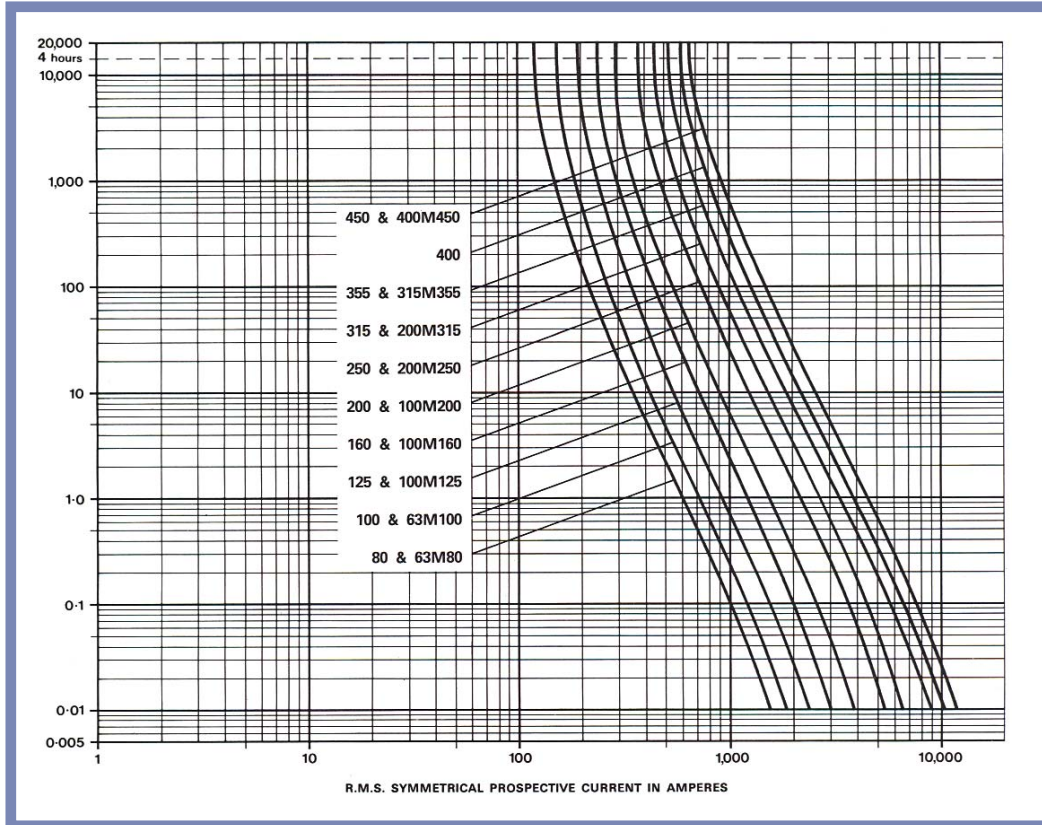

Type 'T' I²t values 80-450 Amp

Current Rating Amp	Pre-Arcing I ² t (A ² sec x 10 ³)	Total I ² t (A ² sec x 10 ³)		
		415V	550V	660V
80 & 63M80	14	40	52	66
100 & 63M100	17	60	80	100
125 & 100M125	25	85	110	140
160 & 100M160	62	160	210	270
200 & 100M200	105	260	330	430
250 & 200M250	200	550	700	870
315 & 200M315	300	800	1,050	1,350
355 & 315M355	500	1,400	1,850	2,250
400	640	1,800	2,500	3,000
450 & 400M450	800	2,200	3,000	3,800

CHARACTERISTICS

Type 'T' Time/Current Characteristics 500-1250 Amp (including gM ratings)

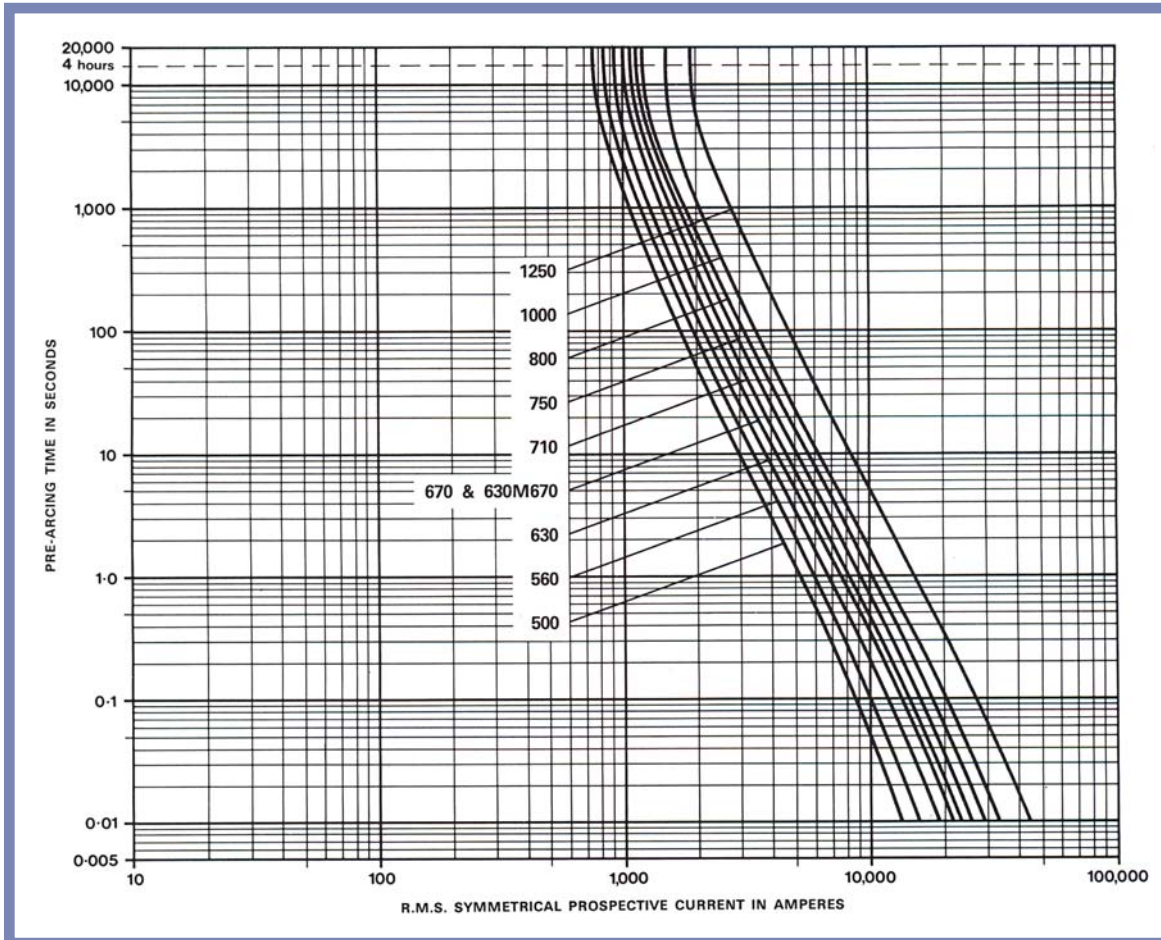

Type 'T' I²t values 500-1250 Amp

Current Rating Amp	Pre-Arcing I ² t (A ² sec x 10 ³)	Total I ² t (A ² sec x 10 ³)		
		415V	550V	660V
500	1,050	3,000	3,800	4,500
560	1,400	3,800	4,250	5,400
630	2,000	5,200	6,000	7,500
670 & 630M670	2,400	6,400	7,400	9,000
710	2,800	7,000	8,000	9,700
750	3,700	7,500	10,000	12,000
800	4,400	9,600	12,500	15,000
1,000	5,300	12,000	14,500	17,500
1,250	10,000	20,000	24,000	29,000



CHARACTERISTICS

Type 'T' Cut-off Current Characteristics 2-1250 Amp

To aid reference, alternate ratings have been shown on tables A & B.

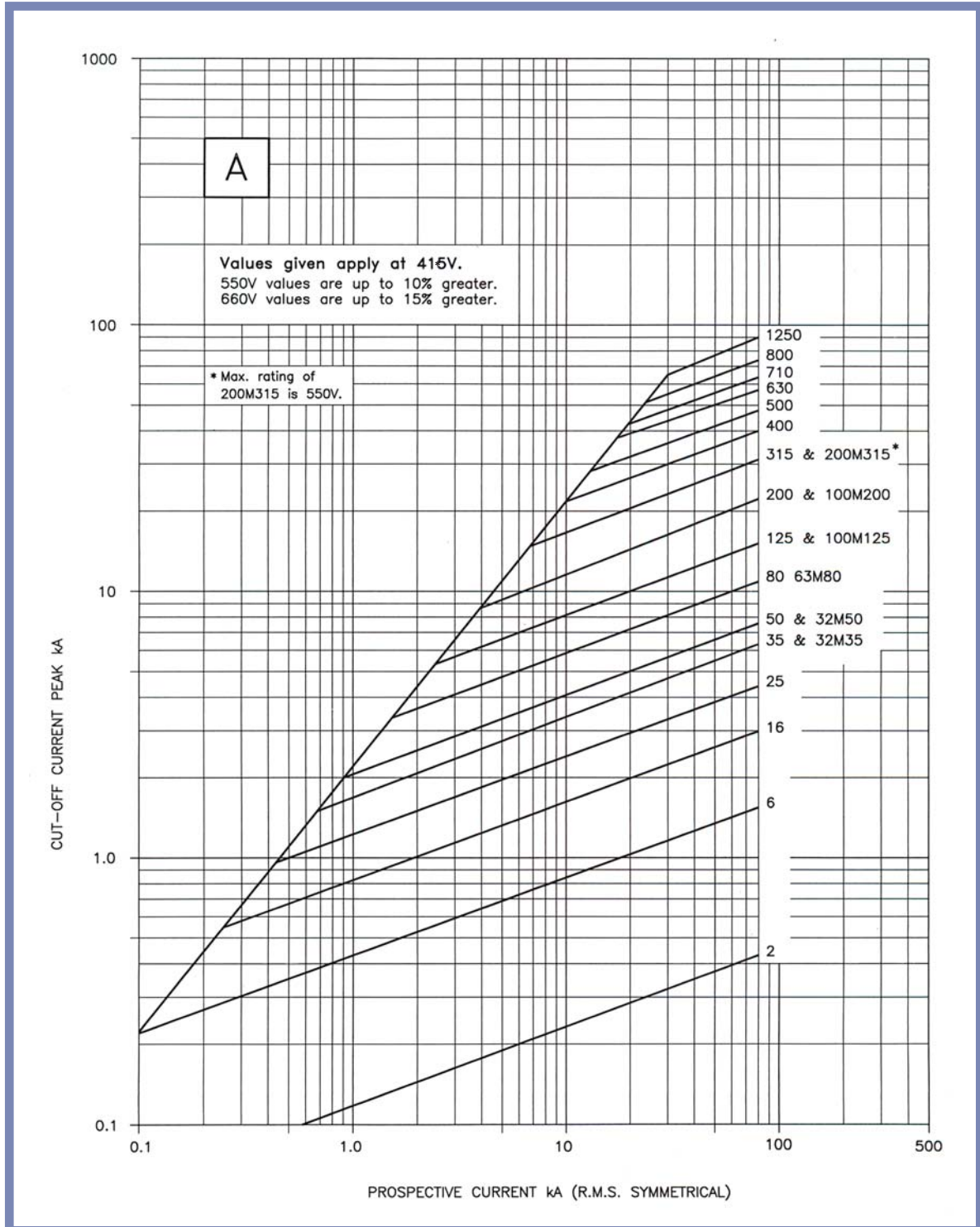

Type 'T' Cut-off Current Characteristics 2-1250 Amp

To aid reference, alternate ratings have been shown on tables A & B.

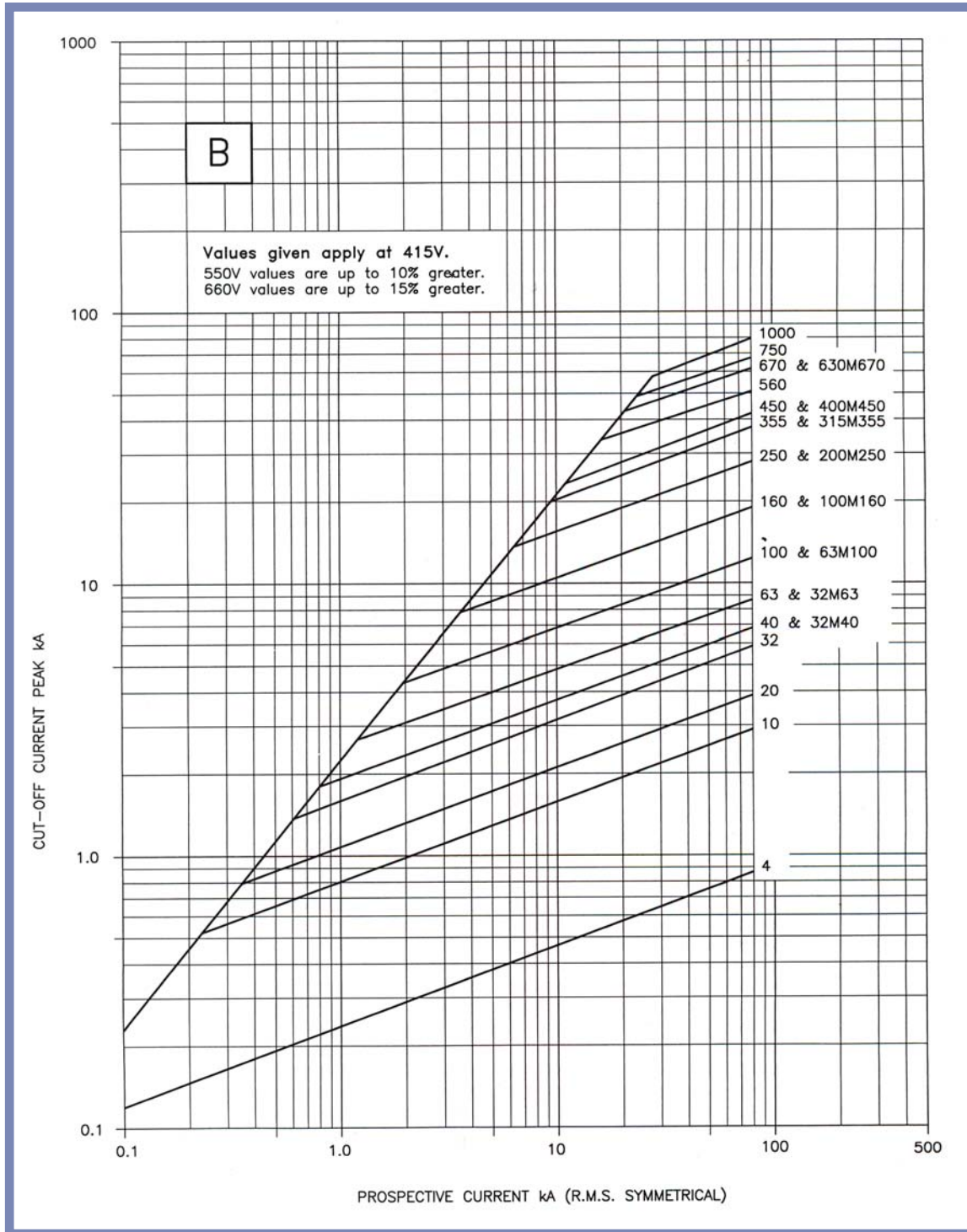



BS88-1 or 6:1988, IEC 269-1



ASTA **20** Certified

A.C. Performance

Current Rating	(A) 2-80
Voltage Rating ac	(V) up to 440
Breaking Capacity ac	(kA) 80

Breaking Capacity (AC)

The standard ratings are ASTA 20 certified to 80kA, 415 Volt*, to BS 88: Part 1 or Part 6: 1988 (IEC 269-1).

*SS types are certified at 16.5kA, 240 Volt, and the NS32M40 and ES63M80 at 80kA, 415 Volt.

Offset blade tag: Type SS

Current rating	Part Number	Max voltage rating ac
2A	SS2	240
4A	SS4	240
6A	SS6	240
10A	SS10	240
16A	SS16	240
20A	SS20	240

Offset blade tag: Type NS

Current rating	Part Number	Max voltage rating ac
2A	NS2	415
4A	NS4	415
6A	NS6	415
10A	NS10	415
16A	NS16	415
20A	NS20	415
25A	NS25	415
32A	NS32	415
32M40A	NS32M40	415

Offset blade tag: Type ES

Current rating	Part Number	Max voltage rating ac
40A	ES40	440
50A	ES50	440
63A	ES63	440
63M80A	ES63M80	415

Discrimination

'SAFECLIP' fuse links will discriminate with each other at fault levels up to their rated a.c. performance when the ratio between 'major' and 'minor' current ratings is 2:1 (See Application Notes.)

Application Notes

Short circuit energy limitation and discrimination

The designers of electrical equipment such as switches and contactors have to prove their products under the worst possible conditions (ie. At maximum breaking capacity, at 110% rated voltage, very low power factor, and with faults initiated at the most onerous points on the voltage wave), and they require relevant data from the fuse link manufacturer.

However, in service the short circuit fault conditions are usually less exacting than those produced in proving tests. In particular, the circuits are usually three-phase with relatively high power factor. In practice, therefore, the I²t values of 'SAFECLIP' fuse links are significantly less than those tabulated and they will discriminate with each other if the ratio between 'major' and 'minor' fuse links in series is 2:1. Where 'SAFECLIP' fuse links are used as the minor rating in series with a 'RED SPOT' range fuse link as the major rating then discrimination at 415/240 Volts will generally be achieved with a ratio of 1.6:1.

Offset blade tag: Safeclip

Type	Rating	A	B	D	E	G	H
SS	2 - 20	25.00	14.50	51.00	11.00	0.80	3.60
NS	2 - 32M40	35.50	14.50	62.00	11.00	0.80	3.60
ES	40 - 63M80	39.00	17.50	69.00	15.00	1.25	3.60

Dimensions in mm

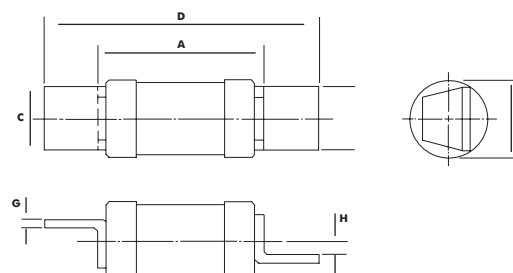

TIME/CURRENT CHARACTERISTICS

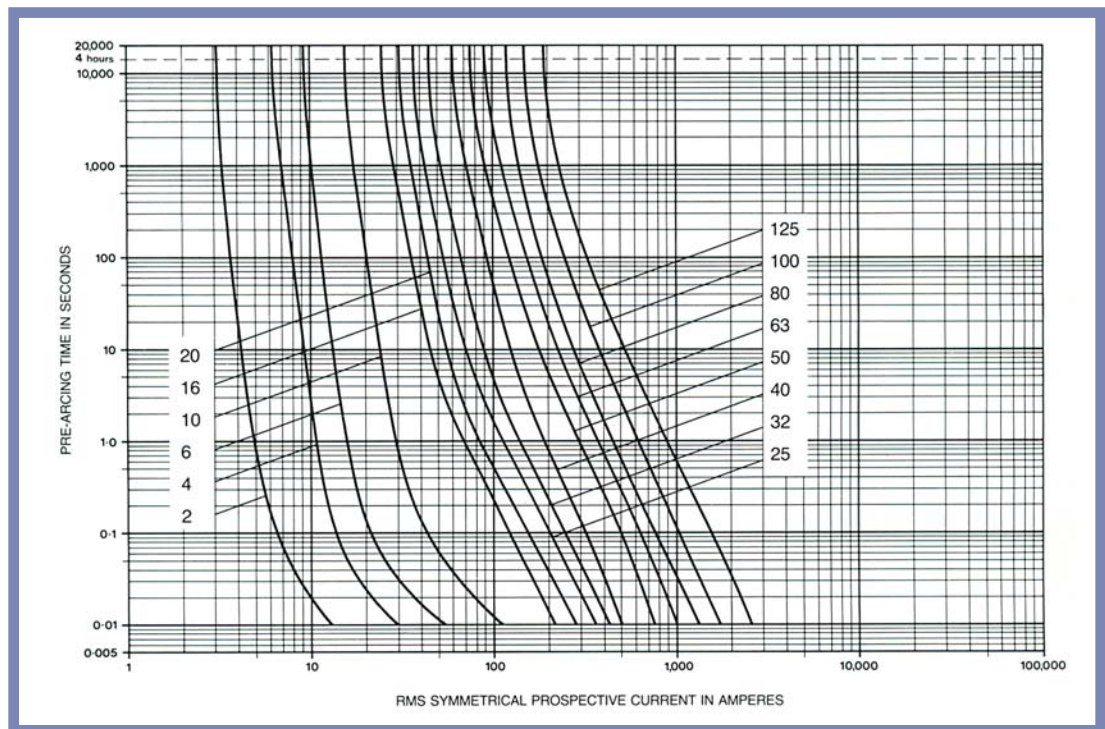

Type NS & ES

Current Rating (Amp)	Pre-Arcing I ² t (A ² sec)	Total I ² t at 415 Volt (A ² sec)	Total I ² t at 440 Volt (A ² sec)
2	2.2	9.5	11
4	7.2	30	33
6	22	92	100
10	170	650	700
16	200	800	950
20	360	1,200	1,500
25	650	2,500	2,900
32	600	3,500	4,050
40 & 32M40*	2,400	6,400	12,000
50	3,200	11,500	15,000
63	5,400	14,500	25,000
80 & 63M80*	6,000	24,000	38,000

* Maximum rating of 32M40 and 63M80 is 415 Volt.

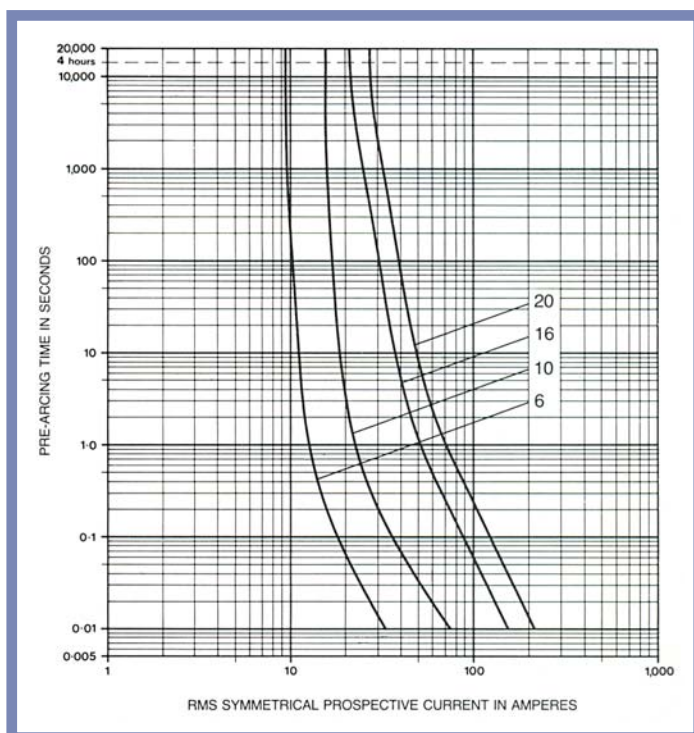

Type SS

Current Rating (Amp)	Pre-Arcing I ² t (A ² sec)	Total I ² t at 240 Volt (A ² sec)
2	2	4
4	7.5	15
6	30	85
10	50	150
16	140	1,400
20	300	1,700



J - TYPE FUSES

J-Type fuse-links are for use in AC electricity supply networks. They are installed in overhead line equipment, feeder pillars and link boxes. The range has been certified at a test recovery voltage of 110%. These fuse-links are therefore suitable for use on systems with voltages up to 457V AC.

The rated and tested voltage also ensures that the range meet all the transitional voltage requirements.

415V AC BS88 1988 Part 5
Breaking Capacity 80kA
ASTA 20 Certified
Utilisation category gU



Type	Rating Amp	Part Number
JF20-315A	20	JF20
	32	JF32
	40	JF40
	50	JF50
	63	JF63
	80	JF80
	100	JF100
	125	JF125
	160	JF160
	200	JF200
	250	JF250
315	JF315	

BS88: 1988 Part 5 Dimensions in mm

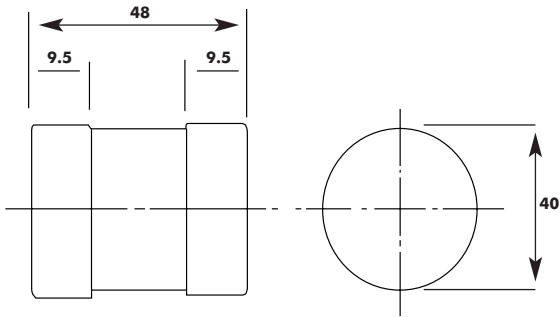

Type	Rating Amp	Part Number		
		Fixing Centres G		
		76mm	82mm	92mm
JH, JP, JS	20	JH20	JP20	
	32	JH32	JP32	
	40	JH40	JP40	
	50	JH50	JP50	
	63	JH63	JP63	
	80	JH80	JP80	JS80
	100	JH100	JP100	JS100
	125	JH125	JP125	JS125
	160	JH160	JP160	JS160
	200	JH200	JP200	JS200
	250	JH250	JP250	JS250
	315	JH315	JP315	JS315
	355		JP355	JS355
	400		JP400	JS400
	450		JP450	JS450
	500		JP500	JS500
	560		JP560	JS560
630		JP630	JS630	
800			JS800	

BS88: 1988 Part 5 Dimensions in mm

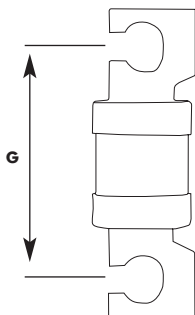

OPERATING CHARACTERISTICS TYPE J

Type J - Time/Current

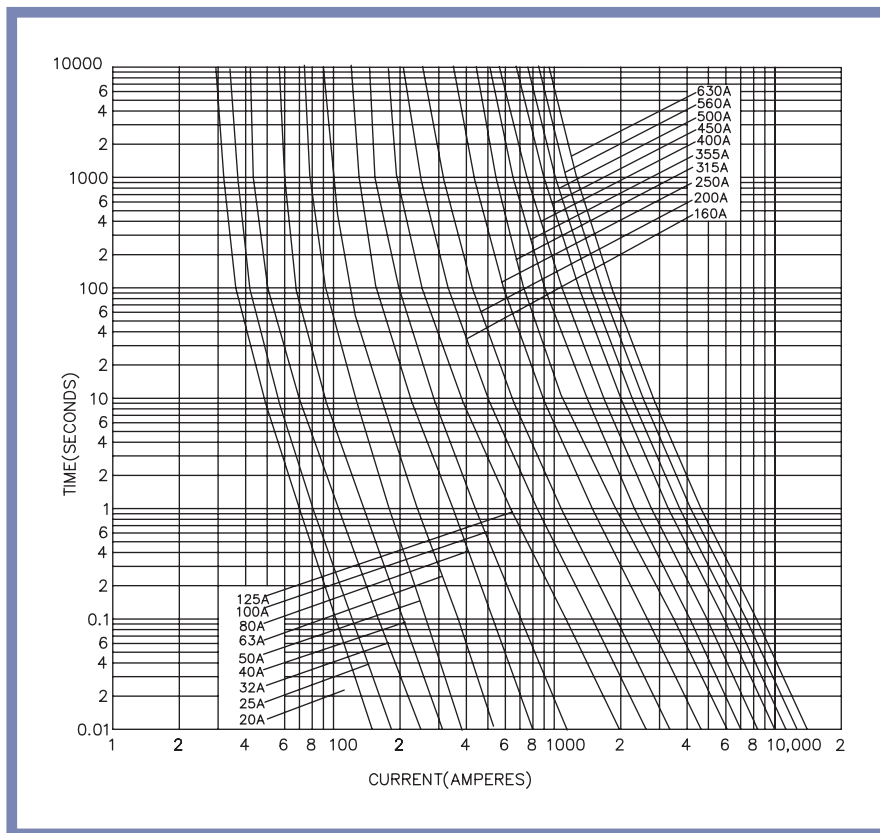

Type J - Cut-Off Current

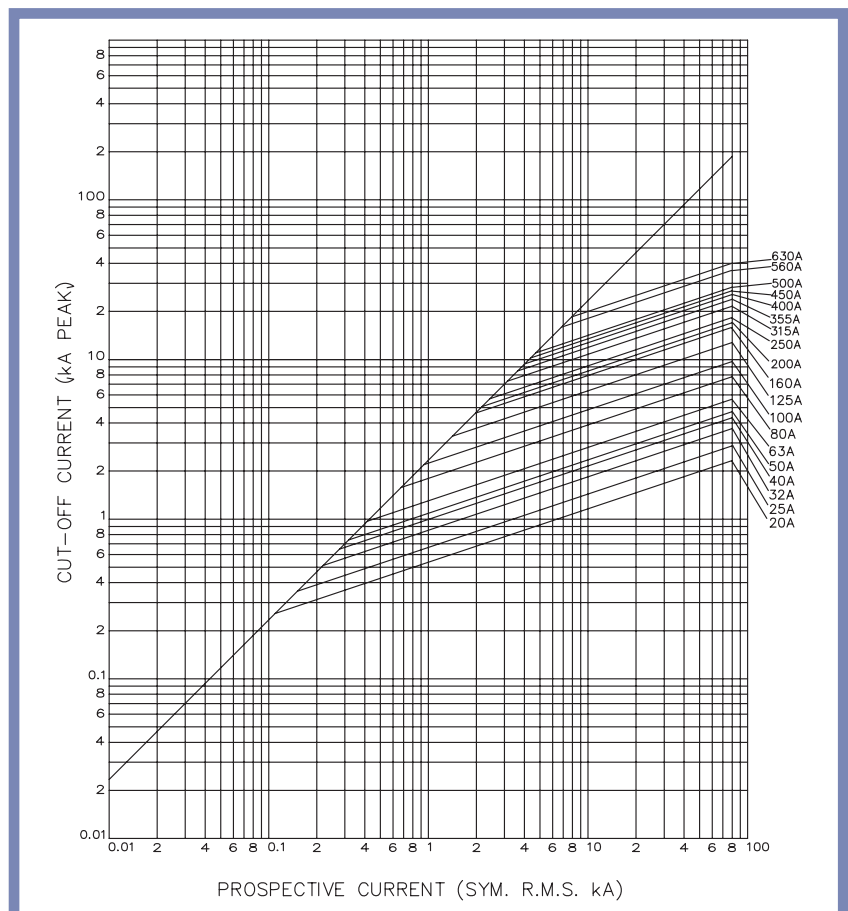



NH FUSES

500V AC gL-gG

Cd/Pb - Free

- Short circuit rating 120kA
- Conducting grip lugs
- Complies with IEC 60269-2, DIN 13620 parts 1 to 4, DIN VDE 0636 part 201
- Rated full range, general purpose for cable and line protection
- Size 4 for screw contact type base (NH4BASE)
- Size 4A fuses available for disconnect type mountings
- Other ratings available



Size	Rated Current (A)	Rated DC voltage (V DC)	Power Losses (W)	Catalogue Number	Part Number
000/C00	6	250	1.6	NHG00-006	D235661
	10		1.1	NHG00-010	E235662
	16		1.8	NHG00-016	F235663
	20		2.4	NHG00-020	G235664
	25		2.4	NHG00-025	H235665
	32		2.7	NHG00-032	J235666
	35		3.0	NHG00-035	K235667
	40		3.4	NHG00-040	L235668
	50		3.9	NHG00-050	M235669
	63		4.7	NHG00-063	N235670
00	80	250	5.7	NHG00-080	P235671
	100		6.7	NHG00-100	Q235672
1	125	440	8.4	NHG00-125	R235673
	160		10.6	NHG00-160	S235674
	63		6.2	NHG1-063	F235962
	80		7.1	NHG1-080	B235682
	100		8.7	NHG1-100	C235683
	125		11.0	NHG1-125	D235684
2	160	440	11.7	NHG1-160	E235685
	200		14.5	NHG1-200	F235686
	250		19.7	NHG1-250	H235688
	125		10.6	NHG2-125	J235689
	160		11.9	NHG2-160	K235690
	200		14.0	NHG2-200	L235691
3	250	440	19.1	NHG2-250	N235693
	315		24.0	NHG2-315	Q235695
	355		26.2	NHG2-355	R235696
	400		30.2	NHG2-400	S235697
	500		35.6	NHG2-500	T228522
	315		22.4	NHG3-315	T235698
4	355	440	23.5	NHG3-355	V235699
	400		30.1	NHG3-400	W235700
	500		44.0	NHG3-500	Z235703
	630		47.5	NHG3-630	A235704
4a	800	350	53.2	NHG3-800	V228523
	500		35.0	NHG4-500	X216542
	630		44.0	NHG4-630	W217576
	800		70.0	NHG4-800	E218090
	1000		85.0	NHG4-1000	H201694
4a	1250	350	93.0	NHG4-1250	C213994
	800		70	NHG4a-800	Y211437
	1000		83.3	NHG4a-1000	A219650
	1250		110.0	NHG4a-1250	J200637

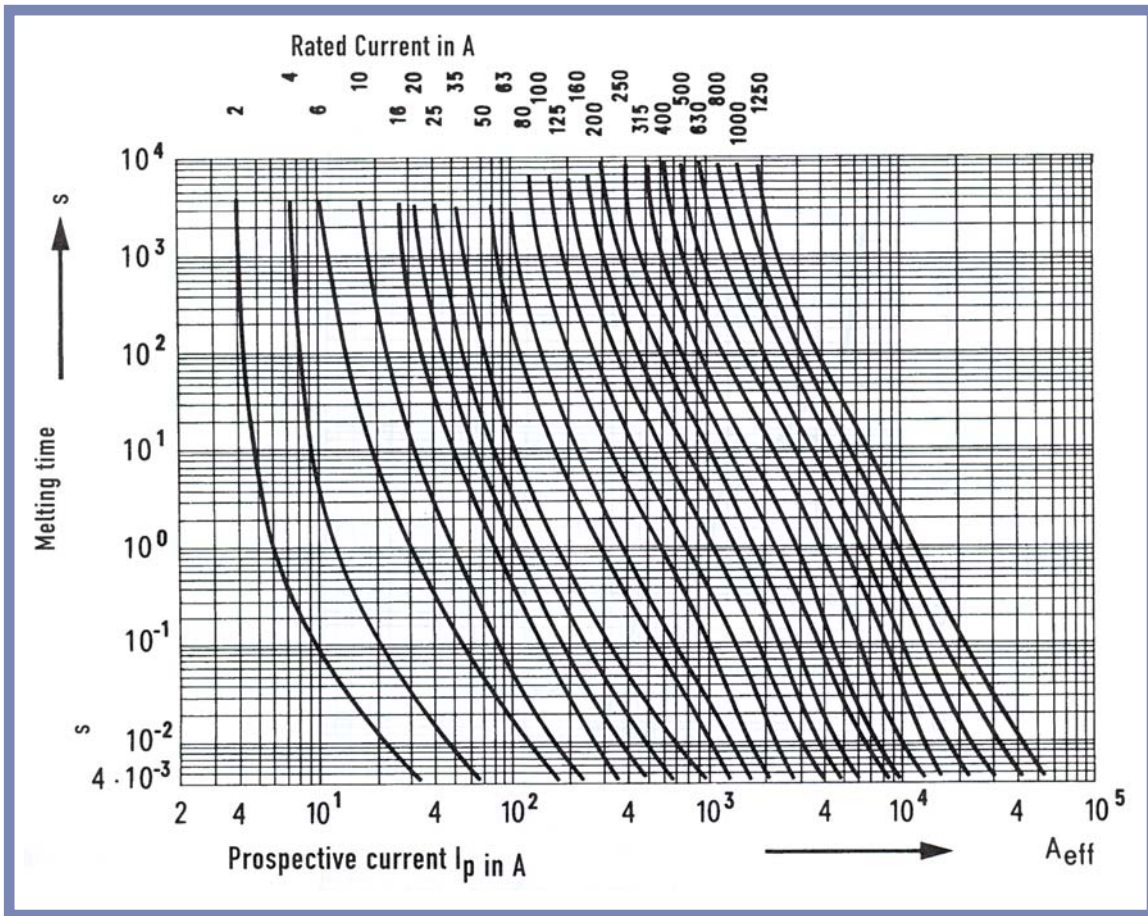

Peak let-thru current data

Size 000 to 4/4a, gl-gG, - 500V

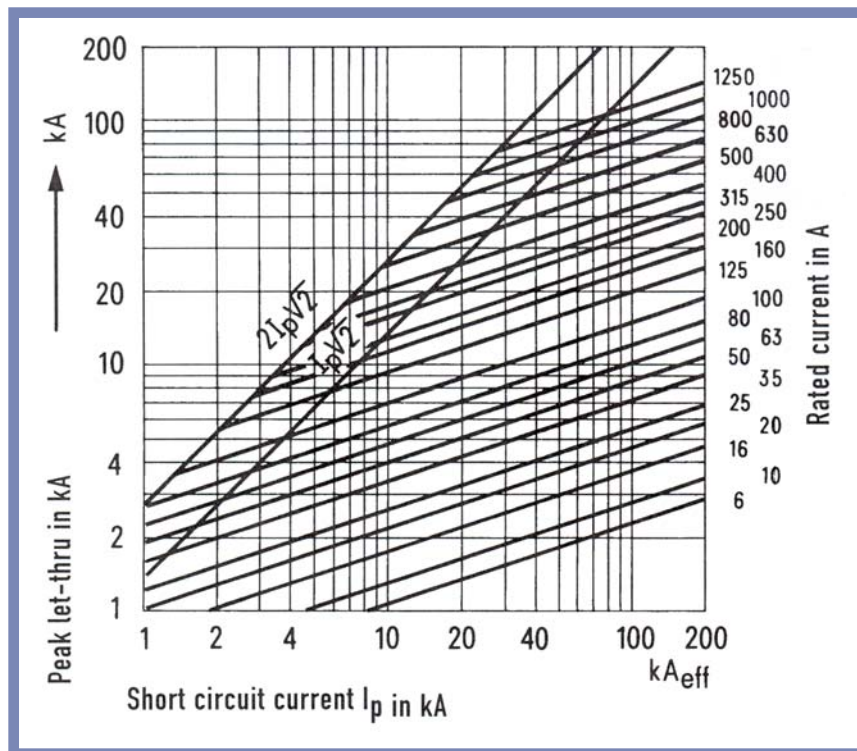

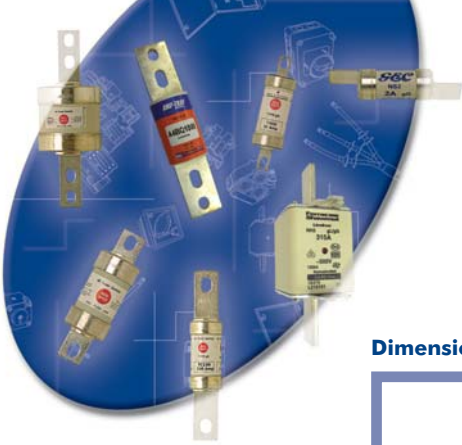

NH FUSE DIMENSIONS

Dimensions size 000 to size 4a

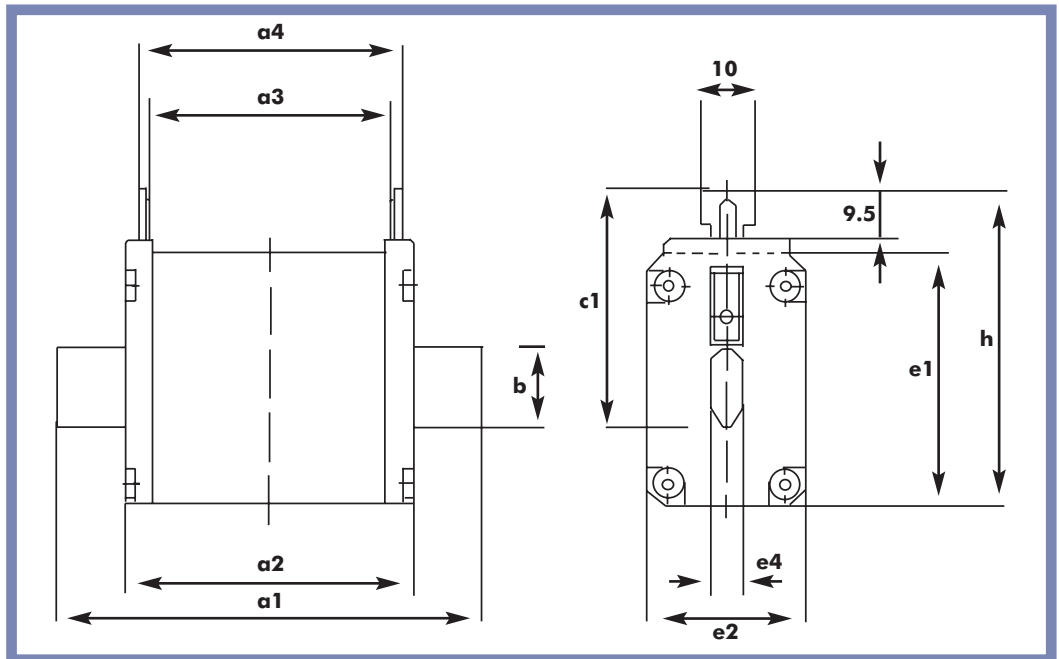

Dimensions size 4

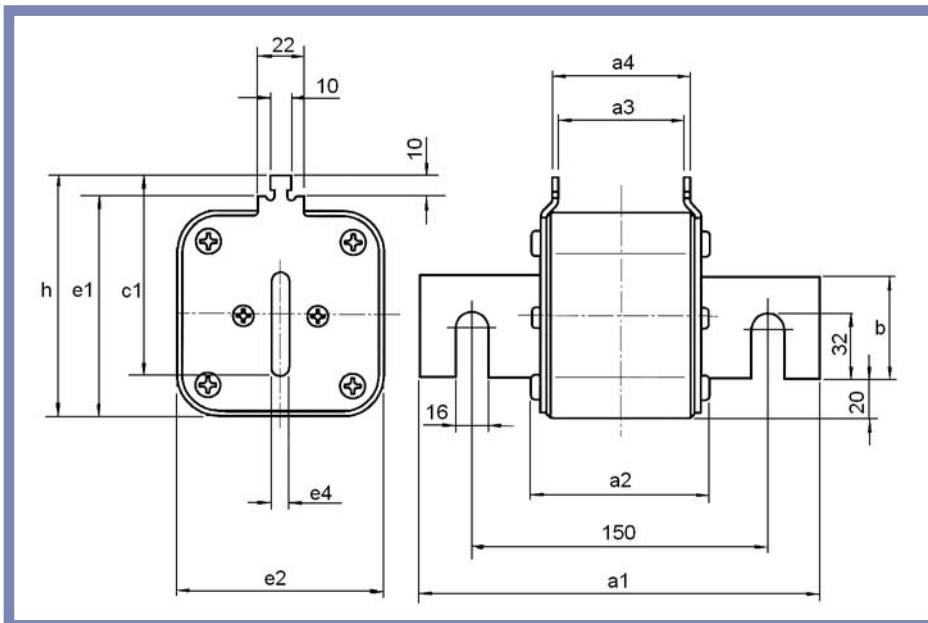

Rated I_N (A)		a1	a2	a3	a4	b	c1	e1	e2	e4	h
Current											
Standard 500V gG with non-isolated gripping lugs											
SIZE 000	2-100A	79.0	52.0	45.5	49.5	15.0	35.0	40.5	20.8	6.0	52.5
SIZE 00	125/160A	79.0	52.8	45.0	50.0	15.0	35.0	47.5	29.5	6.0	59.5
SIZE 1	63-100A	135.0	70.8	63.0	68.0	15.0	40.0	47.5	29.5	6.0	64.5
SIZE 1	125-250A	135.0	70.8	63.0	68.0	20.0	40.0	52.5	39.5	6.0	64.5
SIZE 2	125-250A	150.0	72.3	63.0	68.0	20.0	48.0	52.5	39.5	6.0	72.5
SIZE 2	300-500A	150.0	72.3	63.0	68.0	26.0	48.0	60.0	51.0	6.0	72.0
SIZE 3	250-400A	150.0	72.3	63.0	68.0	26.0	60.0	60.0	51.0	6.0	83.5
SIZE 3	425-800A	150.0	72.3	63.0	68.0	33.0	60.0	74.0	70.0	6.0	86.0
SIZE 4	500-1250A	200.0	85.0	62.0	68.0	49.0	86.0	108.0	90.0	8.0	117.5
SIZE 4a	800-1250A	200.0	85.0	84.0	90.0	49.0	86.0	108.0	90.0	6.0	117.5

CLASS L POWER FUSES

PUT THE HIGHEST CURRENT-LIMITATION . . . AT YOUR SERVICE.

Amp-trap 2000® A4BQ fuses are 20% more current limiting than any other Class L fuse on the market. When correctly coordinated, they bring a superior level of protection to service entrance equipment. Downstream circuit components have maximum protection against short circuit let-thru current. A4BQ's built-in, 4-second time delay characteristic (at 500% of rated current) accommodates harmless inrush currents with no nuisance opening.

Features / Benefits

Fastest operation under short circuit conditions: Let-thru currents are typically 20% lower with a corresponding let-thru energy (clearing I²t) up to 40% lower than the next fastest Class L fuse.

Time delay for high inrush loads such as motors and transformers, without nuisance opening.

300kA interrupting rating - self-certified, UL witnessed tests.

Most current limiting for lowest peak let-thru current; even at fault currents up to 300kA.

Pure silver links ensure lowest let-thru current and longer fuse life.

Easy 2-to-1 selectivity for prevention of nuisance shutdowns and "blackouts":

Rejection-style design prevents replacements errors.

High-visibility orange label gives instant recognition.

Reduced inventory because A4BQ can replace all older types of Class L fuses now in service.

Metal-embossed date and ref number for traceability and lasting identification.

Fibreglass body provides dimensional stability in harsh industrial settings

High-grade silica filler ensures fast arc quenching.

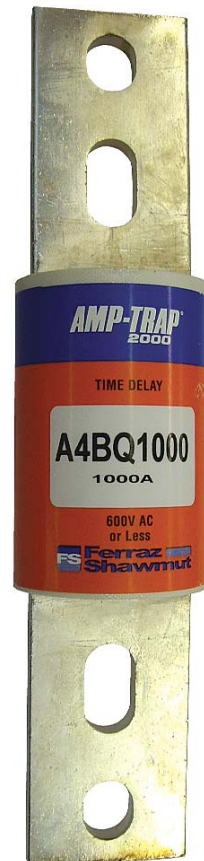

Ratings

AC: 100 to 6000A

600VAC, 200kA I.R. (self certified for 600VAC, 300kA I.R., UL witnessed)

4-second delay at 500% rating

Note: 100-600A ratings are non-listed

DC: 601 to 3000A

500VDC, 100kA I.R.

Highlights:

Time Delay
Industry's Most
Current-Limiting
Class L Fuse
Pure Silver Elements
AC & DC Rated

Applications:

Mains, Feeders
Large Motors
Lighting, Heating & General Loads
Circuit Breaker Back-up
DC Rate: UPS DC Links, Battery Disconnects, Other DC Applications

Approvals:

UL Listed to Standard
248-10 (601-6000A)
DC Listed to UL Standard
198L (601-3000A)
CSA Certified to Standard C22.2 No.
248.10 (601-6000A)
IEC 269-2-1

Safety Note: Class L fuses are dimensioned for one-way interchangeability. A Class L fuse of any lower ampere rating can be substituted for a give Class L fuse.

*Note UL Listed or CSA Certified

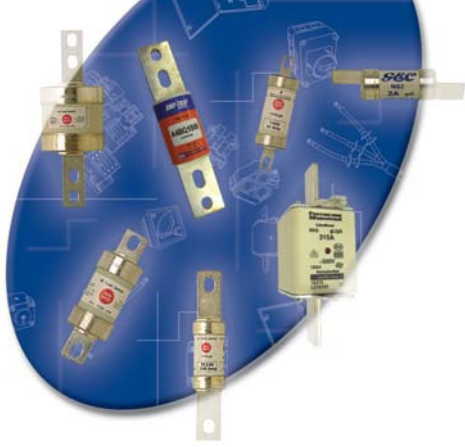

CLASS L POWER FUSES

Standard Fuse Ampere Ratings

Ampere Rating	Catalog Number	Ampere Rating	Catalog Number	Ampere Rating	Catalog Number	Ampere Rating	Catalog Number
100	A4BQ100	500	A4BQ500	1000	A4BQ1000	2000	A4BQ2000
150	A4BQ150	600	A4BQ600	1200	A4BQ1200	2500	A4BQ2500
200	A4BQ200	601	A4BQ601	1350	A4BQ1350	3000	A4BQ3000
250	A4BQ250	650	A4BQ650	1400	A4BQ1400	3500	A4BQ3500
300	A4BQ300	700	A4BQ700	1500	A4BQ1500	4000	A4BQ4000
350	A4BQ350	750	A4BQ750	1600	A4BQ1600	5000	A4BQ5000
400	A4BQ400	800	A4BQ800	1800	A4BQ1800	6000	A4BQ6000
450	A4BQ450	900	A4BQ900				

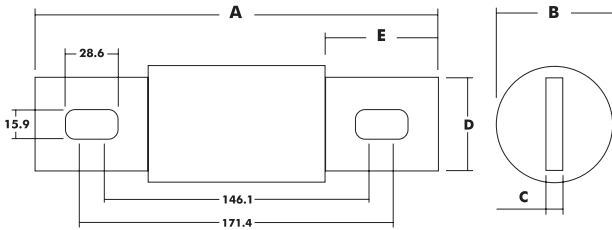

Fig 1

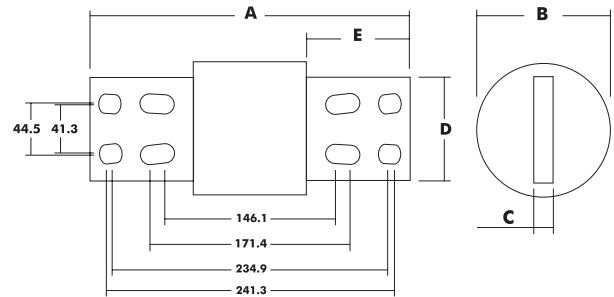

Fig 3

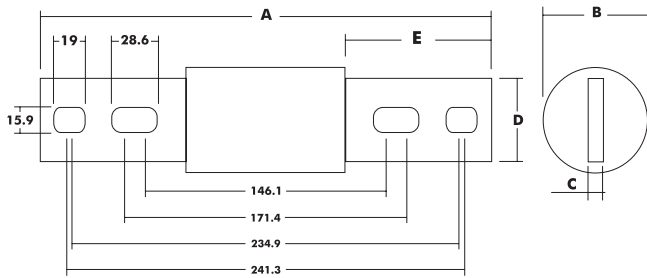

Fig 2

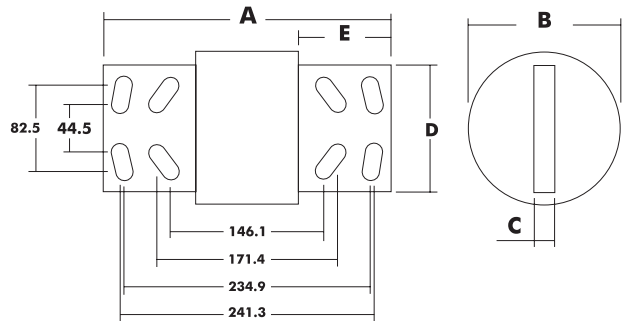

Fig 4

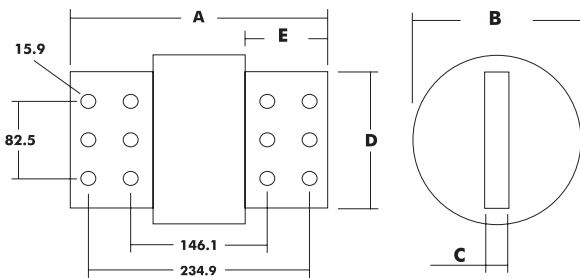

Fig 5

AMPERE RATING	Figure (Fig)	A mm	B mm	C mm	D mm	E mm
100-600*	1	219.0	51.0	8.0	41.0	61.0
601-800	1	219.0	63.5	9.5	50.8	61.0
801-1200	2	273.0	63.5	9.5	50.8	88.0
1201-1600	2	273.0	76.2	11.1	60.3	88.0
1601-2000	2	273.0	88.9	12.7	69.8	88.0
2001-2500	3	273.0	114.3	19.0	88.9	88.0
2501-3000	3	273.0	127.0	19.0	101.6	88.0
3001-4000	4	273.0	146.1	19.0	120.7	88.0
4001-5000	5	273.0	158.8	25.4	133.3	88.0
5001-6000	5	273.0	181.0	25.4	146.1	88.0

CLASS L POWER FUSES

Available Fault RMS AMPS	601		800		1000		1200		1600		2000		2500		3000		4000		5000		6000	
	RMS	Ip	RMS	Ip	RMS	Ip	RMS	Ip	RMS	Ip	RMS	Ip	RMS	Ip	RMS	Ip	RMS	Ip	RMS	Ip	RMS	Ip
10,000	7.4	17	8.7	20	10	23	10	23	10	23	10	23	10	23	10	23	10	23	10	23	10	23
15,000	8.3	19	10	23	12	27	13	30	15	35	15	35	15	35	15	35	15	35	15	35	15	35
20,000	9.1	21	11	25	13	29	14	33	17	39	20	46	20	46	20	46	20	46	20	46	20	46
25,000	9.8	23	12	27	13	31	15	35	18	42	22	50	25	58	25	58	25	58	25	58	25	58
30,000	10	24	13	29	14	33	16	37	20	45	23	53	29	66	30	69	30	69	30	69	30	69
35,000	11	25	13	30	15	35	17	39	20	47	24	56	30	69	35	81	35	81	35	81	35	81
40,000	12	27	14	32	16	37	18	41	21	49	25	58	31	72	36	83	40	92	40	92	40	92
50,000	13	29	15	34	17	40	19	44	23	53	27	63	34	78	39	89	48	111	50	115	50	115
60,000	13	30	16	36	18	42	20	47	25	57	29	67	36	83	41	94	51	118	60	138	60	138
80,000	14	33	17	40	20	46	23	52	27	62	32	73	40	91	45	104	57	130	67	153	77	176
100,000	16	36	19	43	22	50	24	56	29	67	34	79	43	98	49	112	61	140	72	165	83	190
150,000	18	41	21	49	25	57	28	64	33	77	39	90	49	112	56	128	70	160	82	189	94	217
200,000	20	45	24	54	27	63	31	71	37	84	43	100	53	123	61	141	77	176	90	208	104	239

The current limiting effect of A4BQ Class L fuses is presented in the table above. This table correlates actual fuse peak let-thru currents with equal value peak currents reached in the first half cycle (worst case) of short circuits in unfused circuits. The let-thru current is expressed as "Apparent RMS Symmetrical Amperes" in order to be more useful for practical applications. The currents are based on an assumed 15% power factor.

Example: An A4BQ1200, when applied in a circuit with 40,000 RMS symmetrical amperes available, will limit that current during a short circuit, to an apparent 18,000 RMS symmetrical amperes. Under this condition, any equipment being protected would be subjected to only 18,000 RMS amperes.



CLASS L POWER FUSES

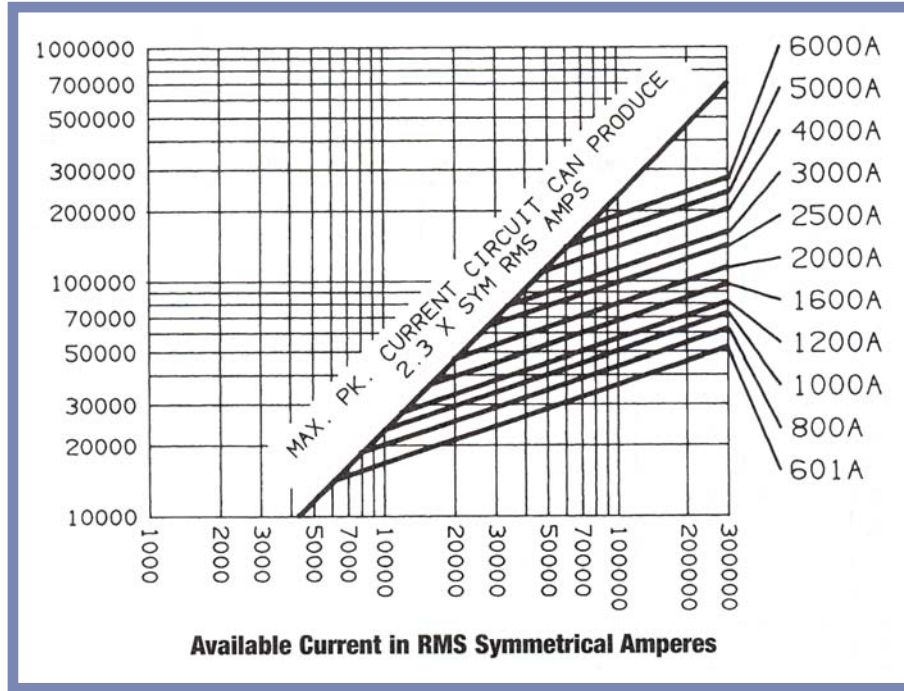

Melting time - current data

600V Fuses

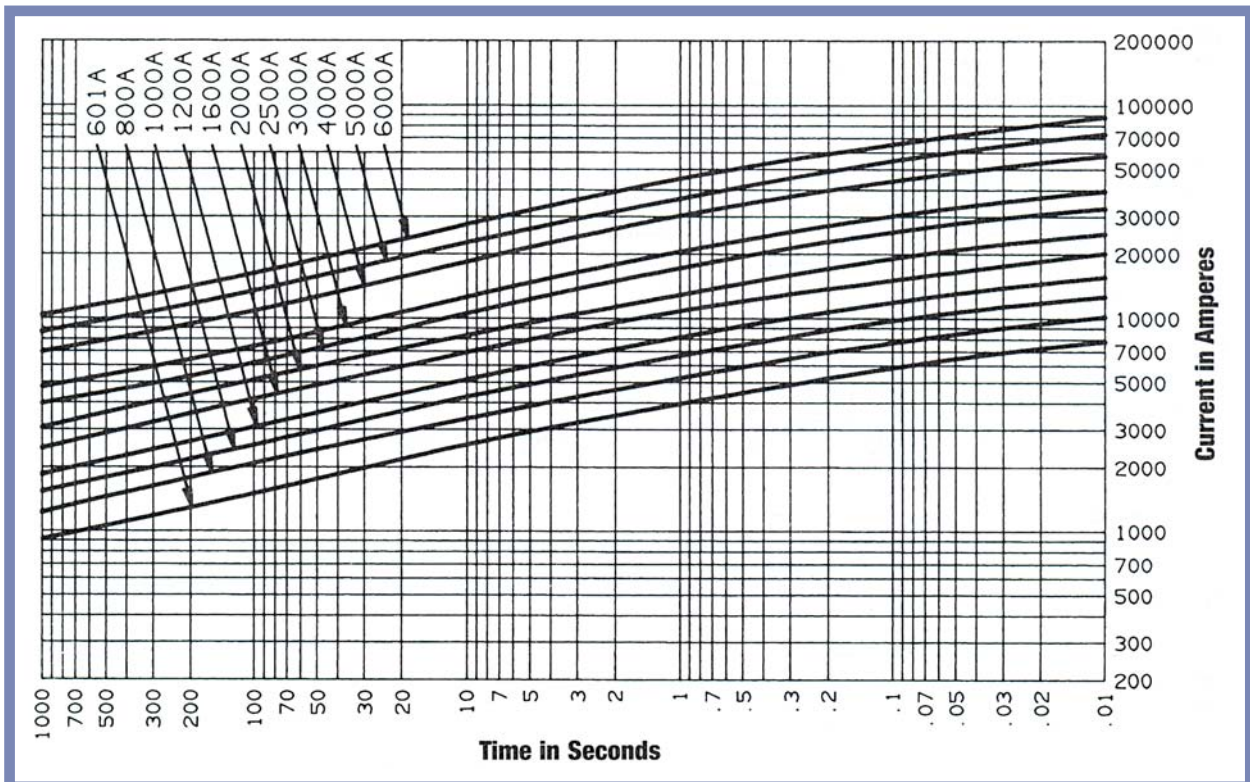

OTHER IPD FUSEGEAR PRODUCTS

Red spot Fuse Fittings up to 660V AC

- World leading Red Spot quality
- Smallest BS88 bolt-in fuse holders available
- Fully shrouded for personal safety
- Current ratings 20 to 400A



Safe Clip up to 550V AC

- 32A and 63A to suit NS and ES fuse series
- Fuse carrier moulded from tough flame retardant material with Integral DIN rail mounting
- Full shrouding and complete compliance with the direct contact electric shock requirements.



MV Fuse-links and bases up to 36kV

- Back-up fuse-links for the short circuit protection of distribution transformers
- From 1A up to 200A



Service Fuses and Fittings up to 500V AC

- 100A for Domestic and Light Commercial
- Front wire and Back wire with intrusion barriers if required
- Fuse from 20A up to 100A



Semiconductor Fuses up to 1250V AC

- BS88 Part 4
- UL American Pattern
- DIN Square body



Modular Fuses and Fittings up to 690V AC

- Fuse fittings available in 32A, 50A & 125A ratings
- Fuse-links 05.A up to 125A
- DIN rail mountable to standard DIN profile
- Conform to IEC269-2.



Traction Fuses and Fittings

- BS pattern 1200V AC traction fuse-links from 2A up to 400A
- DIN square body 1200V AC from 2A up to 500A
- US ferrule 1500V fuses and bases up to 63A





National Customer Support Centre

Tel: 1300 556 601 Fax: 1300 550 187 www.ipdgroup.com.au

