

Haier

OPERATION MANUAL SPLIT TYPE ROOM AIR CONDITIONER

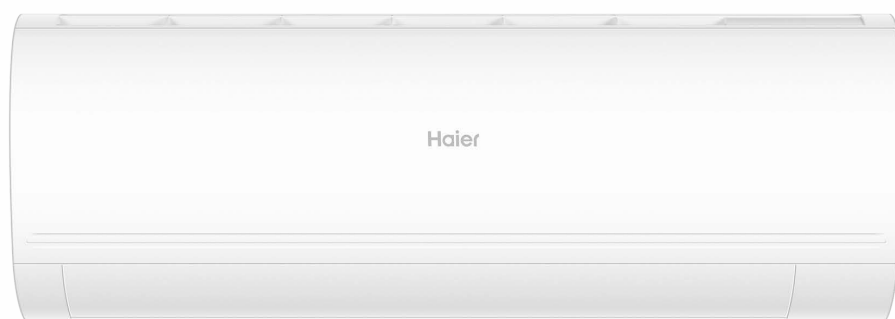

AS09PBMHRA

AS12PBMHRA

AS18PCMhRA

AS24PEMHRA

AS25TBMHRA

AS35TBMHRA

AS50TCMHRA

AS71TEMHRA

- Please read this operation manual before using the air conditioner.

Keep this operation manual for future reference.

This appliance is filled with R32.

0011530588



Parts and Functions

Indoor Unit

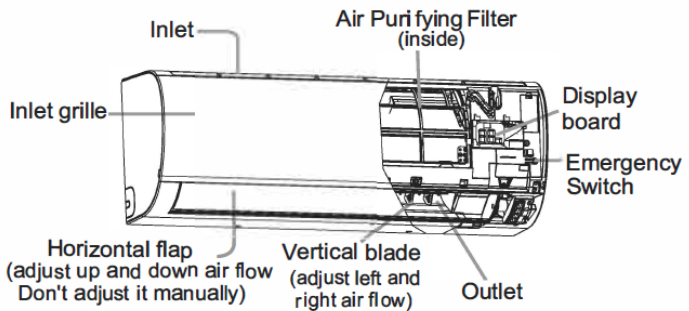

Control the lighting and extinguishing of the indoor LED display board.

Display board

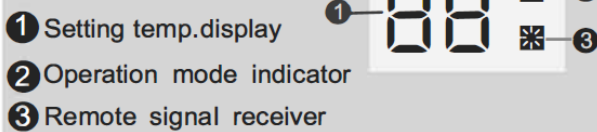

Actual inlet grille may vary from the one shown in the manual according to the product purchased

Outdoor Unit

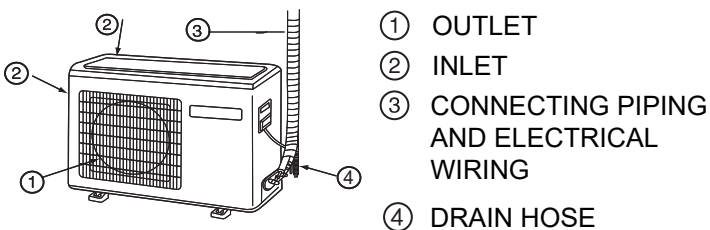

WiFi Setup

If your Air Conditioner (AC) has a Connected Appliance Information label located under the front cover as shown below, your AC is WiFi Connect Enabled. A WiFi communication card is built into the product allowing it to communicate with your smart phone for remote monitoring, control and notifications. Please visit www.haier.com.au/smart or www.haier.co.nz/smart to learn more about connected appliance features, and to learn what connected appliance apps will work with your smart phone.

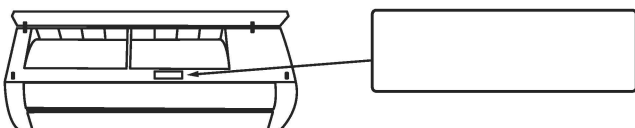

Remote controller

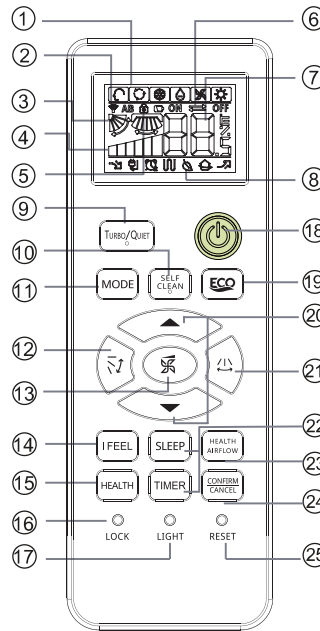

8. Additional functions display

Operation mode	QUIET	SLEEP	Supplemented electrical heating	HEALTH	TURBO
Remote controller					

- 9. TURBO/QUIET button
- 10. SELF-CLEAN button
- 11. MODE button
- 12. SWING UP/DOWN button
- 13. FAN SPEED button
- 14. I FEEL button
- 15. HEALTH button
- 16. LOCK button
- 17. LIGHT button
- Control the lighting and extinguishing of the indoor LED display board.
- 18. POWER ON/OFF button
- 19. ECO button
- 20. TEMP button
- 21. SWING LEFT/RIGHT button
- 22. TIMER/SLEEP button
- 23. HEALTH AIRFLOW button
- Function: Healthy airflow upward
→ Healthy airflow downward →
Present position.

1. Mode display

Operation mode	AUTO	COOL	DRY	FAN	HEAT
Remote controller					

2. Signal sending display

3. SWING display

4. FAN SPEED display



5. LOCK display

6. TIMER OFF display

7. TEMP display

- 24. CANCEL/CONFIRM button
- Function: Setting and cancel to the timer and other additional functions.
- 25. RESET button
- When the remote controller appears abnormal, use a sharp pointed article to press this button to reset the remote.

Note: Capacity may decrease when Energy control mode is selected

Loading of the battery

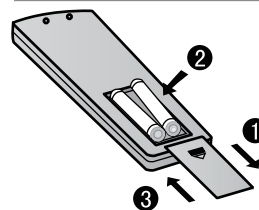

- 1 Remove the battery cover.
- 2 Load the batteries as illustrated. 2 AAA batteries, resetting key (cylinder).
- 3 Be sure that the loading is in line with the "+" and "-".

Note:

- The distance between the signal transmission head and the receiver should be within 7m without any obstacle.
- Fluorescent lamp or wireless telephone may disturb the remote controller signals, so move the controller closer to the indoor unit if you experience remote controller issues.
- Blank display or unclear display during operation indicates the batteries have been depleted. Please change batteries.
- If the remote controller is abnormal during operation, please remove the batteries and reload several minutes later.

Operation

Base Operation

Remote controller

1. Unit start

Press ON/OFF on the remote controller, unit starts.

2. Select operation mode

COOL : Cooling mode
HEAT : Heating mode
DRY : Dehumidification mode
FAN : Air supply mode
AUTO: Automatic mode

3. Select temp. setting

Press ▲ / ▼ button

▲ Every time the button is pressed, temp. setting increase 1°C, if kept depressed, it will increase rapidly.

▼ Every time the button is pressed, temp. setting decreases 1°C, if kept depressed, it will decrease rapidly.

Select a desired temperature.

4. Fan speed selection

Press FAN button. For each press, fan speed changes as follows:

Remote controller:

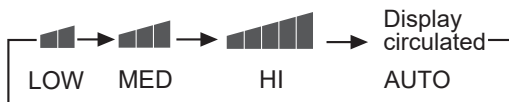

NOTE:

Air conditioner is running under displayed fan speed. When FAN is set to AUTO, the air conditioner automatically adjusts the fan speed according to room temperature.

Operation Mode	Remote Controller	Note
AUTO		Under the mode of auto operation, air conditioner will automatically select Cool or Heat operation according to room temperature. When FAN is set to AUTO, the air conditioner automatically adjusts the fan speed according to room temperature.
COOL		Cooling only unit do not have displays and functions related with heating
DRY		In DRY mode, when room temperature becomes lower than temp. setting +2°C, unit will run intermittently at LOW speed regardless of FAN setting.
HEAT		In HEAT mode, warm air will blow out after a short period of the time due to cold-draft prevention function.
FAN		In FAN operation mode, the unit will not operate in COOL or HEAT mode but only in FAN mode, AUTO is not available in FAN mode. And temp. setting is disabled. When FAN is set to AUTO, the air conditioner automatically adjusts the fan speed according to room temperature. In FAN mode, SLEEP operation is not available.

Emergency operation and test operation

Emergency Operation:

- Use this operation only when the remote controller is defective or lost.
- When the emergency operation switch is pressed, the "Pi" sound is heard once, which means the start of this operation.
- In this operation, the system automatically selects the operation modes, cooling or fan or heat, according to the room temperature.

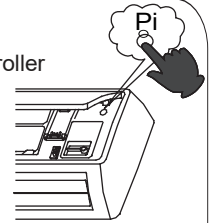

Room temperature	Operation mode	Designated temperature	Timer mode	Air flow
ABOVE 23°C	COOLING	26°C	NO	AUTOMATIC
BELOW 23°C	HEAT	23°C	NO	AUTOMATIC

(Cooling only unit) Room temperature	Operation mode	Designated temperature	Timer mode	Air flow
BELOW 23°C	FAN	26°C	NO	AUTOMATIC

- It is impossible to change the settings of temp. and fan speed, It is also not possible to operate in timer or dry mode.

Test operation:

Test operation switch is the same as emergency switch.

- Use this switch in the test operation when the room temperature is below 16°C, do not use it in the normal operation.
- Continue to press the test operation switch for more than 5 seconds. After you hear the "Pi" sound twice, release your finger from the switch: the cooling operation starts with the air flow speed "Hi".
- Under this operation mode, the fan motor of indoor unit will run in high speed.

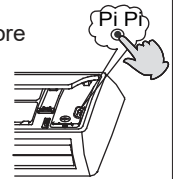

Air Flow Direction Adjustment

1. Status display of air flow

Vertical flap

Pos.1 (Auto swing)

Pos.2 No initial state displayed on remote controller, the vertical flap will be fixed on the current position.

2. Left and right air flow adjustment

For each press of button, remote controller displays as follows:
remote controller:





Cautions:

- When adjusting the flap by hand, turn off the unit.
- When humidity is high, condensate water might occur at air outlet if all vertical louvers are adjusted to left or right.
- It is advisable not to keep horizontal flap at downward position for a long time in COOL or DRY mode, otherwise, condensate water might occur.

Operation

TIMER ON/OFF Operation

1. In remote controller turn-off mode
Press TIMER button, the remote controller will show "ON", after 10 seconds the time display will be blank.
2. In remote controller turn-on mode
Press TIMER button, the remote controller will show "OFF", after 10 seconds the time display will be blank.
3. Press TIMER button to set time
Press the button for each time, setting time in the first 12 hours increased by 0.5 hour every time, after 12 hours, increase by 1 hour every time.
If the button is kept pressed, time will change quickly.
4. Confirm timer setting
After adjusting the time, press  button and confirm the time ON or OFF button will not flash any more.
5. Cancel timer setting
Press the  button the time display eliminated.

Note:



After replacing batteries or a power failure happens, time setting should be reset.

HEALTH Operation

Press HEALTH button, the remote controller will show  and then achieve to the health function. When cancel the function, please press again this HEALTH button.

NOTE: (This function is unavailable on some models)

I FEEL Operation

1. Only for cooling, heating or auto mode (other modes cannot be implemented).
2. Place the remote controller within the acceptable range of air conditioner. Press the "  " button, the remote control display the "  ". The remote controller sends the circulation temperature data to the indoor unit every 3 minutes, and the air conditioner runs according to this data.
3. Exit I FEEL mode when power off or press button or switch other modes.

TURBO/QUIET Operation

1. TURBO Operation

When you need rapid heating or cooling, you can use this function. Press TURBO/QUIET button, the remote controller will show , and then achieve to the turbo function. Press this TURBO/QUIET button twice, the turbo function will be cancelled.

2. QUIET Operation

You can use this function when silence is needed for rest or reading. Press TURBO/QUIET button twice, the remote controller will show , and then achieve to the quiet function. Press again this TURBO/QUIET button, the quiet function will be cancelled.

Note:

During POWER operation, in rapid COOL mode, the room will show inhomogeneous temperature distribution. Long period QUIET operation will cause effect of not too cool or not too warm.

ECO Operation

1. Third-gear power is the function of energy saving. When entering this mode, the remote controller has the power saving symbol "  ".
 2. Press this button to start the machine and enter the initial state of refrigeration. The temperature area displays "L1", and the set temperature is displayed after 5s; Press "ECO" once when the device is on, the remote controller will display "L1", and 5S will display the setting temperature. The device will operate according to the power saving 20%. Press "ECO" button again when displaying "L1"; the remote controller displays "L2"; 5S shows the setting temperature; the device operates according to the power saving of 40%. Press "ECO" once again when L2 is displayed, "L3" is displayed on the remote controller, and the set temperature is displayed after 5S. At this time, the device operates according to 60% power saving.
Press "ECO" once again to exit "ECO" mode.
 3. To display the setting temperature, press "ECO" once to display the current gear.
 4. In the air supply mode, the "ECO" key is invalid. Press strong force, air supply and shutdown to exit the power of third gear.
 5. When "ECO" mode L3 is set, 60% power saving will affect the refrigeration/heating effect. It is suggested that users should set L2 or L1 according to the actual situation to give consideration to both comfort and energy-saving experience
- note: This function is available with Cooling Mode
Capacity may decrease when Energy Control mode is selected

(This function is unavailable on some models)

Operation

Comfortable SLEEP

Press **SLEEP** button, the remote controller will show , and then achieve to the sleep function.

Press again this **SLEEP** button, the sleep function will be cancelled

Operation Mode

1. In COOL/DRY mode

1 hours after SLEEP mode starts, temp. will become 1°C higher than temp. setting. After another 1 hours, temp. rises by 1°C further. The unit will run for further 6 hours then stops Making for a comfortable sleep.

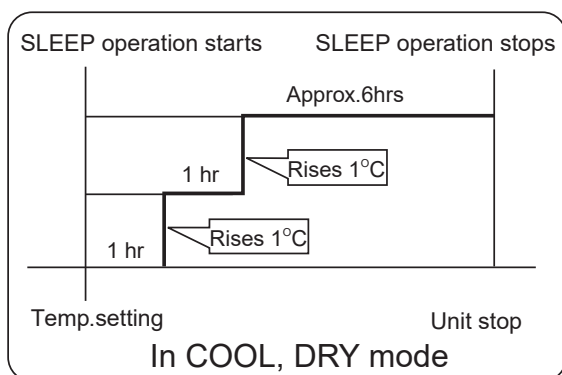

2. In HEAT mode

1 hours after SLEEP mode starts, temp will become 2°C lower than temp. setting. After another 1 hours, temp. decrease by 2°C further. After more another 3 hours, temp. rises by 2°C further. The unit will run for further 3 hours then stops Making for a comfortable sleep.

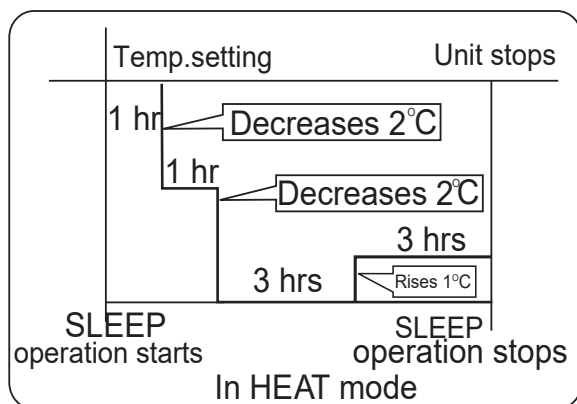

3. In AUTO mode

The unit operates in corresponding sleep mode corresponding sleep mode adapted to the automatically selected operation mode.

4. In FAN mode

It has no SLEEP function.

5. When quiet sleeping function is set to 8 hours, the quiet sleeping time cannot be adjusted.

Note:

When TIMER function is set, the quiet sleeping function can't be set up. After the sleeping function is set up, if user resets TIMER function, the sleeping function will be cancelled; the machine will be in the state of timing-on. If the two modes are set up at the same time, either of their operation time is ended first, the unit will stop automatically, and the other mode will be cancelled.

Note to the power failure resume:

Press the sleep button ten times in five seconds and enter function after hearing four sounds. And press the sleep button ten times within five seconds and leave this function after hearing two sounds.

Power Failure Resume Function:

If the unit is started for the first time, the compressor will not start running unless 3 minutes have elapsed. When the power resumes after power failure, the unit will run automatically, and 3 minutes later the compressor starts running.

Healthy airflow Operation

1. Press  to start

Setting the comfort work conditions.

2. The setting of healthy airflow function 

1) Press the button of health airflow,  appears on the display. Avoid the strong airflow blows direct to the body.

2) Press the button of health airflow again,  appears on the display. Avoid the strong airflow blows direct to the body.

3. The cancel of the healthy airflow function

Press the button of health airflow again, both the inlet and outlet grills of the air conditioner are opened, and the unit goes on working under the condition before the setting of airflow function. After stopping, the outlet grille will close automatically.

Note:

1. After setting the healthy airflow function, the position grill is fixed.

2. In cooling, it is better to select the  mode.

3. In cooling and dry, using the air conditioner for a long time under the high air humidity, condensate water may occur at the grille.

Operation

Self Clean Operation

1. Functional description:

The purpose of this function is to clean the evaporator.

2. Entry and exit

Press self clean button to enter this function, then it will display "CL" on the panel of the indoor unit and also on the remote controller. After running 20-30 minutes, this function will exit automatically when the " Pi " sound is heard twice then the unit returns to original state. Under operation process of self clean, pressing the button repeatedly has no effect and the function will not exit, but pressing the power off button and other mode button can make it exit.

NOTE:

- ◆ It has no effect under the mode of timer/sleep.
- ◆ After this mode starts, the air volume may reduce, or it may even have no airflow.
- ◆ It is normal if the unit makes some noise like expanding with heat and contracting with coldness.
- ◆ The "CL" display time may last differently on the remote controller and panel.
- ◆ It is normal if the temperature is below 0°C outside, and the unit may display "F25" under this mode running. Please turn off the unit for 10 seconds then restart.
- ◆ best condition to run this mode: the temperature is 15°C ~27°C and the humidity is 35%~60% in the door, the temperature is 30°C~40°C(cooling season) and below 10°C(heating season) out the door.
- ◆ It is hard to frost if the air is too dry(humidity <20%), and if the humidity is too high(humidity >70%), the condensate water may increase, which may move away some frost.
- ◆ Some models do not have this function.

LIGHT Button

Control the lightening and extinguishing of the indoor LED display board.

LOCK Button

Used to lock buttons and LCD display.

RESET Button

If the remote control is not functioning properly, press this button to reset the remote.

DRED Operation

Haier DRED enabled air-conditioners have a Demand Response Mode display on the indoor unit. The display could be labelled d1, d2, d3 (wording may differ model to model).

These modes are described in more detail below:

Mode	Display	Description	What to do
DRM3	d3	Your air-conditioner will continue to cool or heat during the peak demand event. The energy consumed by your air-conditioner is capped to 75%.	No action is required.
DRM2	d2	Your air-conditioner will continue to cool or heat during the peak demand event. The energy consumed by your air conditioner is capped to 50%.	No action is required.
DRM1	d1	Your air conditioner is still turned on and the fan will continue to operate. Your compressor is turned off and cool/hot air will no longer be generated.	DRM1 mode is only activated during emergency demand management situations. This mode will automatically reset the device within 2 hours. If your air-con is in this mode for longer than 2 hours please contact Energex on 13 12 53.

Maintenance

For Smart Use of The Air Conditioner

Setting of proper room temperature

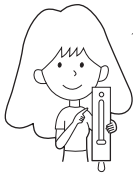

Proper temperature

Do not block the air inlet or outlet

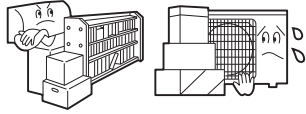

Close doors and windows during operation

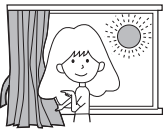

During cooling operation prevent the penetration of direct sunlight with curtain or blind

Use the timer effectively

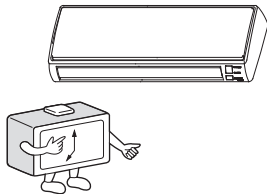

If the unit is not to be used for a long time, turn off the power supply main switch.



OFF

Use the louvers effectively



Remote Controller



Do not use water, wipe the controller with a dry cloth. Do not use glass cleaner or chemical cloth.

Indoor Body

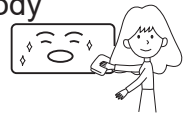

Wipe the air conditioner by using a soft and dry cloth. For serious stains, use a neutral detergent diluted with water. Wring the water out of the cloth before wiping, then wipe off the detergent completely.

Do not use the following for cleaning



Gasoline, benzene, thinner or cleanser may damage the coating of the unit.



Hot water over 40°C (104°F) may cause discoloring or deformation.

Air Filter cleaning

1 Open the inlet grille by pulling it upward.

2 Remove the filter.

Push up the filter's center tab slightly until it is released from the stopper, and remove the filter downward.

3 Clean the filter.

Use a vacuum cleaner to remove dust, or wash the filter with water. After washing, dry the filter completely in the shade.

4 Attach the filter.

Attach the filter correctly so that the "FRONT" indication is facing to the front. Make sure that the filter is completely fixed behind the stopper. If the right and left filters are not attached correctly, that may cause defects.

5 Close the inlet grille.

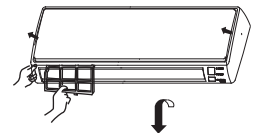

Once every two weeks

Replacement of Air Purifying Filter

(NOTE: Air purifying filter is optional part)

1. Open the Inlet Grille

Prop up the inlet grille by using a small device named grille-support which located in the right side of the indoor unit.

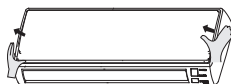

2. Detach the standard air filter

Slide the knob slightly upward to release the filter, then withdraw it.

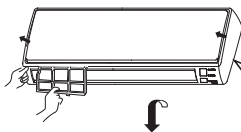

Detach old Air Purifying Filter



3. Attach Air Purifying Filter

Put air purifying filter appliances into the right and left filter frames.

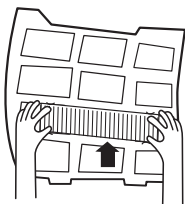

4. Attach the standard air filter

(Necessary installation)

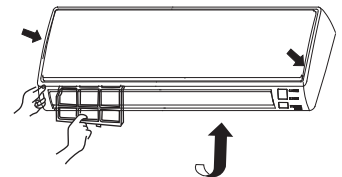

ATTENTION:

The white side of the photocatalyst air purifying filter face outside, and the black side face the unit.

The green side of the bacteria-killing medium air purifying filter face outside, and the white side face the unit.

5. Close the Inlet Grille

Close the Grille surely

NOTE:









- The photocatalyst air purifying filter will be solarized in fixed time. In normal family, it will be solarized every 6 months.
- The bacteria-killing medium air purifying filter will be used for a long time, no need for replacement. But in the period of using them, you should remove the dust frequently by using vacuum cleaner or flapping them lightly, otherwise, its performance will be affected.
- Please keep the bacteria-killing medium air purifying filter in the cool and dry conditions avoid long time directly sunshine when you stop using it, or its ability of sterilization will be reduced.

Cautions

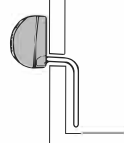

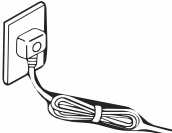
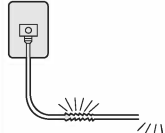
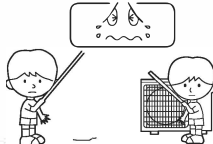
⚠ WARNING

Please call Sales/Service Shop for the Installation.
Do not attempt to install the air conditioner by yourself because improper works may cause electric shock, fire, water leakage.

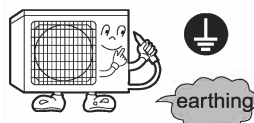
⚠ WARNING



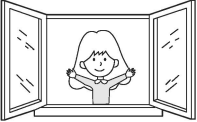
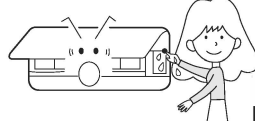
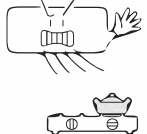
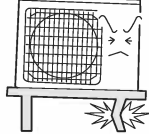
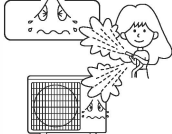

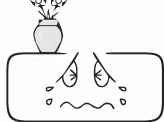
<p>When abnormality such as burnt-smell found, immediately stop the operation button and contact sales shop.</p>  <p>OFF</p> <p>STRICT ENFORCEMENT</p>	<p>Use an exclusive power source with a circuit breaker</p> 	<p>Check proper installation of the drainage securely</p>  <p>STRICT ENFORCEMENT</p>
<p>Connect power supply cord to the outlet completely</p>  <p>STRICT ENFORCEMENT</p>	<p>Use the proper voltage</p>  <p>STRICT ENFORCEMENT</p>	<p>1. Do not use power supply cord extended or connected in halfway 2. Do not install in the place where there is any possibility of inflammable gas leakage around the unit. 3. Do not get the unit exposed to vapor or oil steam.</p> <p>PROHIBITION</p>
<p>Do not use power supply cord in a bundle.</p>  <p>PROHIBITION</p>	<p>Take care not to damage the power supply cord.</p>  <p>PROHIBITION</p>	<p>Do not insert objects into the air inlet or outlet.</p>  <p>PROHIBITION</p>
<p>Do not start or stop the operation by disconnecting the power supply cord and so on.</p>  <p>PROHIBITION</p>	<p>Do not channel the air flow directly at people, especially at infants or the aged.</p>  <p>PROHIBITION</p>	<p>Do not try to repair or reconstruct by yourself.</p>  <p>Connect the earth cable.</p>  <p>earthing</p>

⚠ CAUTION

<p>Do not use for the purpose of storage of food, art work, precise equipment, breeding, or cultivation.</p>  <p>PROHIBITION</p>	<p>Take fresh air occasionally especially when gas appliance is running at the same time.</p>  <p>STRICT ENFORCEMENT</p>	<p>Do not operate the switch with wet hand.</p>  <p>PROHIBITION</p>
<p>Do not install the unit near a fireplace or other heating apparatus.</p>  <p>PROHIBITION</p>	<p>Check good condition of the installation stand</p>  <p>PROHIBITION</p>	<p>Do not pour water onto the unit for cleaning</p>  <p>PROHIBITION</p>
<p>Do not place animals or plants in the direct path of the air flow</p>  <p>PROHIBITION</p>	<p>Do not place any objects on or climb on the unit.</p>  <p>PROHIBITION</p>	<p>Do not place flower vase or water containers on the top of the unit.</p>  <p>PROHIBITION</p>

Trouble shooting

Before asking for service, check the following first.

	Phenomenon	Cause or check points
Normal Performance inspection	The system does not restart immediately. 	<ul style="list-style-type: none"> When unit is stopped, it won't restart immediately until 3 minutes have elapsed to protect the system. When the electric plug is pulled out and reinserted, the protection circuit will work for 3 minutes to protect the air conditioner.
	Noise is heard 	<ul style="list-style-type: none"> During unit operation or at stop, a swishing or gurgling noise may be heard. At first 2-3 minutes after unit start, this noise is more noticeable. (This noise is generated by refrigerant flowing in the system.) During unit operation, a cracking noise may be heard. This noise is generated by the casing expanding or shrinking because of temperature changes. Should there be a big noise from air flow in unit operation, air filter may be too dirty.
	Smells are generated.	<ul style="list-style-type: none"> This is because the system circulates smells from the interior air such as the smell of furniture, paint, cigarettes.
	Mist or steam are blown out. 	<ul style="list-style-type: none"> During COOL or DRY operation, indoor unit may blow out mist. This is due to the sudden cooling of indoor air.
	In dry mode, fan speed can't be changed.	<ul style="list-style-type: none"> In DRY mode, when room temperature becomes lower than temp. setting+2 °C, unit will run intermittently at LOW speed regardless of FAN setting.
Multiple check		<ul style="list-style-type: none"> Is power plug inserted? Is there a power failure? Is fuse blownout?
	Poor cooling 	<ul style="list-style-type: none"> Is the air filter dirty? Normally it should be cleaned every 15 days. Are there any obstacles before inlet and outlet? Is temperature set correctly? Are there some doors or windows left open? Is there any direct sunlight through the window during the cooling operation?(Use curtain) Are there too much heat sources or too many people in the room during cooling operation?

- Do not obstruct or cover the ventilation grille of the air conditioner. Do not put fingers or any other things into the inlet/outlet and swing louver.
- This appliance is not intended for use by persons (including children) with reduced physical, sensory or mental capabilities or lack of experience and knowledge, unless they have been given supervision or instruction concerning use of appliance by person responsible for their safety. Children should be supervised to ensure that they do not play with the appliance.

Specifications

- The refrigerating circuit is leak-proof.

The machine is adaptive in following situation

- Applicable ambient temperature range:

Cooling	Indoor	Maximum:D.B/W.B 32°C/23°C Minimum:D.B/W.B 21°C/15°C
	Outdoor	Maximum:D.B/W.B 46°C/26°C Minimum: D.B -10°C
Heating	Indoor	Maximum:D.B 27°C Minimum: D.B 15°C
	Outdoor	Maximum:D.B/W.B 24°C/18°C Minimum:D.B -10°C
	Outdoor (INVERTER)	Maximum:D.B/W.B 24°C/18°C Minimum:D.B -15°C

- If the power supply cord is damaged, it must be replaced by the manufacturer or its service agent or a similar qualified person.
- If the fuse of indoor unit on PC board is broken, please change it with the type of T. 3.15A/ 250V. If the fuse of outdoor unit is broken, change it with the type of T.25A/250V
- The wiring method should be in line with the local wiring standard.
- After installation, the power plug should be easily reached.
- The waste battery should be disposed properly.
- The appliance is not intended for use by young children or infirm persons without supervision.
- Young children should be supervised to ensure that they do not play with the appliance.
- Please employ the proper power plug, which fit into the power supply cord.
- The power plug and connecting cable must have acquired the local attestation.
- In order to protect the units, please turn off the A/C first, and at least 30 seconds later, cutting off the power.



For Haier Appliances

Australia 1300 729 948 | haier.com.au

New Zealand 0800 424 372 | haier.co.nz

Haier

Air Conditioning

Important notice of Disclosure: Copyright © Fisher & Paykel Appliances 2019. All rights reserved. The product dimensions and specifications in this document apply to the specific products and models described at the date of issue. Under our policy of continuous product improvement, these dimensions and specifications may change at any time. You should therefore check with your dealer or Haier's Customer Care Centre to ensure this flyer correctly describes the products currently available.

Fisher & Paykel Australia Pty Ltd, Level 1, 1 Eden Park Drive, Macquarie Park, NSW 2113.
Phone Customer Care: 1300 729 948 Email: customer.care@haier.com.au

Fisher & Paykel Appliances Ltd, 78 Springs Road, East Tamaki, Auckland 2013.
Phone Customer Care: 0800 424 372. Email: customer.care@haier.co.nz