

PRODUCT CATALOGUE 2021

About Us

Haneco is a private, 100% Australian owned and operated business.

Formed in 2011, we are celebrating 10 years of supplying quality LED products to the lighting industry, we now deliver over 2 million products a year. We have evolved to be a trusted leader in the design, manufacture, and distribution of LED lighting and smart control products.

Our priority today is to keep abreast of advances in light source, control drivers, connectivity technology and smart luminaire design. We have tailored our portfolio to offer a range of products designed to suit the varying requirements of our customers, enabling them to meet client briefs on opportunities to supply lighting solutions covering all project types, functional applications, aesthetic, budget, or scales. Featuring switchable wattage, colour temperature, automatic sunlight utilisation, adjustable auto-dimming, and emergency lighting capabilities, to name a few. Our complete LED product range is designed for residential, commercial, and industrial applications and can be relied upon by all.

At Haneco we understand that lighting is more than just illumination.

Our range of brands such as Lucesco and KASTA are designed to meet the evolving needs of wholesalers through to electrical contractors, from architects to interior designers.

Lucesco is devoted to providing customers with the technology through quality and illumination. Their range of products includes both interior and exterior solutions that are suited to architectural design and engineered driven projects. You will be inspired with our range that blends form and function – combining the aesthetic of contemporary European fixtures with robust engineering.

Haneco is the proud distributor of KASTA **Technologies smart products**, offering innovative, simple-to-install and simple-to-operate ecosystems of lighting and device controllers. Our range enables the full integration and control of all aspects of residential, office, hospitality or retail environments, such as lighting, security, access, climate systems and more. Whether you are building or renovating, **KASTA** can be easily incorporated to the conventional 240V wiring system, and offers seamless control of your space through a simple-to-use, intuitive app.

Haneco is dedicated to delivering the highest level of before and after-sales support, giving you a positive experience every time.

Our Lighting Designers, Product Engineers, Technical Support and Customer Service teams ensure that we can give you and your customer end-to-end service. So, whatever your project objectives or challenges, we can provide compliant solutions giving you the 100% confidence you need in our illumination performance and engineering design.

We pride ourselves on customer centricity.

100%

*Australian owned
and operated*

100%

*Service and distribution
coverage Australia wide*

100+

*Dedicated and experienced
lighting professionals*

10 years

*of success and continued
growth in the lighting
industry*





State-of-the-art research and development facilities.



Experienced in-house lighting design team.



We offer distribution centres and customer service Australia wide.



More than just the supply of luminaires.

Our Haneco team is knowledgeable and skilful with extensive industry experience that is supported with continuous training and development. Our team of Product Specialists and Engineers is available to provide specialised, product information and training to our valued customers to ensure the most suitable lighting design and luminaire for each project, all in accordance with the Australian Standards.

Nationwide Supply Chain and Distribution Network

With a national network of warehouses in Sydney, Melbourne, Perth, Brisbane and Adelaide we are able to cater to a diverse customer base. Our best practice EDI system means improved order tracking, accuracy and efficiency. Faster fulfillment means you can provide your customers a highly efficient service. Haneco is a provider of prompt, reliable product and service delivery across Australia's network of electrical industry.

We are your trusted partner for innovative products and reliable, professional customer service. With the latest innovations in LED lighting products and smart control systems, we help our customers deliver professionally connected illumination solutions across multiple sectors; residential development, multi-unit complex, hospitality, commercial and industrial.

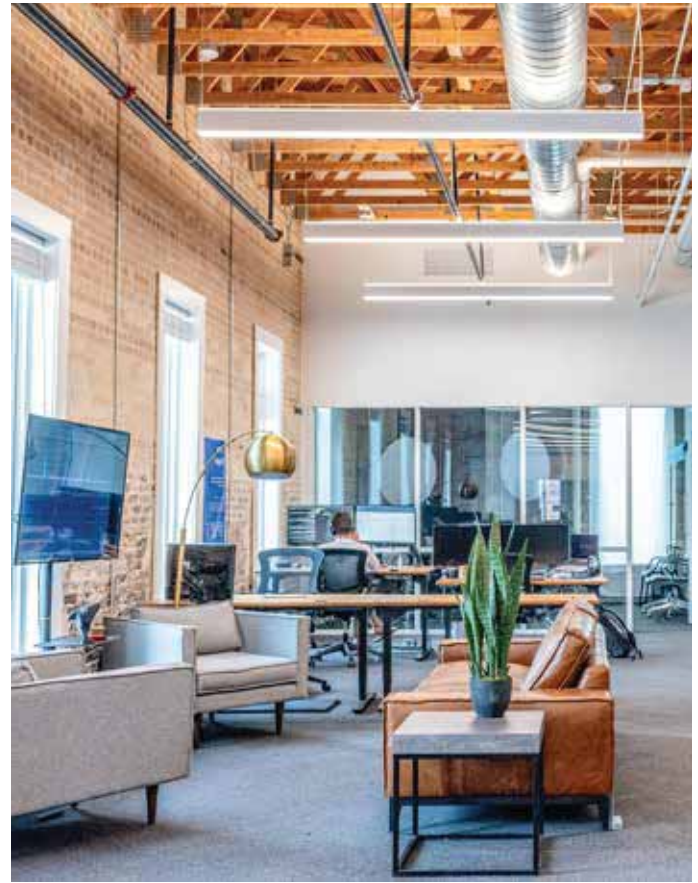

Lighting for Hospitality

The term **hospitality** covers many functional areas when applied to lighting.

Underpinning the term is a desire to make guests feel welcome, comfortable and equipped to do what they need whether it be to relax or be productive. Lighting plays a huge part in creating the ambience of a space as well as providing adequate illumination to perform tasks. It only takes a split second to make a good impression when a guest first enters a room!

The right light gives a hotel room a bright and friendly atmosphere. The wrong light can ruin a nicely decorated room. But there are many pragmatic decisions which may support a change in approach to your current lighting design.

As Part of a Cost Reduction Strategy

Energy-efficient LEDs combined with smart control technology may reduce energy usage by up to 80% thus offering substantial savings on usage costs.

New LED technology continues to lower energy consumption while improving product quality, eye comfort features, longevity and interactivity with lighting control systems.

The price of LED light sources has reduced dramatically to the point where many globes and fittings are comparable to units using older style light source technology.

Further reductions in energy usage can be achieved by implementing lighting design schemes in which natural or ambient light sources are considered and included in the design and control operation schedule of the lighting schema. "Daylight harvesting" as this design philosophy is known, also embraces the changes in ambient light that occur throughout the day that have been shown to affect mood and productivity via the circadian rhythms to which the human body and mind operate.

To Improve Operations

Smart controlled LED light sources can proactively improve operational outcomes namely via management tools such as building maintenance and facilities systems. These systems often provide control of multiple sites from a single central location with reporting of lamp failure detection, operating parameters, lighting schedules and other controls (such as HVAC systems) typical of these systems.

Centralised building maintenance systems also feature tools to assist facilities managers with achieving maximum savings due to remote control abilities.



Improve Guest Experiences

Members of the hospitality industry constantly look for ways to differentiate themselves against competitors within an increasingly competitive landscape. While the design of welcoming, inspiring spaces throughout a hotel facility can be a way to improve guest experiences, true brand differentiation can be achieved through helping guests create experiences unique to them. Light can be used to help a guest personalise their room to suit their mood, purpose of stay or enhance their productivity with effective task lighting in guest rooms, business centres or conference/meeting facilities.

Adding Safety While Lowering Costs

Up to 75% of the operations of a hotel or resort do not directly involve guests. Worker safety and productivity then become the priority for workplace illumination ensuring that the methods and design are both effective enough to achieve minimum safe illumination levels and to carry out work whilst also being flexible enough to change the lighting as the need arises.

Underground parking areas also often include laundry facilities, water towers, HVAC and other environmental system including dust, mist and fume controls. Lighting in parking areas can therefore be expensive, especially when used 24/7.

Wireless equipped lighting systems that detect the presence of people and vehicles provide solutions to saving energy and reducing operational expenditures. Adding long-life, low-maintenance LED lights enable you to create car park lighting solutions that can contribute to not only effective environmental management but also to keeping workers and visitors safe as well as adding conveniences such as car space availability, ticketless ingress/ egress.

Engage the Senses

Good lighting products coupled with effective lighting design can invigorate guests' senses beyond mere sight. Good lighting can make décor, food and furniture more appealing.

LED lights do not radiate high waves of UV and thus can contribute to keeping food fresh or stop fading of assets such as art pieces, window dressings or furniture.

Downlights

10

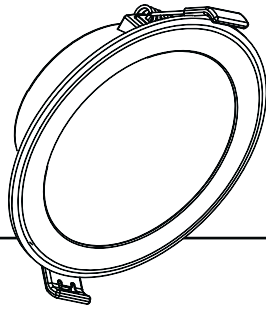

Surface Mount Lighting

76

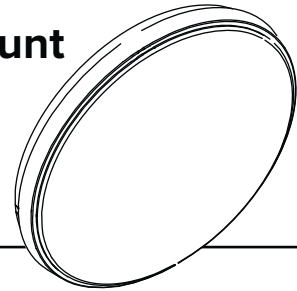

Linear Lighting

100

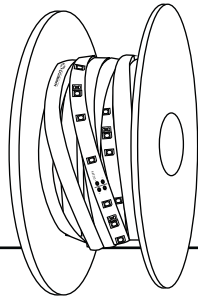

Batten Lighting

118

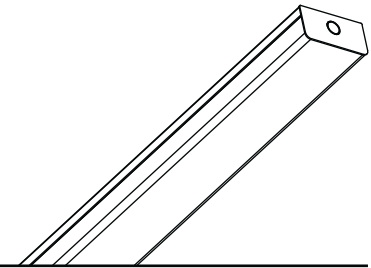

Industrial Lighting

174

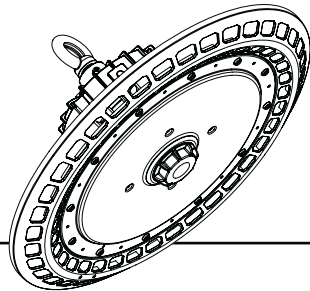

Exterior Lighting

210

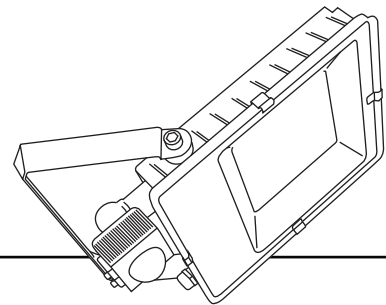

Retrofit Solutions

282

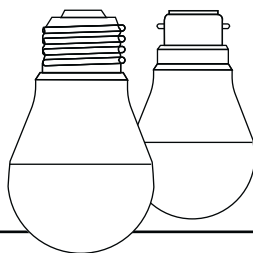

Intelligent Lighting

290

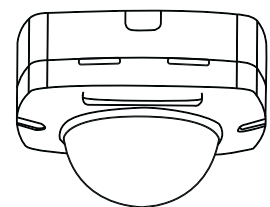

Spotlights

90

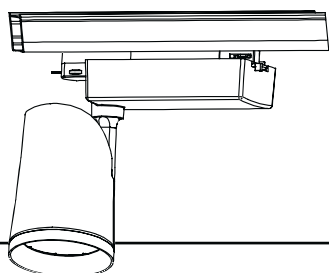

Panel Lighting

158

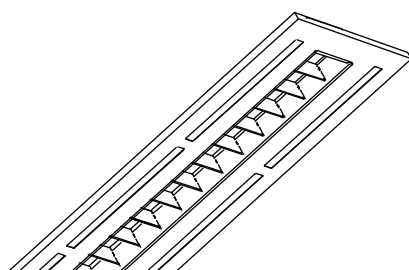

Emergency Lighting

244

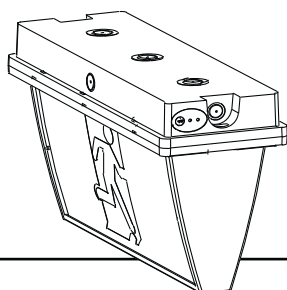

LED Drivers

328

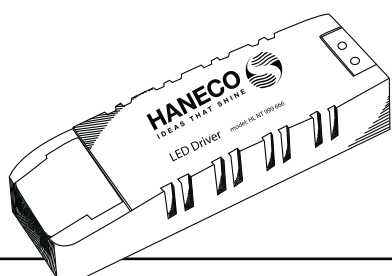

Content

Downlights

Residential	10
Commercial	42
Square	66

Surface Mount Lighting

Downlighting	76
Oyster range	82

Spotlights

Track Lights	90
--------------------	----

Linear Lighting

Continuous luminaires	100
-----------------------------	-----

Batten Lighting

Indoor	118
Outdoor	148

Panel Lighting

Panel range	158
-------------------	-----

Industrial Lighting

Highbay range	174
Lowbay range	204

Exterior Lighting

Flood lighting	210
Bollards	240

Emergency Lighting

Safety lighting	244
-----------------------	-----

Retrofit Solutions

Replacement light globes	282
--------------------------------	-----

Intelligent Lighting

Smart lighting control	290
------------------------------	-----

LED Drivers

Replacement lighting	328
----------------------------	-----

Residential

Downlights range

Whether recessed into a living room ceiling or used as a surface mounted feature in the kitchen or foyer, downlights possess the unique ability to transform a space. Effective downlighting can highlight areas of a room, to bring featured aspects alive or even divide the living space.



*Featured:
VIVA 115*





Viva Multi 90/110



STANDARDS



The VIVA MULTI 90/110 is a dimmable LED downlight with an opal diffuser. With Tritone colour selection it sits flush to the mounting surface and makes it perfect for any application where the light source is meant to be discrete. Complete with flex and plug, it is easy to install and ensures that the VIVA MULTI is a go-to fitting.

- Tritone selectable - 3000K, 4200K, 5700K
- Built-in dimmable driver
- IP44 ingress protection from below
- IC-4 covered & abutted with insulation
- Optional clip-on trim finishes to suit all décor (*Black and Nickel*)
- Complete with flex and plug for ease of installation

SPECIFICATIONS

VIVA MULTI 90/110

POWER	FEATURE	LUMEN	lm/W	CCT	WEIGHT	SAP CODE	PRODUCT CODE
7W	Tritone	550lm	79lm/W	3000K	0.18kg	2000690	VIVA90-MULTI
		620lm	89lm/W	4200K			
		600lm	86lm/W	5700K			
9W	Tritone	840lm	94lm/W	3000K	0.22kg	2000509	VIVA110-MULTI
		880lm	98lm/W	4200K			
		850lm	94lm/W	5700K			

VIVA MULTI 90/110 Accessories

ACCESSORIES	FEATURE	COMPATIBLE	SAP CODE	PRODUCT CODE
Clip-on Trim	Nickel	VIVA90-MULTI	2000894	TRN-VIVA90
	Black		2001058	TRB-VIVA90
	Nickel	VIVA110-MULTI	2000482	TRN-VIVA110
	Black		2000453	TRB-VIVA110
	Gold		2000454	TRG-VIVA110
Adaptor	Ø130mm (Cutout Ø110-120mm)		2000887	TRIM-VIVA110-130-W
	Ø170mm (Cutout Ø110-160mm)		2000663	TRIM-VIVA110-170-W

APPLICATIONS

- Residential
- Office
- Hospitality
- General applications

COLOUR AND VARIANTS



WHITE



VIVA
MULTI 90



VIVA
MULTI 110

OPTIONS



Clip-on Trim Black
TRB-VIVA90
TRB-VIVA110



Clip-on Trim Nickel
TRN-VIVA90
TRN-VIVA110



Clip-on Trim Gold
TRG-VIVA110

* Available for
VIVA110 only

LIGHT OPTICS



90°

90 degree beam spread with
precise circular beam output.

DIAGRAMS

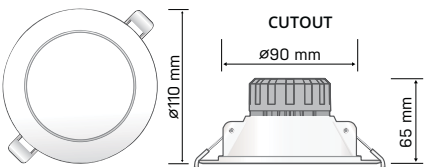

VIVA
MULTI 110

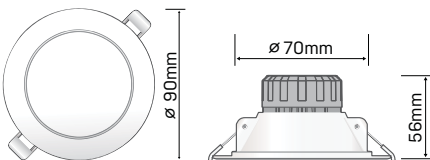

VIVA
MULTI 90



Viva 115



STANDARDS



The VIVA 115 is a LED downlight with an option of a flush or recessed opal diffuser. Tritone colour selection allows easy adjustment of output colour. VIVA's flush diffuser with clip-on trims provides a choice of finishes to fit a variety of looks.

- Tritone selectable - 3000K, 4200K, 5700K
- Built-in dimmable driver
- IC-4 covered & abutted with insulation
- Recessed diffuser minimises glare
- Flush version has optional clip-on trim finishes; Black, Brushed Nickel and Gold
- IP44 ingress protection from below
- Complete with flex and plug for ease of installation

SPECIFICATIONS

VIVA 115

POWER	FEATURE	LUMEN	lm/W	CCT	WEIGHT	SAP CODE	PRODUCT CODE
8W	Tritone	800 lm	100 lm/W	3000K	0.20 kg	2001847 2001846	VIVA-FL-TRI VIVA-RC-TRI
		850 lm	106 lm/W	4200K			
		800 lm	100 lm/W	5700K			

VIVA 115 accessories

ACCESSORIES	FEATURE	SAP CODE	PRODUCT CODE
Clip-on Trims for VIVA115 (only for FLUSH version)	BLACK	2001875	TRIM-VIVA-BLK
	GOLD	2001874	TRIM-VIVA-GLD
	NICKEL	2001876	TRIM-VIVA-NKL
Adaptor ring for both VIVA 115 models (also fits HABITAT)	130mm	2001877	TRIM-VIVA-130
	170mm	2001878	TRIM-VIVA-170

APPLICATIONS

- Residential
- Office
- Hospitality
- General applications

COLOUR AND VARIANTS



WHITE



RECESSED
VIVA-RC-TRI



FLUSH
VIVA-FL-TRI

OPTIONS



CLIP-ON Trim Black
TRIM-VIVA-BLK



CLIP-ON Trim Gold
TRIM-VIVA-GLD
(110 Model only)



CLIP-ON Trim Nickel
TRIM-VIVA-NKL



ADAPTOR Ring 130mm
TRIM-VIVA-130



ADAPTOR Ring 170mm
TRIM-VIVA-170

LIGHT OPTICS



Clean circular 100 degree beam output.

100°

DIAGRAMS

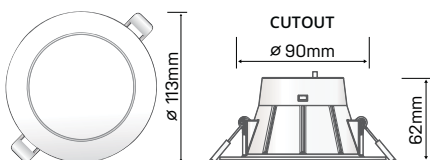

VIVA 115
FLUSH/RECESSED



Aurora 80

STANDARDS



The AURORA 80 is a compact, low glare LED downlight with a flush diffuser. IC-4 rating makes it safe with insulation and optional clip-on trims give you a choice of finishes.

- Available in 3000K or 5000K
- Low glare diffuser
- Universal dimming
- Remote dimmable driver
- Complete with flex and plug for ease of installation
- Also available in premium satin Nickel finish

SPECIFICATIONS

AURORA 80

POWER	LUMEN	lm/W	CCT	WEIGHT	SAP CODE	PRODUCT CODE
7W	540lm	77lm/W	3000K	0.39kg	2000046	AURORA80A01
	600lm	86lm/W	5000K		2000047	AURORA80A02

APPLICATIONS

- Residential
- Office
- Hospitality
- General applications

COLOUR AND VARIANTS



WHITE



NICKEL



LIGHT OPTICS



Wide 85 degree beam with diffused circular beam output.

85°

DRIVER

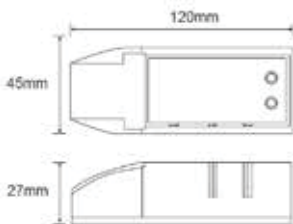

DIAGRAMS

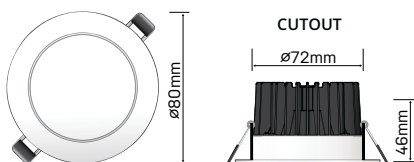

Aurora Tritone

STANDARDS



The AURORA TRITONE is a low-profile, dimmable downlight ideal for shallow ceiling spaces. Tritone colour selection allows easy adjustment of output colour. Clip-on trims gives a choice of finishes.

- Tritone selectable - 3000K, 4200K, 5700K
- Thin depth (37.5mm) for shallow ceiling spaces
- Remote driver
- Recessed diffuser with flicker free technology
- Diecast aluminium body for thermal management
- IP44 ingress protection from below
- Complete with flex and plug for ease of installation

SPECIFICATIONS

AURORA TRITONE

POWER	FEATURE	LUMEN	lm/W	CCT	WEIGHT	SAP CODE	PRODUCT CODE
10W	White	1050lm	90lm/W	3000K	0.20kg	2002051	AURORA10W110-W
		1010lm	100lm/W	4200K			
		970lm	95lm/W	5700K			
	Black	1050lm	90lm/W	3000K		2002052	AURORA10W110-B
		1010lm	100lm/W	4200K			
		970lm	95lm/W	5700K			
	Nickel	1050lm	90lm/W	3000K		2002053	AURORA10W110-N
		1010lm	100lm/W	4200K			
		970lm	95lm/W	5700K			

AURORA TRITONE accessories

ACCESSORIES	FEATURE	SAP CODE	PRODUCT CODE
Adaptor ring	130mm	2000455	TRIM-AURORAV2-130-W
	170mm	2000456	TRIM-AURORAV2-170-W

APPLICATIONS

- Residential
- Hotels
- Commercial interior
- Conference rooms
- Reception area
- Bathrooms

COLOUR AND VARIANTS



OPTIONS



LIGHT OPTICS

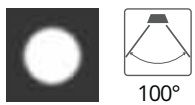

Clean circular 100 degree beam output.

DRIVER

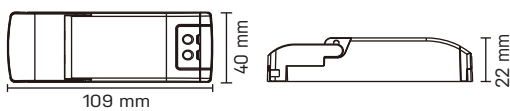

DIAGRAMS

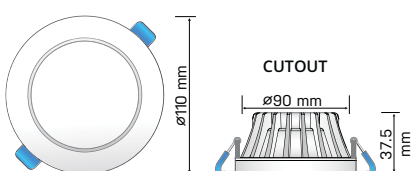

RESIDENTIAL DOWNLIGHT



Habitat



STANDARDS



The HABITAT is a slim, low profile downlight perfect for shallow ceilings and mezzanines. Tritone colour selection allows easy adjustment of output colour. The remote dimmable driver enables adjustment of brightness. A flush opal diffuser provides an even distribution of light. Supported by an IP54 rating the HABITAT is perfect for kitchens, bathrooms and laundries. Complete with a flex and plug, the HABITAT is also easy to install.

- Thin 35mm design for shallow ceiling spaces
- Tritone selectable - 3000K, 4200K, 5700K
- Remote dimmable driver
- IP54 ingress protection from below
- Complete with flex and plug for ease of installation

SPECIFICATIONS

HABITAT

POWER	FEATURE	LUMEN	lm/W	CCT	WEIGHT	SAP CODE	PRODUCT CODE
10W	White	1000 lm	100 lm/W	3000K	0.30kg	2002012	HABITAT-FL-TRI
		1050 lm	105 lm/W	4200K			
		1000 lm	100 lm/W	5700K			

HABITAT accessories

ACCESSORIES	FEATURE	SAP CODE	PRODUCT CODE
Adaptor ring	130mm	2001877	TRIM-VIVA-130
	170mm	2001878	TRIM-VIVA-170

APPLICATIONS

- Residential
- Commercial
- Conference rooms
- Bathrooms
- Wet areas

COLOUR AND VARIANTS



OPTIONS



ADAPTOR Ring 130mm
TRIM-VIVA-130



ADAPTOR Ring 170mm
TRIM-VIVA-170

LIGHT OPTICS



Clean circular 100 degree beam output.

100°

DRIVER

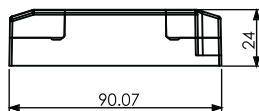

DIAGRAMS

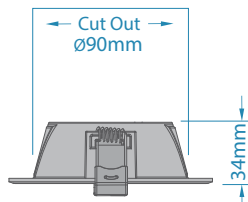
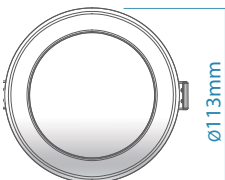



RESIDENTIAL DOWNLIGHT



Stellar 60



STANDARDS



The STELLAR 60 is a small adjustable downlight LED downlight with white trim. It has a 35 degree beam making it perfect for accent lighting of key features within the environment. It also comes in a range of colour temperatures to suit to a wide range of applications including residential downlighting, display cabinets in retail or hospitality applications.

- Low profile design to suit cabinet
- 3000K, 4000K or 6000K
- Adjustable 30° arc
- Superior optical control from faceted reflector
- Ideal for highlighting small niches and artwork
- Remote driver
- IP40 ingress protection

SPECIFICATIONS

STELLAR 60

POWER	LUMEN	lm/W	CCT	WEIGHT	SAP CODE	PRODUCT CODE
3W	250lm	83lm/W	3000K	0.25kg	2000440	STELLAR60A01
	220lm	73lm/W	4000K		2000442	STELLAR60A4K
	210lm	70lm/W	6000K		2000441	STELLAR60A02

APPLICATIONS

- Retail
- Hospitality
- Cabinets
- Accent Lighting

COLOUR AND VARIANTS



LIGHT OPTICS



35 degree circular beam adjustable to direct light to where desired, especially if using as a point of focus.

DRIVER

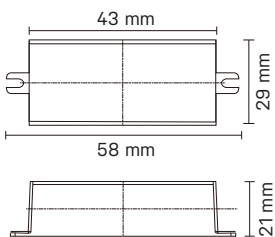

DIAGRAMS

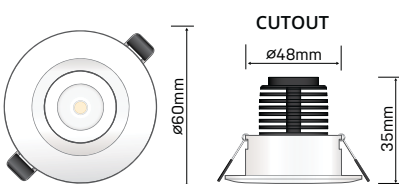



Retro 7W Kit

STANDARDS

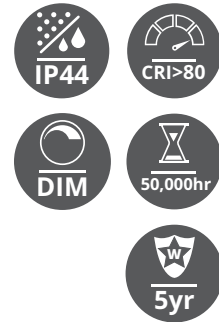

The RETRO 7W KIT is an energy efficient replacement LED Retrofit Lamp. Complete with a range of trim accessory options, remote driver and a flex and plug for ease of installation.

- Diecast aluminium alloy construction
- Multifaceted polycarbonate lens
- Choice of trim shape and colour; square or circular, white or silver
- Remote driver
- 40mm profile
- Excellent luminous efficacy
- Complete with flex and plug for ease of installation

SPECIFICATIONS

RETRO 7W KIT

POWER	LUMEN	lm/W	CCT	SAP CODE	PRODUCT CODE
7W	650lm	93lm/W	3000K	2000890	RETRO7WRF-3K
	730lm	104lm/W	5000K	2000747	RETRO7WRF-5K

RETRO 7W KIT accessories

ACCESSORIES	FEATURE	SAP CODE	PRODUCT CODE
Trim Ø108mm Outer diameter Ø90mm cut-out	Round White	2000261	HHG108B
	Round Chrome	2000260	HHG108A
Trim 100 x 100mm Outer dimension 90 x 90mm cutout	Square Silver	2000259	HHG100SQB

APPLICATIONS

- Residential
- Halogen globe replacement

OPTIONS

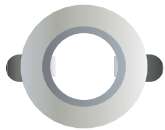

ROUND Chrome
TRIM-VIVA-BLK



ROUND White
TRIM-VIVA-GLD



SQUARE Silver
TRIM-VIVA-NKL

LIGHT OPTICS



60 degree beam spread with precise circular beam output.

DRIVER

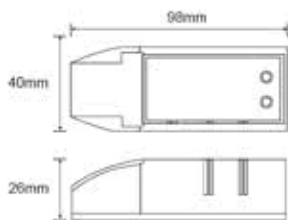

DIAGRAMS

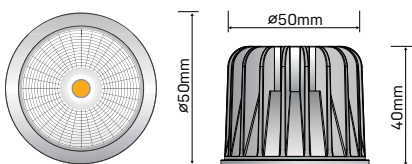

RESIDENTIAL DOWNLIGHT



Dular



STANDARDS



The DULAR offers an all-in-one solution. Featuring a built-in dimmable driver and recessed design it offers low glare output for eye comfort. The DULAR also uses Tritone colour select technology so you can achieve the exact colour of light output you desire. Available as trimless or with adjustable options.

- Available in fixed and adjustable versions
- Tritone selectable - 3000K, 4000K, 5700K
- Low glare, recessed design
- Complete with flex and plug for ease of installation
- Built-in dimmable driver
- IP44 ingress protection from below (*trimless version only*)
- Adjustable version features adjustable angle 0-30°

SPECIFICATIONS

DULAR trimless

POWER	FEATURE	LUMEN	lm/W	CCT	WEIGHT	SAP CODE	PRODUCT CODE
8W	Tritone	820 lm	102 lm/W	3000K	0.25 kg	2001850 2001892	DULAR-FIX-TRI DULAR-FIX-BLK
		930 lm	116 lm/W	4000K			
		880 lm	110 lm/W	5700K			

DULAR adjustable

POWER	FEATURE	LUMEN	lm/W	CCT	WEIGHT	SAP CODE	PRODUCT CODE
8W	Tritone	820 lm	102 lm/W	3000K	0.25 kg	2001856 2001893	DULAR-ADJ-TRI DULAR-ADJ-BLK
		930 lm	116 lm/W	4000K			
		880 lm	110 lm/W	5700K			

APPLICATIONS

- Residential
- Retail
- Showroom

COLOUR AND VARIANTS



WHITE



BLACK



TRIMLESS
DULAR-FIX-TRI

ADJUSTABLE
DULAR-ADJ-TRI



TRIMLESS
DULAR-FIX-BLK

ADJUSTABLE
DULAR-ADJ-BLK

LIGHT OPTICS



45°

45 degree beam spread with precise circular beam output.

DIAGRAMS

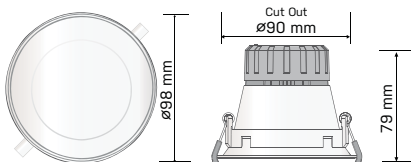

DULAR FIXED

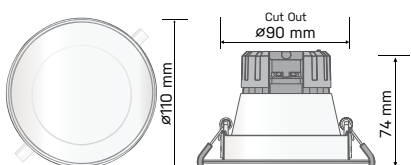

DULAR ADJUSTABLE





Detail



STANDARDS

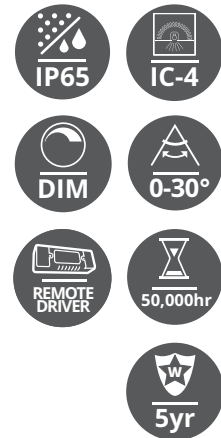

The DETAIL is a dimmable downlight that delivers a wide 60 degree beam and the adjustable 30 degree arc enables precision aiming. The optical lens is specifically engineered to reduce glare, the sealed ring housing offers protection against moisture and contaminant ingress giving it an IP65 rating. Suitable for high end bathrooms and outdoor spaces. Available in black or white bevelled trim and supplied with remote driver.

- IP65 ingress protection
- 3000K, 4000K or 5000K
- Adjustable LED downlight
- Highly engineered optical lens to reduce glare
- Robust diecast aluminium construction
- Remote driver
- Complete with flex and plug for ease of installation

SPECIFICATIONS

DETAIL

POWER	SAP CODE	LUMEN	lm/W	CCT	WEIGHT	SAP CODE	PRODUCT CODE
9W	White	990lm	110lm/W	3000K	0.40kg	2000159	D9W110R3KWIP65
	Black					2000584	D9W110R3KBKIP65
	White	1120lm	125lm/W	4000K		2000161	D9W110R4KWIP65
	Black					2000160	D9W110R4KBKIP65
	White	980lm	109lm/W	5000K		2000164	D9W110R5KWIP65
	Black					2000585	D9W110R5KBKIP65

APPLICATIONS

- Residential
- Bathrooms
- Hospitality
- Kitchens

COLOUR AND VARIANTS



WHITE



BLACK



3K: D9W110R3KWIP65
 4K: D9W110R4KWIP65
 5K: D9W110R5KWIP65

3K: D9W110R3KBKIP65
 4K: D9W110R4KBKIP65
 5K: D9W110R5KBKIP65

LIGHT OPTICS

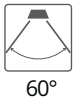

60°

60 degree circular beam adjustable to direct light to where desired, especially if using as a point of focus.

DRIVER

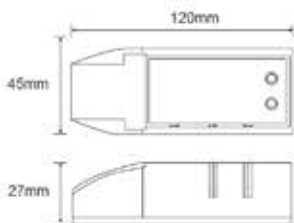

DIAGRAMS

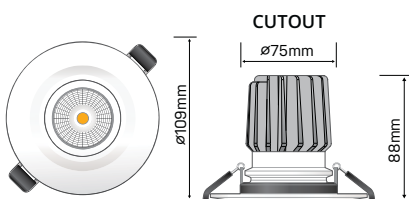

Dione



STANDARDS



The DIONE is a high output adjustable downlight with wide faceted reflector to provide uniform light distribution. The adjustable beam can be diverted to focus on specific areas are required, making the DIONE suitable for many commercial and retail applications

- Wide faceted reflector for uniform light distribution
- Highly engineered optical lens to reduce glare
- Slim trim design appears flush with ceiling
- Classic matte white or stylish silver finish
- Complete with flex and plug for ease of installation
- Remote driver

SPECIFICATIONS

DIONE

POWER	FEATURE	LUMEN	lm/W	CCT	WEIGHT	SAP CODE	PRODUCT CODE
15W	White	1190lm	80lm/W	3000K	0.90kg	2000145	D15W109R3KW
	Silver					2000144	D15W109R3KS

APPLICATIONS

- Residential
- Retail
- Hospitality

COLOUR AND VARIANTS



WHITE



SILVER



D15W109R3KW



D15W109R3KS

LIGHT OPTICS



45°

45 degree beam spread with precision circular beam output.

DRIVER

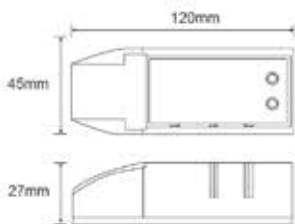

DIAGRAMS

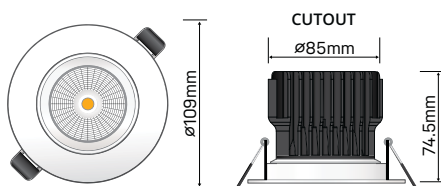

Artura



STANDARDS



The ARTURA series is a range of warm, aluminium body downlights featuring a deep recessed design for a narrow beam angle to create ambient spaces. It is also available with a 25mm pinhole diffuser to funnel the beam even further. ARTURA is an ideal luminaire to add atmosphere to any apartment and hospitality project.

- Extra low glare provided by deep recessed lens
- Modern, clean aesthetic appearance
- Black powder coated diecast aluminium body
- Narrow 24° beam angle to all directions
- Complete with flex and plug for ease of installation
- Phase-cut dimmable driver

SPECIFICATIONS

ARTURA

POWER	FEATURE	LUMEN	lm/W	CCT	WEIGHT	SAP CODE	PRODUCT CODE
4W	Recessed	275lm	100lm/W	2700K	0.22kg	2002155	ARTURA4W
	Pin Hole				0.23kg	2002156	ARTURA4W-PIN

APPLICATIONS

- Living rooms
- Hotels
- Meeting rooms
- Hallways

COLOUR AND VARIANTS



ARTURA4W



ARTURA4W-PIN

LIGHT OPTICS



24 degree beam spread with precise circular beam output.

24°

DRIVER

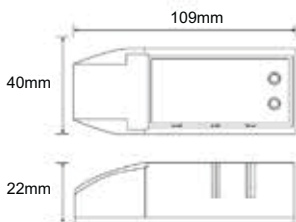

DIAGRAMS

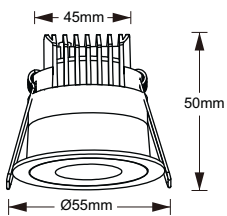

Trim



STANDARDS



The TRIM series is a range of aluminium body downlights featuring low glare, a narrow beam angle and an ultra-slim trim. It comes in three types – single head fixed, single head wall washer and double head adjustable. TRIM adds great value to apartment and hospitality projects.

- Extra low glare provided by deep recessed lens
- Modern, clean aesthetic appearance
- White powder coated diecast aluminium body
- 0-20° gimble to all directions for adjustable model
- IC-4 rating (*single and wall washer only*)
- Complete with flex and plug for ease of installation
- Phase-cut dimmable driver

SPECIFICATIONS

TRIM

POWER	FEATURE	LUMEN	lm/W	CCT	WEIGHT	SAP CODE	PRODUCT CODE
22W (2 x 11W)	Double	1790lm	81lm/W	3000K	0.55kg	2002044	TRIM22W3K50D
	Single Wall Washer	930lm	85lm/W	3000K	0.27kg	2002043	TRIM11W3K50DWW
11W	Single	980lm	89lm/W	3000K	0.24kg	2002041	TRIM11W3K50D
		1050lm	95lm/W	4000K	0.24kg	2002042	TRIM11W4K50D

APPLICATIONS

- Living rooms
- Hotels
- Meeting rooms
- Hallways

COLOUR AND VARIANTS



SINGLE
TRIM11W3K50D
TRIM11W4K50D



WALL WASHER
TRIM11W3K50DWW



DOUBLE
TRIM22W3K50D

LIGHT OPTICS



50 degree beam spread with precise circular beam output.

DRIVER



DIAGRAMS

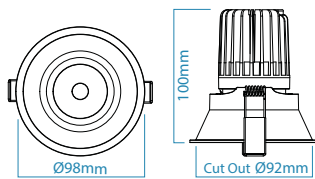

TRIM SINGLE

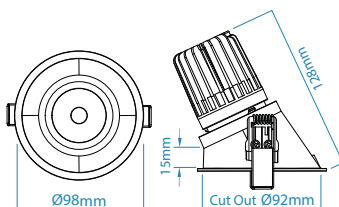

TRIM SINGLE
WALL WASHER

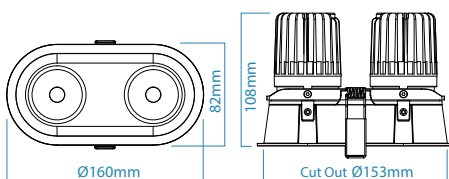

TRIM DOUBLE



Commercial

Downlights range

With a wide range of LED downlights, finding the right light is simple. Capable of producing warm, welcoming ambience to cool, functional areas, downlighting is one of the most attractive, subtle and effective ways to create the perfect environment.



*Featured:
STELLAR adjustable*



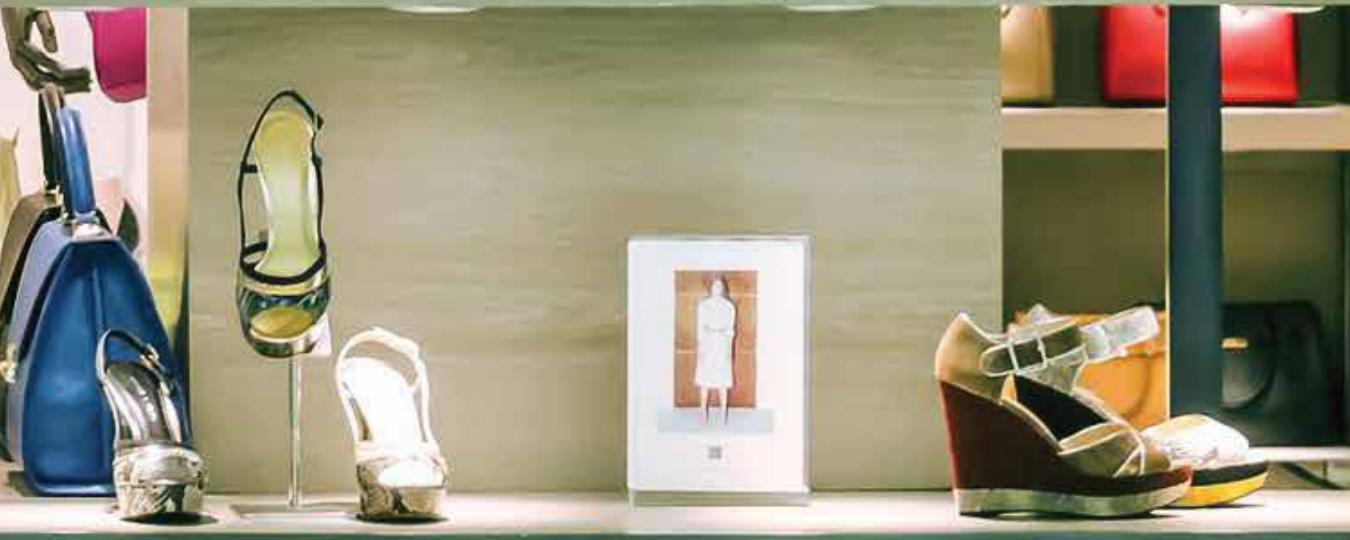

Viva 145



STANDARDS



The VIVA 145 is ideal for retrofits of larger conventional downlights where there is a larger hole to cover. Perfect for jobs where there is a large existing cutout (125mm), it allows installation without the need of adaptor plates.

- Tritone selectable - 3000K, 4200K, 5700K
- IP44 ingress protection (*front face only*)
- High output dimmable LED downlight
- 125mm cutout, perfect for retrofits
- Complete with flex and plug for ease of installation
- Built-in dimmable driver

SPECIFICATIONS

VIVA 145

POWER	FEATURE	LUMEN	lm/W	CCT	WEIGHT	SAP CODE	PRODUCT CODE
14W	Tritone	1240lm	89lm/W	3000K	0.29kg	2001103	VIVA145-TRI
		1260lm	90lm/W	4200K			
		1160lm	83lm/W	5700K			

APPLICATIONS

- Offices
- Hospitality
- General applications

COLOUR AND VARIANTS



LIGHT OPTICS



90 degree beam spread with precise circular beam output.

DIAGRAMS

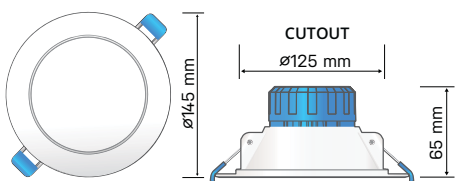

COMMERCIAL DOWNLIGHT



Helix



STANDARDS



The HELIX series is a versatile aluminium low-profile high output downlight with Tritone selectable, flicker-free technology and dual power intensity with IP54 rating. It comes in three sizes - 195mm, 225mm and 275mm.

- IP54 ingress protection from below (*front face only*)
- IC-4 rating (*15/20W model only*)
- Tritone selectable - 3000K, 4000K, 5700K
- Remote flicker-free driver
- Complete with flex and plug for ease of installation
- Diecast aluminium construction
- 195mm - 15/20W, 225mm - 23/30W, 275mm - 28/40W
- Low profile body (66mm) with recessed diffuser

SPECIFICATIONS

HELIX

POWER	FEATURE	LUMEN	lm/W	CCT	WEIGHT	SAP CODE	PRODUCT CODE
15/20W		1380 / 2060lm	98 / 103	3000K	0.90kg	2002045	HELIX20W195R
		1550 / 2310lm	111 / 116	4000K			
		1530 / 2270lm	109 / 113	5700K			
23/32W	Selectable Output Tritone	2240 / 3050lm	97 / 95	3000K	1.12kg	2002046	HELIX30W225R
		2480 / 3410lm	108 / 107	4000K			
		2360 / 3240lm	103 / 101	5700K			
28/40W		2810 / 4000lm	100 / 100	3000K	1.45kg	2002047	HELIX40W275R
		3170 / 4420lm	113 / 111	4000K			
		3100 / 4320lm	111 / 108	5700K			

APPLICATIONS

- Retail
- Industrial
- Commercial
- Galleries

ACCESSORIES

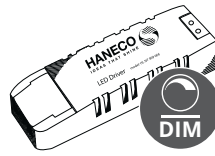

HANECO
DIMMABLE DRIVER
(See page 330)

COLOUR AND VARIANTS



WHITE



20W
HELIX20W195R

30W
HELIX30W225R

40W
HELIX40W275R

LIGHT OPTICS



100°

Clean circular 100 degree
beam output.

DIAGRAMS

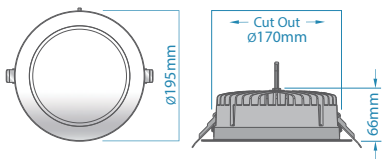

HELIX 20W

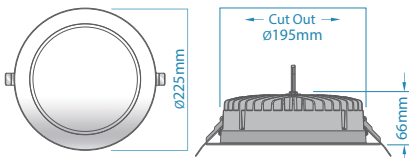

HELIX 30W

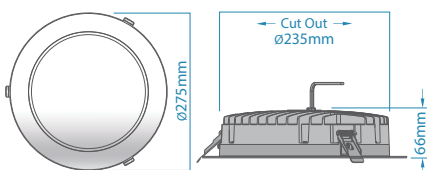

HELIX 40W

DRIVER

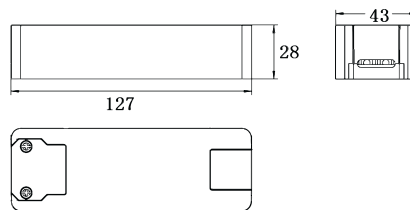
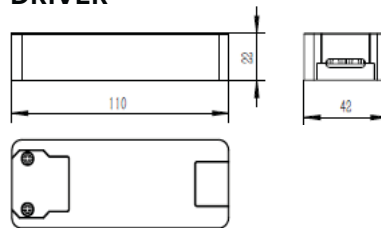

HELIX 30W

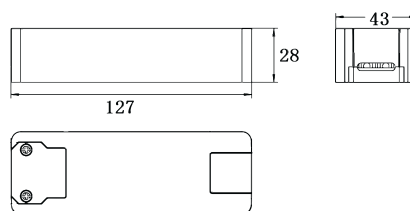

HELIX 40W



20W
HELIX20W195R

LOW CEILING



30W
HELIX30W225R

MEDIUM CEILING



COMMERCIAL DOWNLIGHT



40W
HELIX40W275R

HIGH CEILING

Centauri



STANDARDS



The CENTAURI is a versatile downlight that allows you to alter both colour temperatures and intensity for retail and display applications. This dual intensity luminaire with excellent colour rendering at CRI >83 comes in large (230mm), medium (190mm) and small (150mm) variants.

- Tritone selectable - 3000K, 4000K, 5000K
- Dual intensity selection - 20/30W, 10/15W & 15/25W
- Slightly recessed polycarbonate diffuser
- Extra-large face trim covers a range of cut-outs
- Diecast aluminium construction
- Low profile with remote driver
- Complete with flex and plug for ease of installation

SPECIFICATIONS

CENTAURI

POWER	FEATURE	LUMEN	lm/W	CCT	WEIGHT	SAP CODE	PRODUCT CODE
10W	Selectable output Tritone	1010lm	101lm/W	3000K 4000K 5000K	0.75kg	2001195	C10/15W150R-MULTI
		1090lm	109lm/W				
		1090lm	109lm/W				
15W	Selectable output Tritone	1440lm	96lm/W	3000K 4000K 5000K	0.96kg	2001087	C15/25W190R-MULTI
		1520lm	101lm/W				
		1490lm	99lm/W				
15W	Selectable output Tritone	1470lm	98lm/W	3000K 4000K 5000K	0.96kg	2001087	C15/25W190R-MULTI
		1600lm	107lm/W				
		1610lm	107lm/W				
25W	Selectable output Tritone	2500lm	100lm/W	3000K 4000K 5000K	1.20kg	2000576	C20/30W230R-MULTI
		2680lm	107lm/W				
		2640lm	106lm/W				
20W	Selectable output Tritone	2090lm	105lm/W	3000K 4000K 5000K	1.20kg	2000576	C20/30W230R-MULTI
		2250lm	113lm/W				
		2220lm	111lm/W				
30W	Selectable output Tritone	3040lm	101lm/W	3000K 4000K 5000K	1.20kg	2000576	C20/30W230R-MULTI
		3130lm	104lm/W				
		3050lm	102lm/W				

APPLICATIONS

- Retail
- Hospitality
- Commercial

COLOUR AND VARIANTS



C10/15W150R
-MULTI

C15/25W190R-
MULTI

C20/30W230R
-MULTI

OPTIONS



ADAPTOR RING 280mm
TRIM-C2030-280-W

* Suits 20W / 30W only

LIGHT OPTICS

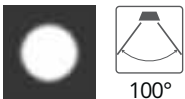

Clean circular 100 degree
beam output.

DIAGRAMS

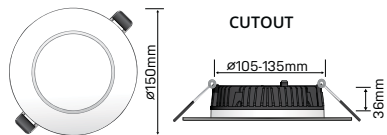

CUTOUT

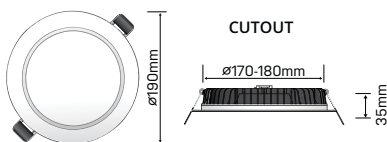
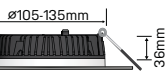

CUTOUT

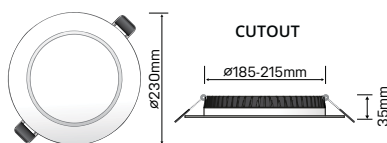
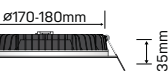

CUTOUT

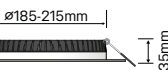

DRIVER

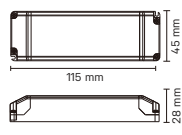

CENTAURI 10/15W

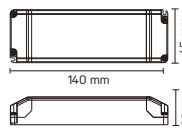

CENTAURI 15/25W

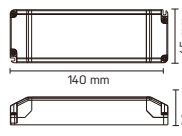

CENTAURI 20/30W





Astro



STANDARDS



The ASTRO is a series of anti-glare remote driver downlights, with the diffuser recessed deep into the body. The aluminium, silver look reflector also contributes to minimise glare with maximum visual comfort, creating an added luxury for most commercial service applications and high-end apartment interior spaces.

- Tritone selectable - 3000K, 4000K, 5700K
- Recessed LED fixed light weight downlight
- Low glare UGR<19 | CRI>82
- Constant current non-dimmable LED driver
- IP54 ingress protection from below (*front face only*)
- Two switchable output models:
 15/25W - 195mm trim with 170mm cut-out
 24/32W - 230mm trim with 210mm cut-out

SPECIFICATIONS

ASTRO

POWER	LUMEN	lm/W	CCT	WEIGHT	SAP CODE	PRODUCT CODE
15/25W	1400 / 2200lm	93 / 88	3000K	0.66kg	2001946	ASTRO25W195R
	1550 / 2400lm	103 / 96	4000K			
	1500 / 2300lm	100 / 92	5700K			
24/32W	2100 / 2850lm	88 / 89	3000K	0.83kg	2001947	ASTRO30W230R
	2300 / 3100lm	96 / 97	4000K			
	2200 / 3000lm	92 / 94	5700K			
24/32W	2100 / 2850lm	88 / 89	3000K	1.90kg	2002008	ASTRO30W-SM
	2300 / 3100lm	96 / 97	4000K			
	2200 / 3000lm	92 / 94	5700K			

APPLICATIONS

- Commercial
- Hotels
- Shops
- Conference rooms
- Office receptions
- Function areas

COLOUR AND VARIANTS



WHITE



25W
ASTRO25W195R



30W
ASTRO30W230R



SURFACE MOUNT
ASTRO30W-SM

LIGHT OPTICS



55°

55 degree beam spread with precise circular beam output.

DRIVER

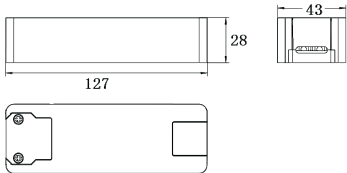

DIAGRAMS

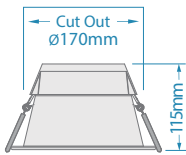
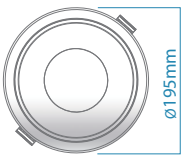

ASTRO 25W

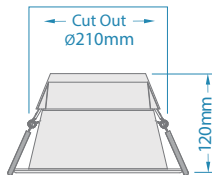
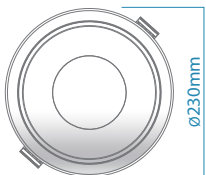

ASTRO 30W

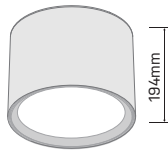
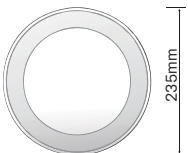

SURFACE MOUNT





Mars



STANDARDS



The MARS is a range of powerful downlights with a multifaceted reflector and clear lens, which has excellent optical control along with visual interest. An energy efficient alternative to high output metal halide downlights.

- Available in 20W/160mm, 30W/190mm, 40W/215mm
- Multi-faceted specular reflector to control glare
- Great alternative to halogen and metal halide
- Smart design with optimal thermal management
- Low profile
- Dimmable remote driver
- Complete with flex and plug for ease of installation

SPECIFICATIONS

MARS

POWER	LUMEN	lm/W	CCT	WEIGHT	SAP CODE	PRODUCT CODE
20W	1420lm	71lm/W	4000K	1.00kg	2000336	MARS20W160R4K
30W	2520lm	84lm/W	4000K	1.20kg	2000338	MARS30W190R4K
40W	3470lm	86lm/W	4000K	1.32kg	2000340	MARS40W215R4K

APPLICATIONS

- Retail
- Hospitality
- Commercial

COLOUR AND VARIANTS



LIGHT OPTICS

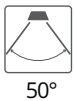

50 degree beam spread with precise circular beam output.

DIAGRAMS

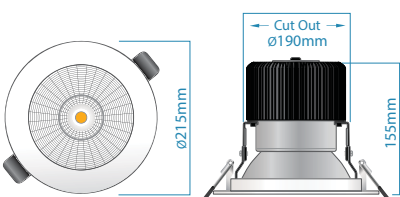
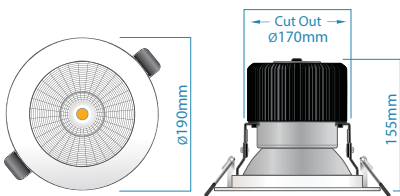
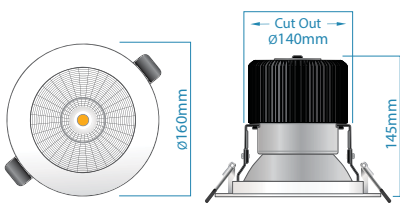

DRIVER

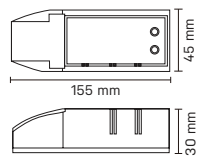

MARS 20W

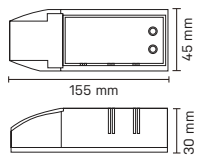

MARS 30W

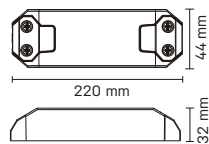

MARS 40W



Ovolo



STANDARDS



The OVOLO series is a large classically styled downlights featuring Tritone colour select, dual power intensity and weather resistant IP64 housing.

- Tritone selectable - 3000K, 4000K, 5700K
- Low profile lightweight polycarbonate body – 70mm
- High efficiency 100lm/W
- Power switchable with flicker-free technology
- Low glare design with slightly recessed diffuser
- Four models: 14W (145mm) / 18W (165mm) / 20W (200mm) / 30W (230mm)
- Complete with flex and plug for ease of installation

SPECIFICATIONS

OVOLO

POWER	LUMEN	lm/W	CCT	WEIGHT	SAP CODE	PRODUCT CODE
10W 14W	1000lm 1400lm	100lm/W	3000K 4000K 5700K	0.33kg	2002113	OVL14W145R
13W 18W	1300lm 1800lm			0.37kg	2002114	OVL18W165R
15W 20W	1500lm 2000lm			0.42kg	2002115	OVL20W200R
23W 30W	2300lm 3000lm			0.56kg	2002116	OVL30W230R

APPLICATIONS

- Retail
- Industrial
- Commercial

ACCESSORIES



HANECO
DIMMABLE DRIVER
(See page 330)

COLOUR



LIGHT OPTICS

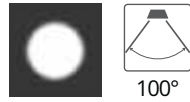

100 degree beam spread with precise circular beam output.

DIAGRAMS

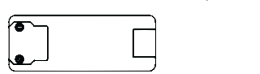
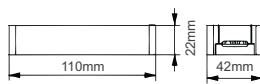
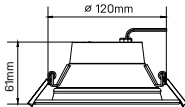
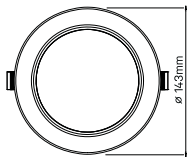

OVOLO 14W

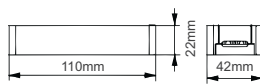
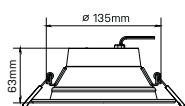
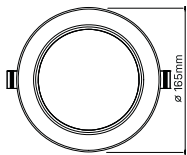

OVOLO 18W

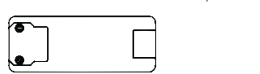
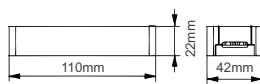
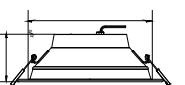
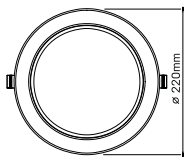

OVOLO 20W

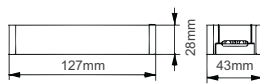
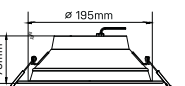
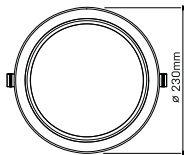

OVOLO 30W



Stellar



STANDARDS

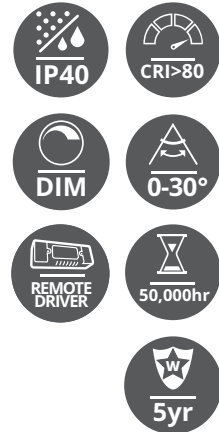

The STELLAR range is an energy efficient alternative to metal halide adjustable downlights with high output. It comes with multifaceted reflector for glare control and aesthetically pleasing design. Available in a range of wattages to suit various needs for strong lighting.

- Clear lens and deep multi-faceted reflector
- High output energy efficient spotlight
- Robust diecast aluminium construction
- Available in 15W, 20W, 30W and 40W
- Remote driver
- Complete with flex and plug for ease of installation

SPECIFICATIONS

STELLAR

POWER	FEATURE	LUMEN	lm/W	CCT	WEIGHT	SAP CODE	PRODUCT CODE
15W	Adjustable	1230lm	82lm/W	4000K	1.00kg	2000434	STELLAR120A4K
20W		1970lm	98lm/W		1.00kg	2000436	STELLAR145A4K
30W		2860lm	95lm/W		1.20kg	2000438	STELLAR170A4K
40W		3450lm	86lm/W		1.40kg	2000439	STELLAR190A4K

APPLICATIONS

- Retail
- Hospitality
- Commercial
- Hospitals

COLOUR AND VARIANTS



WHITE



LIGHT OPTICS



50 degree beam spread with precise circular beam output.

DIAGRAMS

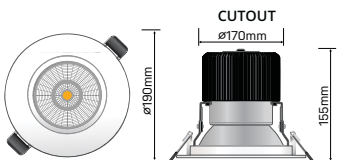
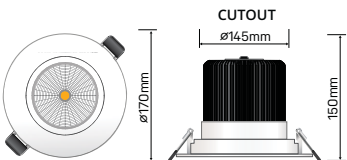
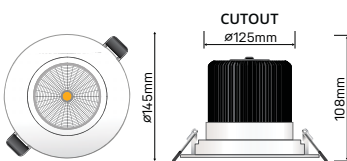
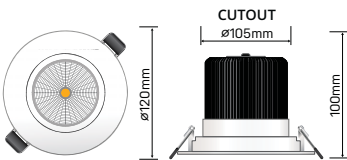

DRIVER

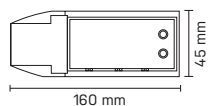

STELLAR 15W

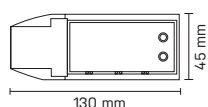

STELLAR 20W

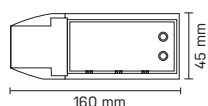

STELLAR 30W

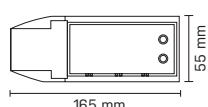

STELLAR 40W



Cedar Snorkel



STANDARDS



The CEDAR SNORKEL is a LED shoplight with multifaceted reflector for glare control. Both powerful and economical, this shoplight gives a useful angled beam to highlight specific areas. It is an ideal alternative to metal halide shoplights for retail applications.

- IP40 ingress protection (*front face only*)
- 0-90° Adjustable angle
- High output energy efficient shoplight
- Multi faceted reflector to control glare
- Remote driver
- Complete with flex and plug for ease of installation

SPECIFICATIONS

CEDAR SNORKEL

POWER	FEATURE	LUMEN	lm/W	CCT	WEIGHT	SAP CODE	PRODUCT CODE
38W	Adjustable	3050lm	80lm/W	4000K	1.50kg	2000151	D38W195R4K60DF

APPLICATIONS

- Retail
- Hospitality
- Commercial

COLOUR AND VARIANTS



LIGHT OPTICS

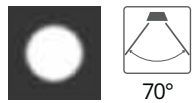

70 degree beam spread with precise circular beam output.

DRIVER

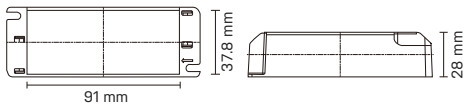

DIAGRAMS

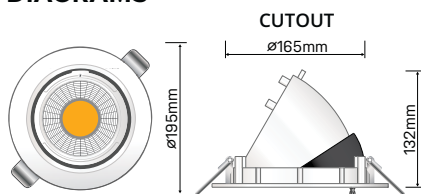

Cedar



STANDARDS



The CEDAR is a powerful rectangular LED shoplight that provides even light distribution. It is adjustable and an ideal alternative to metal halide shoplights. It suits retail applications.

- Traditional design with a white trim
- Recessed adjustable LED shoplight
- Excellent luminous efficacy
- Even light distribution
- Remote driver
- Complete with flex and plug for ease of installation

SPECIFICATIONS

CEDAR

POWER	LUMEN	lm/W	CCT	WEIGHT	SAP CODE	PRODUCT CODE
40W	4160lm	104lm/W	4000K	1.50kg	2000534	D40W242*150RE4K90DF
	4100lm	103lm/W	5000K		2000536	D40W242*150RE5K90DF

APPLICATIONS

- Retail
- Hospitality
- Commercial
- Large lobbies

COLOUR AND VARIANTS



LIGHT OPTICS

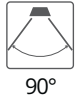

90 degree beam spread with precise circular beam output.

DRIVER

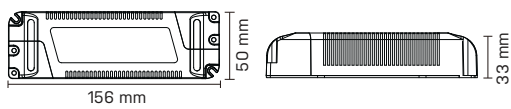

DIAGRAMS

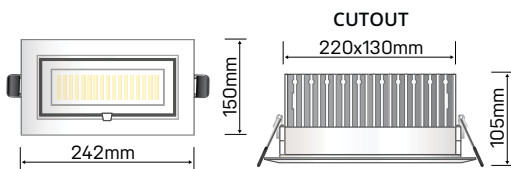

Square Downlights range

The primary purpose of a downlight is to provide functional ambient light. Square downlights perfectly suit commercial installations such as cafes, restaurants, retail shops and other projects.



*Featured:
XBOX double*



Ivo Nikkol



SQUARE DOWNLIGHT



Xbox



STANDARDS



The XBOX groups one to three LED downlights in square or rectangular frames. The lights are four-way adjustable for maximum flexibility and can be pointed in almost any direction.

- Single – 10W & 15W, Double – 20W & 30W, Triple – 30W
- Each lamp is individually four-way adjustable
- XBOX available in square or rectangular frames
- Powder coated aluminium decorative trim
- Multifaceted reflector with clear lens
- Complete with flex and plug for ease of installation

SPECIFICATIONS

XBOX

POWER	FEATURE	LUMEN	lm/W	CCT	WEIGHT	SAP CODE	PRODUCT CODE
10W	Single module	820lm	82lm/W	3000K	0.60kg	2000520	D10W112*112RE3KW
20W	Double module	1620lm	81lm/W	3000K	1.10kg	2000527	D20W200*112RE3KW
30W	Triple module	2230lm	74lm/W	3000K	1.28kg	2000529	D30W280*112RE3KW

APPLICATIONS

- Retail
- Cafes
- Restaurants
- Hotels

COLOUR AND VARIANTS



WHITE



SINGLE
MODULE



TWIN
MODULE



TRIPLE
MODULE

LIGHT OPTICS



45°

45 degree beam spread with precise circular beam output.

DRIVER

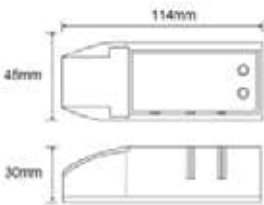

10 / 15W DRIVER

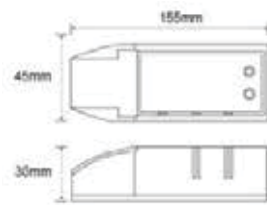

20 / 30W DRIVER

DIAGRAMS

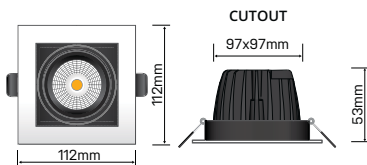

XBOX 10W SINGLE

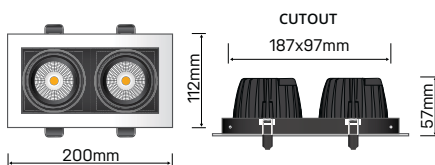

XBOX 20W TWIN

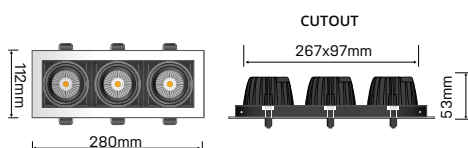

XBOX 30W TRIPLE





Xbox with Box

STANDARDS



The XBOX with Box features a box that makes the fitting fully sealed and dust resistant. The lights are four-way adjustable for maximum flexibility.

- Single – 10W & 15W, Double – 20W & 30W, Triple – 30W
- Each lamp is individually four-way adjustable
- XBOX available in square or rectangular frames
- Powder coated aluminium decorative trim
- Multifaceted reflector with clear lens
- Complete with flex and plug for ease of installation

SPECIFICATIONS

XBOX WITH BOX

POWER	FEATURE	LUMEN	lm/W	CCT	WEIGHT	SAP CODE	PRODUCT CODE
15W	Single module	1170lm	78lm/W	3000K	0.98kg	2000522	D15W176*176RE3KW
30W	Twin module	2390lm	80lm/W	3000K	2.05kg	2000531	D30W320*176RE3KW



APPLICATIONS

- Retail
- Cafes
- Restaurants
- Hotels

COLOUR AND VARIANTS



SINGLE MODULE



TWIN MODULE

LIGHT OPTICS



45 degree beam spread with precise circular beam output.

DRIVER

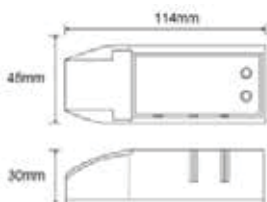

10/15W DRIVER

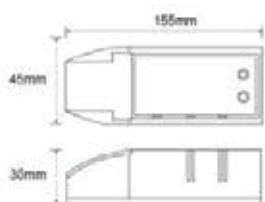

20/30W DRIVER

DIAGRAMS

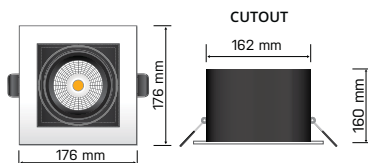

XBOX 15W SINGLE WITH BOX

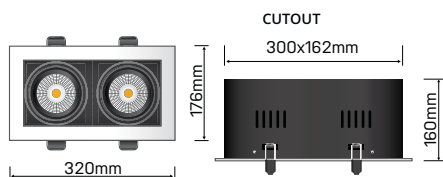

XBOX 30W TWIN WITH BOX



Aurora Square



STANDARDS



The AURORA SQUARE is a range of commercial downlights with low glare design providing comfortable lighting. This stylish square downlight emits a powerful light for indoor applications and protected outdoor areas. It is ideal for residential or retail applications.

- Available in a range of sizes: 13W / 115mm, 18W / 150mm, 26W / 190mm, 28W / 230mm
- Remote driver
- Complete with flex and plug for ease of installation
- Low glare square recessed opal diffuser
- Select models with IP54 rating (*protected outdoor use or in wet areas*)
- Diecast aluminium construction

SPECIFICATIONS

AURORA SQUARE

POWER	IP RATING	LUMEN	lm/W	CCT	WEIGHT	SAP CODE	PRODUCT CODE
13W	IP54	830lm	64lm/W	3000K	0.70kg	2000053	AURORASQ115A01
		910lm	70lm/W	5000K		2000054	AURORASQ115A02
18W	IP54	1380lm	77lm/W	5000K	1.30kg	2000056	AURORASQ150A02
		2010lm	77lm/W	4000K		2000058	AURORASQ190A4K
26W	IP40	2070lm	80lm/W	5000K	1.40kg	2000057	AURORASQ190A02
				3000K		2000059	AURORASQ220A01
28W	IP40	2460lm	88lm/W	4000K	1.40kg	2000061	AURORASQ220A4K
				5000K		2000060	AURORASQ220A02

APPLICATIONS

- Retail
- Hospitality
- Commercial

COLOUR AND VARIANTS



LIGHT OPTICS



90 degree beam spread with precise circular beam output.

DIAGRAMS

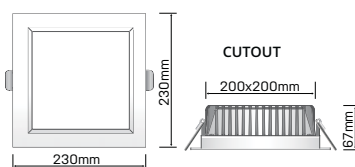
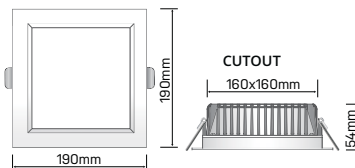
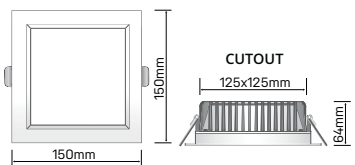
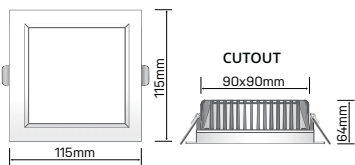

DRIVER

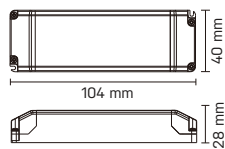

AURORA SQ 13W

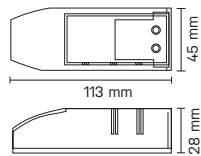

AURORA SQ 18W

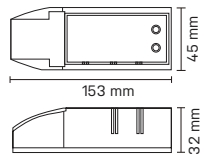

AURORA SQ 26W

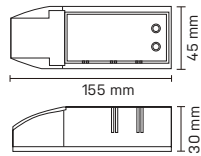

AURORA SQ 28W



Surface mount

Downlights / Oysters range

Surface mount lighting provides an installation solution where a minimum ceiling depth is available or is not able to be recessed. Oysters allow for more light coverage with fewer shadows. They are an easy-to-install light fitting and are available in emergency and sensor options.



*Featured:
METEOR*





SURFACE MOUNT



Meteor



STANDARDS

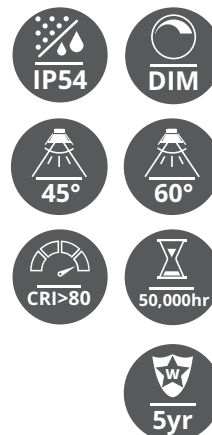

The METEOR is a surface mounted tubular downlight with a recessed clear lens. With multifaceted specular reflector it provides optimum glare control. It is ideal for indoor and outdoor applications.

- Multifaceted reflector for optimum glare control
- Available in 15W – 90mm and 35W – 160mm
- Anodised heatsink for optimal performance
- Choice of sizes, intensities and finishes
- Powder coated aluminium construction
- Available in Matte White or Matte Black

SPECIFICATIONS

METEOR

POWER	BEAM ANGLE	FEATURE	LUMEN	lm/W	CCT	WEIGHT	SAP CODE	PRODUCT CODE
15W	45°	Matte White	1170lm	78lm/W	3000K	0.40kg	2000329	M15W90R3K45DC
			1190lm	79lm/W	4000K	0.40kg	2000332	M15W90R4K45DC-W
		Matte Black	1170lm	78lm/W	3000K	0.40kg	2000330	M15W90R3K45DC-B
			1190lm	79lm/W	4000K	0.40kg	2000331	M15W90R4K45DC-B
35W	60°	Matte White	2880lm	82lm/W	3000K	1.20kg	2000729	M35W160R3K60DC
			3020lm	87lm/W	4000K	1.20kg	2000333	M35W160R4K60DC
		Matte Black	2880lm	82lm/W	3000K	1.20kg	2000647	M35W160R3K60DC-B
			3020lm	86lm/W	4000K	1.20kg	2000334	M35W160R4K60DC-B

APPLICATIONS

- Retail
- Hospitality
- Commercial
- Residential
- Bathrooms
- Architectural

COLOUR AND VARIANTS



WHITE



BLACK



15W

M15W90R3K45DC
M15W90R4K45DC-W
M15W160R3K60DC



35W

M35W160R3K60DC
M35W160R4K60DC



15W

M15W90R3K45DC-B
M15W90R4K45DC-B



35W

M35W160R3K60DC-B
M35W160R4K60DC-B

LIGHT OPTICS



45/60°

45 degree for 15W model
60 degree for 35W model

DIAGRAMS

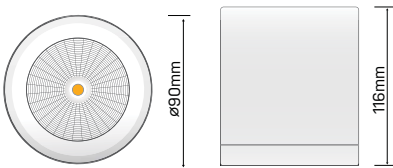

METEOR 15W

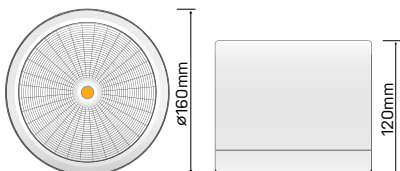

METEOR 35W





Puro G2

STANDARDS

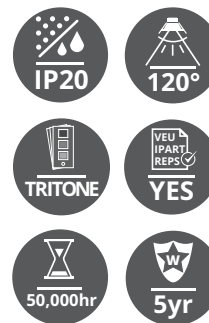

The PURO G2 is a range of LED oyster lights providing Tritone colour selection, smooth light distribution and a flicker-free technology. This light is perfect for indoor residential applications.

- Tritone selectable - 3000K, 4000K, 5000K
- Durable white powder coated steel base
- Available in 250mm, 300mm and 400mm
- Opal PMMA twist lock diffuser for ease of installation
- Integral flicker free driver (*non-sensor versions*)
- Emergency (EM) and Intellisensor (MS) versions available

SPECIFICATIONS

PURO G2

POWER	LUMEN	lm/W	CCT	WEIGHT	SAP CODE	PRODUCT CODE
12W	960lm	80lm/W	3000K	0.31kg	2001985	PURO12W250R
	1140lm	95lm/W	4000K			
	1080lm	90lm/W	5000K			
15W	1210lm	80lm/W	3000K	0.50kg	2001986	PURO15W300R
	1370lm	91lm/W	4000K		2001987	PURO15W300R-MS
	1340lm	89lm/W	5000K			
25W	2140lm	85lm/W	3000K	0.70kg	2001988	PURO25W400R
	2420lm	97lm/W	4000K		2001990	PURO25W400R-MS
	2330lm	93lm/W	5000K			
	2140lm	85lm/W	3000K	1.1kg	2001989	PURO25W400R-EM
	2420lm	97lm/W	4000K		2001991	PURO25W-EM-MS
	2330lm	93lm/W	5000K			

EM (Emergency battery backup) MS (Motion Sensor)

APPLICATIONS

- Residential
- Hallways
- Stairwells
- Porches
- Interior ceilings
- Hospitality
- Utility Rooms

COLOUR AND VARIANTS



LIGHT OPTICS



Clean circular 120 degree beam output.

DIAGRAMS

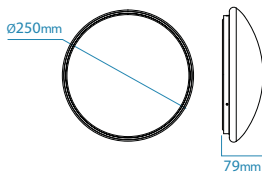

PURO 12W

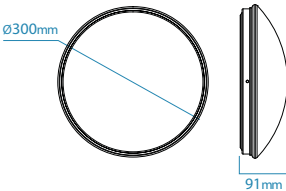

PURO 15W

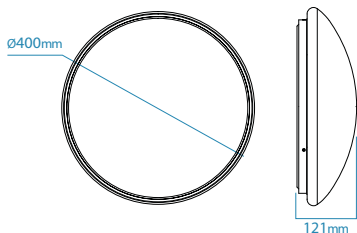

PURO 25W



Puro 350



STANDARDS

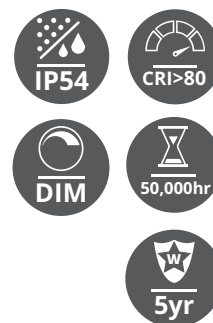

The PURO 350 is an ideal bright oyster light for exterior walls and under eaves. The opal acrylic diffuser provides even light distribution to the space and has a large terminal block for easy installation.

- Available in 4000K or 5000K
- IP54 for protected outdoor use or wet areas
- Polycarbonate base with opal acrylic diffuser
- Large terminal block
- Weatherproof and insect resistant design
- Integral dimmable driver

SPECIFICATIONS

PURO 350

POWER	LUMEN	lm/W	CCT	WEIGHT	SAP CODE	PRODUCT CODE
21W	1380lm	66lm/W	4000K	1.22kg	200107	CL21W350R4K120DF
	1420lm	68lm/W	5000K		200108	CL21W350R5K120DF

APPLICATIONS

- Residential
- Exterior walls
- Under eaves
- Stairs

COLOUR AND VARIANTS



WHITE



LIGHT OPTICS



Clean circular 120 degree beam output.

DIAGRAMS

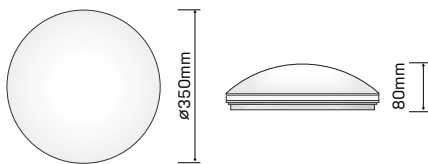

SURFACE MOUNT



Discus



STANDARDS



The DISCUS is a sleek, aesthetically designed oyster light with slim body profile and IP54 protection rating that allows the fitting to be installed in both indoor and outdoor applications. It comes in Intellisensor (MS) and emergency (EM) versions.

- Tritone selectable - 3000K, 4000K, 5700K
- IP54 Protection for damp area installations
- Polycarbonate body and opal acrylic diffuser
- Robust vandal resistant construction
- External dip switches for sensor configuration
- Emergency (EM) and Intellisensor (MS) versions available

SPECIFICATIONS

DISCUS

POWER	LUMEN	lm/W	CCT	WEIGHT	SAP CODE	PRODUCT CODE
12W	1190lm	99lm/W	3000K	0.65kg	2001934	DISC12W250R
	1260lm	105lm/W	4000K			
	1210lm	101lm/W	5700K			
25W	2040lm	81lm/W	3000K	0.75kg	2001935	DISC25W300R
	2190lm	87lm/W	4000K			
	2080lm	83lm/W	5700K			
30W	2800lm	93lm/W	3000K	0.95kg	2001939	DISC30W400R
	3040lm	101lm/W	4000K			
	2910lm	97lm/W	5700K			
25W	2040lm	81lm/W	3000K	1.2kg	2001936	DISC25W300R-EM
	2190lm	87lm/W	4000K		2001937	DISC25W300R-MS
	2080lm	83lm/W	5700K		2001938	DISC25W-EM-MS

EM (Emergency battery backup) MS (Motion Sensor)

APPLICATIONS

- Retail
- Commercial
- Residential
- Schools
- Offices
- Exterior Walls
- Under Eaves
- Stairwells

COLOUR AND VARIANTS



LIGHT OPTICS

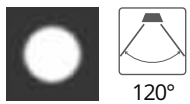

Clean circular 120 degree beam output.

DIAGRAMS

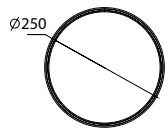

DISCUS 12W

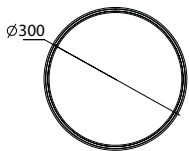

DISCUS 25W

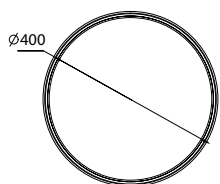

DISCUS 30W





Track Light

Spotlighting

When an object is lit directly from above, the illumination and effect is intensely different to when an object is lit from below. With a wide range of LED strip, profile and track lighting, the design task becomes simple.



*Featured:
FOCI white*





Foci

STANDARDS



The FOCI is an adjustable LED track light with a narrow beam (35°) for precise positioning. It is manufactured from diecast aluminium with an extruded aluminium driver box in horizontal position for superior thermal control.

- Three circuit adjustable LED track light
- Die-cast aluminium body with powder-coated finish
- Optional 15° and 24° beam angle accessories
- Tilts 90° and rotates 350°
- Narrow beam angle 35°
- Available in white or black

SPECIFICATIONS

FOCI

POWER	LUMEN	FEATURE	lm/W	CCT	WEIGHT	SAP CODE	PRODUCT CODE
25W	2110lm	Black	84lm/W	3000K	1.12kg	2001335	FOCI25W-B3KTRK
		White	84lm/W			2001336	FOCI25W-W3KTRK
	2270lm	Black	91lm/W	4000K	1.12kg	2001337	FOCI25W-B4KTRK
		White	91lm/W			2001338	FOCI25W-W4KTRK

APPLICATIONS

- Retail
- Galleries
- Accent lighting

COLOURS



LIGHT OPTICS



35 degree beam spread with precise circular beam output.

DIAGRAMS

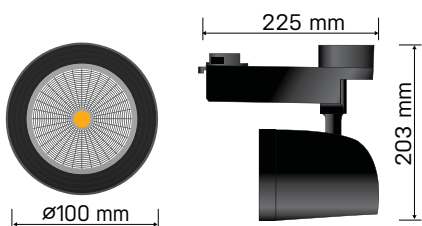
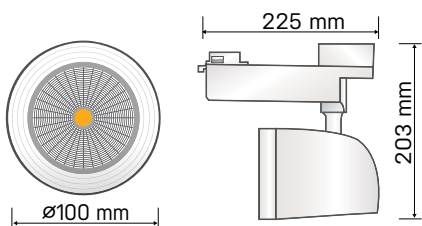

ACCESSORIES



BEAM ADJUSTMENT REFLECTOR

Replacement reflectors for FOCI track light -
beam angle 15° or 24°

BEAM ANGLE	SAP CODE	PRODUCT CODE
15°	2001380	FOCI-RF15D
24°	2001381	FOCI-RF24D

FOCI ACCESSORIES OVERVIEW (see next page)



3 CIRCUIT TRACK



180° FLEXIBLE TRACK BRACKET



90° SIMPLE FIT BRACKET



180° SIMPLE FIT BRACKET



240V INITIAL FEED



SIMPLE FIT END CAP



EASY ADJUST
SUSPENSION KIT





3 CIRCUIT TRACK

Available in 1m and 3m lengths, 240V, Black or White



COLOUR	LENGTH	SAP CODE	PRODUCT CODE
White	1m	2000402	SMFWT-WH-1M
Black	1m	2000400	SMFWT-BK-1M
White	3m	2000403	SMFWT-WH-3M
Black	3m	2000401	SMFWT-BK-3M

180° FLEXIBLE TRACK BRACKET

Allows connection of track at 0-180°



COLOUR	SAP CODE	PRODUCT CODE
White	2000419	SMTCN-WH-FD
Black	2000414	SMTCN-BK-FD

90° SIMPLE FIT BRACKET

Allows connection of track at 90°



COLOUR	SAP CODE	PRODUCT CODE
White	2000417	SMTCN-WH-90D
Black	2000412	SMTCN-BK-90D

180° SIMPLE FIT BRACKET

Allows connection of track at 18°



COLOUR	SAP CODE	PRODUCT CODE
White	2000416	SMTCN-WH-180D
Black	2000411	SMTCN-BK-180D

240V INITIAL FEED

Allows connection from power supply

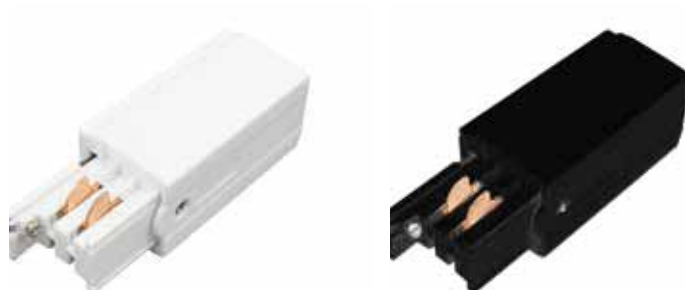

COLOUR	SAP CODE	PRODUCT CODE
White	2000420	SMTCN-WH-INTFEED
Black	2000415	SMTCN-BK-INTFEED

SIMPLE FIT END CAP

Seals end of track



COLOUR	SAP CODE	PRODUCT CODE
White	2000418	SMTCN-WH-ENDCAP
Black	2000413	SMTCN-BK-ENDCAP

EASY ADJUST SUSPENSION KIT

1.2m track suspension kit (1 piece only)



COLOUR	SAP CODE	PRODUCT CODE
White	2000447	SUSPENSION-KIT-WH
Black	2000446	SUSPENSION-KIT-BK

Linear lighting

Continuous luminaires

LED Strip lighting allows cabinets, shelves and under counter areas to be lit effectively without a sophisticated lighting control system. It can highlight the back wall and brighten any area - no space is too small for our energy efficient LED strip lights.



*Featured:
FLEXION G2*





Flexion G2 - 5M Kit

STANDARDS



The FLEXION G2 range of LED strips can be cut and easily mounted making it suitable for indoor feature lighting. It is available in 3 levels of intensity; high, medium or low.

- Easy to install flexible LED strip
- 5m roll with LED driver
- Complete with flex and plug for ease of installation
- Phase cut dimming options available on request
- 24V Extra low safe voltage
- Further reduced trimmable length (*at indicated points*)
- Secure with adhesive backing to clean smooth surface
- Optional dimmable drivers available

SPECIFICATIONS

FLEXION G2 - 5M KIT

WATTS	FEATURE	IP RATING	LEDs per meter	CUTTING INTERVALS	LUMEN PER METER	lm/W	CCT	SAP CODE	PRODUCT CODE
25W	Low Intensity 5 W/m (power per meter)	IP20	60	100mm	531lm	105lm/w	3000K	2002017	FX25W5M3K-IP20
			60	100mm	533lm	105lm/w	4000K	2002015	FX25W5M4K-IP20
			60	100mm	510lm	105lm/w	6500K	2002013	FX25W5M6K-IP20
		IP65	60	100mm	505lm	105lm/w	3000K	2002018	FX25W5M3K-IP65
			60	100mm	514lm	105lm/w	4000K	2002016	FX25W5M4K-IP65
			60	100mm	494lm	105lm/w	6500K	2002014	FX25W5M6K-IP65
40W	Medium Intensity 8 W/m (power per meter)	IP20	120	50mm	668lm	100lm/w	3000K	2002023	FX40W5M3K-IP20
			120	50mm	696lm	100lm/w	4000K	2002021	FX40W5M4K-IP20
			120	50mm	706lm	100lm/w	6500K	2002019	FX40W5M6K-IP20
		IP65	120	50mm	626lm	100lm/w	3000K	2002024	FX40W5M3K-IP65
			120	50mm	585lm	100lm/w	4000K	2002022	FX40W5M4K-IP65
			120	50mm	521lm	100lm/w	6500K	2002020	FX40W5M6K-IP65
75W	High Intensity 15 W/m (power per meter)	IP20	160	31.25mm	1299lm	90lm/w	3000K	2002029	FX75W5M3K-IP20
			160	31.25mm	1463lm	90lm/w	4000K	2002027	FX75W5M4K-IP20
			160	31.25mm	1415lm	90lm/w	6500K	2002025	FX75W5M6K-IP20
		IP65	160	31.25mm	1135lm	90lm/w	3000K	2002030	FX75W5M3K-IP65
			160	31.25mm	1158lm	90lm/w	4000K	2002028	FX75W5M4K-IP65
			160	31.25mm	996lm	90lm/w	6500K	2002026	FX75W5M6K-IP65

APPLICATIONS

- Cafes, restaurants
- Lobbies
- Stairs
- General back lighting
- Cove lighting
- Feature lighting
- Shadow gaps

DRIVERS

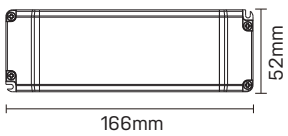

25W / 40W DRIVER

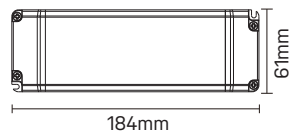

75W DRIVER

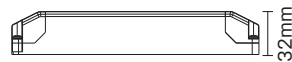
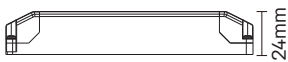

DIAGRAMS



IP20 FLEXION

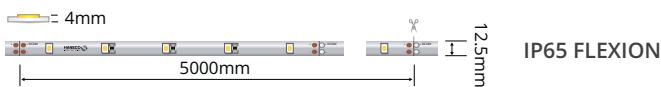

IP65 FLEXION



Flexion G2 - 50M



STANDARDS



The FLEXION G2 range of LED strips can be cut and easily mounted making it suitable for indoor feature lighting. It is available in 3 levels of intensity; high, medium or low.

- 50m roll easy install flexible LED strip
- 24V extra low safe voltage
- Further reduced trimmable length (*at indicated points*)
- Secure with adhesive backing to clean smooth surface
- Phase cut dimming options available on request
- 5 year warranty

SPECIFICATIONS

FLEXION G2 - 50M

WATTS	FEATURE	IP RATING	LEDs per meter	CUTTING INTERVALS	LUMEN PER METER	lm/W	CCT	SAP CODE	PRODUCT CODE
250W	Low Intensity 5 W/m (power per meter)	IP20	60	100mm	531lm	105lm/w	3000K	2002076	FX5W1M3K-50M
			60	100mm	533lm	105lm/w	4000K	2002075	FX5W1M4K-50M
			60	100mm	510lm	105lm/w	6500K	2002074	FX5W1M6K-50M
400W	Medium Intensity 8 W/m (power per meter)	IP20	120	50mm	668lm	100lm/w	3000K	2002079	FX8W1M3K-50M
			120	50mm	696lm	100lm/w	4000K	2002078	FX8W1M4K-50M
			120	50mm	706lm	100lm/w	6500K	2002077	FX8W1M6K-50M
750W	High Intensity 15 W/m (power per meter)	IP20	160	31.25mm	1299lm	90lm/w	3000K	2002082	FX15W1M3K-50M
			160	31.25mm	1463lm	90lm/w	4000K	2002081	FX15W1M4K-50M
			160	31.25mm	1415lm	90lm/w	6500K	2002080	FX15W1M6K-50M

APPLICATIONS

- Cafes, restaurants
- Lobbies
- Stairs
- General back lighting
- Cove lighting
- Feature lighting
- Shadow gaps

DIAGRAMS



LINEAR LIGHTING



Flexion RGB kit

STANDARDS



The FLEXION RGB colour strip range with controllable intensity. It features 15 colours and a choice of either static colour or a range of dynamic colour changes with a remote control.

- Flexible PCB and quality 3M Double Sided Tape for ease of mounting
- Complete with flex and plug for ease of installation
- 24 Button IR remote control with multiple functions
- Selection of 20 modes and 15 colours including white

SPECIFICATIONS

FLEXION RGB KIT

FEATURE	POWER PER METER	LUMEN PER METER	lm/W	SAP CODE	PRODUCT CODE
IP54	8 W/m	58lm/m	R	2001480	FS40W5MRGB30-IP54
		112lm/m	G		
		32lm/m	B		
		195lm/m	White		
	15 W/m	110lm/m	R	2001472	FS75W5MRGB60-IP54
		216lm/m	G		
		60lm/m	B		
		366lm/m	White		

APPLICATIONS

- Cafes, restaurants
- Lobbies
- Stairs
- General back lighting
- Cove lighting
- Feature lighting
- Shadow gaps

DRIVERS

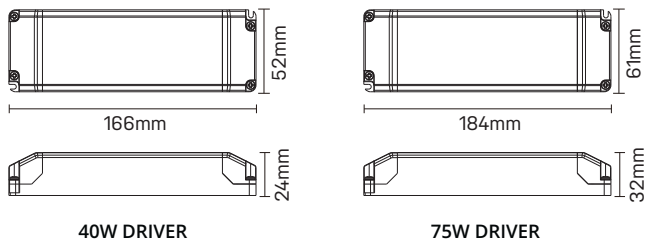

DIAGRAMS

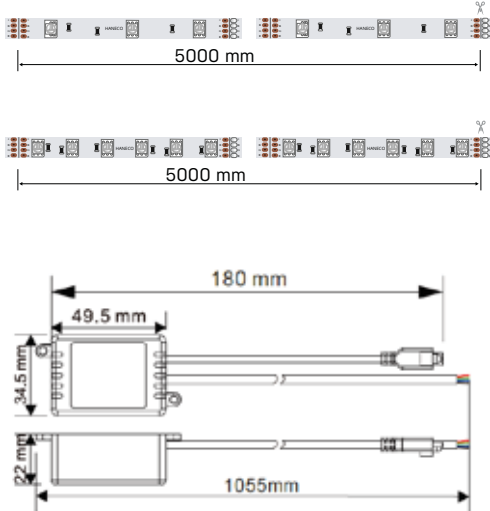

REMOTE RECEIVER



LINEAR LIGHTING



Flexion Drivers







KEY FEATURES

- The Constant Voltage Dimmable or Non-Dimmable Driver is for Haneco strip lights (FLEXION) specified to 24V
- Select dimmable or non dimmable
- Select indoor IP20 or outdoor up to IP67 rated
- Select wattage required

Haneco Driver Calculation Assistant

Strip intensity X Customised Lengths = Total Wattage Needed*

	 WATT/M	X	 LENGTH	=	 TOTAL WATT	 SUITABLE DRIVERS
Example	8W/m	X	4m	=	32W	50W HD-0050-24V & 40W HN-0040-24V
		X		=		
		X		=		

*Maximum length of 10m in a single run. Multiple lengths of up to 10m can be operated from a single source of power, provided that the wattage required does not exceed the driver wattage.

Non-Dimmable Drivers

WATT	MOISTURE RATING	IP RATING	VOLTAGE	CURRENT	DIMENSIONS	SAP CODE	PRODUCT CODE
40W	Indoor	20	24V	0-1.7A	L165xW52xH25mm	2000918	HN-0040-24V
75W	Indoor	20	24V	0-3.15A	L183xW60xH31mm	2000988	HN-0075-24V
75W	Outdoor	65	24V	0-3.15A	L186xW64xH39mm	2000611	HN-0075-24V-IP65
100W	Outdoor	67	24V	0-4.2A	L191xW70xH40mm	2000613	HN-0100-24V
150W	Outdoor	67	24V	0-6.3A	L280xW160xH50mm	2000616	HN-0150-24V
240W	Outdoor	67	24V	0-10A	L249xW72xH40mm	2000265	HN-0240-24V

NB: Outdoor driver is IP67 refer p197 for IP rating standards details,

Dimmable Drivers

WATT	MOISTURE RATING	IP RATING	VOLTAGE	CURRENT	DIMENSIONS	SAP CODE	PRODUCT CODE
25W	Indoor	20	24V	0.2-1.04A	L128xW52xH30mm	2000828	HD-0025-24V
50W	Indoor	20	24V	0.5-2.08A	L184xW61xH32mm	2000829	HD-0050-24V
200W	Outdoor	67	24V	2.7-8.3A	L249xW72xH40mm	2000830	HD-0200-24V

NB: Outdoor driver is IP67 refer p197 for IP rating standards details,

FLEXION UNIVERSAL ACCESSORIES



TYPE	FITS	PRODUCT CODE
IP65 SEALER	FLEXION IP65	FLEXSEALER



TYPE	FITS	PRODUCT CODE
IP65 TERMINAL	FLEXION IP65	FLEXCOVER



TYPE	FITS	PRODUCT CODE
SADDLES	FLEXION IP65	FLEXSDL

FLEXION ACCESSORIES OVERVIEW (see next page)



JOINER FOR
FLEXION IP20



RIGHT ANGLE JOINER
FOR FLEXION IP20



5M STRIP TO
POWER CONNECTOR
FOR FLEXION IP20



150MM STRIP TO
POWER CONNECTOR
FOR FLEXION IP20



150MM STRIP TO
POWER CONNECTOR
FOR FLEXION IP20



30M STRIP CABLE
FOR FLEXION IP20



IP65 MALE TO FEMALE FOR
FLEXION IP65



JOINER FOR
FLEXION RGB





JOINER FOR FLEXION IP20

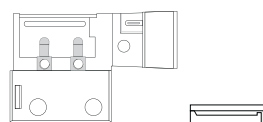

TYPE	ACCESSORY FITS	PRODUCT CODE
JOINER	FLEXION IP20 & IP65	FLEXJNR

RIGHT ANGLE JOINER FOR FLEXION IP20 & IP65

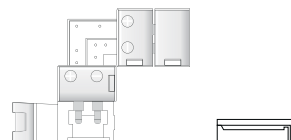

TYPE	ACCESSORY FITS	PRODUCT CODE
RIGHT ANGLE JOINER	FLEXION IP20 & IP65	FLEXCNR

5M CONNECTOR

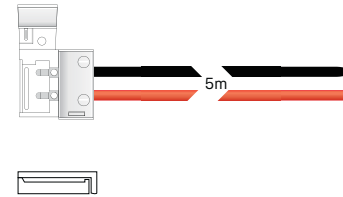

TYPE	ACCESSORY FITS	PRODUCT CODE
5M STRIP TO POWER CONNECTOR	FLEXION IP20 & IP65	FLEXS-P5MIP20

150MM CONNECTOR (5pcs in a pack)



TYPE	ACCESSORY FITS	PRODUCT CODE
150MM STRIP TO POWER CONNECTOR	FLEXION IP20 & IP65	FLEXS-S10MM

150MM CONNECTOR FOR FLEXION IP20

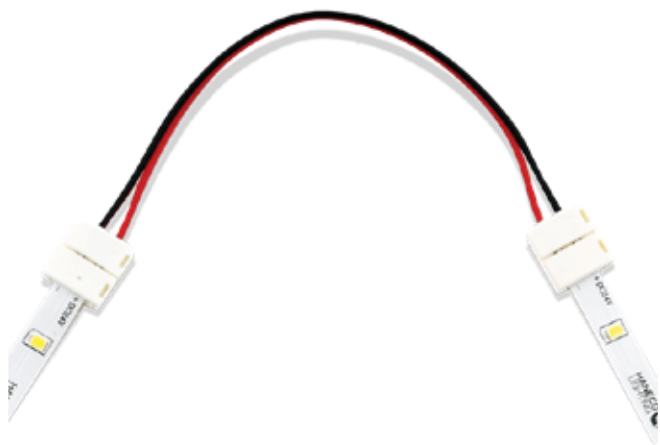

TYPE	ACCESSORY FITS	PRODUCT CODE
150MM STRIP TO STRIP CONNECTOR	FLEXION IP20 & IP65	FLEXS-P10MM

30M STRIP CABLE FOR FLEXION IP20



TYPE	ACCESSORY FITS	PRODUCT CODE
30M STRIP CABLE	FLEXION IP20 & IP65	FLEXCBL30M

MALE TO FEMALE CONNECTOR FOR FLEXION IP65

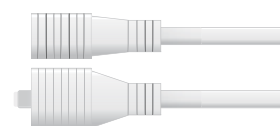

TYPE	ACCESSORY FITS	PRODUCT CODE
IP65 MALE TO FEMALE	FLEXION IP65	FLEXMFC

JOINER FOR FLEXION RGB

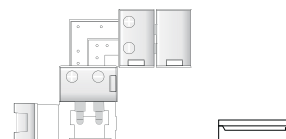

TYPE	ACCESSORY FITS	PRODUCT CODE
JOINER	FLEXION IP20 & IP65	FLEXCNR-RGB

Parallax

Surface Mount Aluminium Profile

The stylish PARALLAX LED Profile range comes with different shapes and sizes for different applications. The surface mount range includes low profile, square and up/down extrusions that will suit any design requirements.

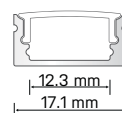

TYPE	LENGTH	FITS	SAP CODE	PRODUCT CODE
17mm Diffuser Low Profile	2M	1 LED Strip IP20	2000995	PARALLAX17X8LP2M

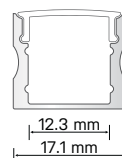

TYPE	LENGTH	FITS	SAP CODE	PRODUCT CODE
17mm Diffuser Low Profile	2M	1 LED Strip IP20/IP65	2000997	PARALLAX17X15SQ2M

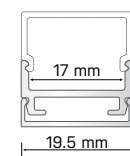

TYPE	LENGTH	FITS	SAP CODE	PRODUCT CODE
20mm Diffuser 180° Wide Beam	2M	1 LED Strip IP20/IP65	2000999	PARALLAX20X20SQ2M

Parallax

Recessed Aluminium Profile

The stylish PARALLAX LED Recessed Profile range comes with different shapes and sizes for different applications. The recessed range comes in different width that will suit any discreet design requirements.

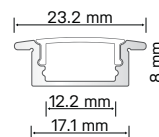

TYPE	LENGTH	FITS	SAP CODE	PRODUCT CODE
23mm Curve Diffuser	2M	1 LED Strip IP20	2001001	PARALLAX23REC2M

Corner Aluminium Profile

The stylish PARALLAX LED Corner Profile range comes with different shapes and sizes for different applications. The corner range comes in a square or round diffuser.

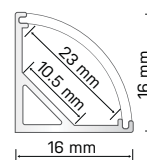

TYPE	LENGTH	FITS	SAP CODE	PRODUCT CODE
23mm Round Diffuser	2M	1 LED Strip IP20/IP65	2001009	PARALLAXCNR23RD2M

Indoor Batten range

Effectively illuminates large areas with a cost-effective LED Batten. These environmentally friendly indoor battens light up spaces and are great to illuminate pathways as well.



*Featured:
VISTA linkable linear batten*







Vista linkable



STANDARDS



The slimline VISTA LINKABLE is Tritone selectable and comes with mounting accessories that allows for quick and easy installation. Compact and seamless connection makes it ideal for any linear lighting application including accent, cove, shelf and under cabinet lighting.

- Tritone selectable - 3000K, 4000K, 5700K
- Available in 300mm, 600mm, 900mm and 1200mm
- Easily accessible CCT and ON/OFF power switches
- The maximum length for VISTA linkable is 8m
- Supplied with 1.2m flex and plug, end cap, mounting clips and straight coupler (*flexible coupler sold separately*)

SPECIFICATIONS

VISTA LINKABLE

FEATURE	POWER	LUMEN	lm/W	CCT	WEIGHT	SAP CODE	PRODUCT CODE
300mm	4.5W	410lm	91lm/W	3000K	0.11kg	2001919	VISTA-LK4W03
		480lm	107lm/W	4000K			
		450lm	100lm/W	5700K			
600mm	9W	810lm	90lm/W	3000K	0.19kg	2001920	VISTA-LK9W06
		1040lm	116lm/W	4000K			
		990lm	110lm/W	5700K			
900mm	13W	1300lm	100lm/W	3000K	0.26kg	2001921	VISTA-LK13W09
		1490lm	115lm/W	4000K			
		1430lm	110lm/W	5700K			
1200mm	18W	1700lm	94lm/W	3000K	0.35kg	2001922	VISTA-LK18W12
		2040lm	113lm/W	4000K			
		2000lm	111lm/W	5700K			

APPLICATIONS

- Residential
- Schools
- Offices
- Galleries
- Retail
- Stairwells

COLOURS



OPTIONS



FLEXIBLE COUPLER 250mm
VISTA-LK4PCNTR

* Sold separately

LIGHT OPTICS

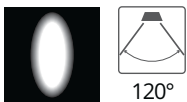

Cut off at 120 degrees.

DIAGRAMS

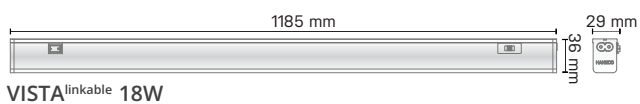
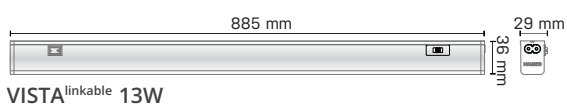
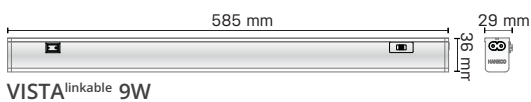
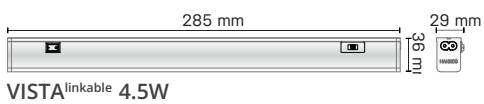



FLEXIBLE COUPLER (4pcs in a pack)

Optional VISTA linkable accessory (sold separately)



PRODUCT NAME	FEATURES	SAP CODE	PRODUCT CODE
Wire Connector (4 pcs in a pack)	Flexible coupler 250mm in length	2001924	VISTA-LK4PCNTR

STRAIGHT COUPLER

Supplied VISTA linkable accessory



* Supplied with VISTA linkable

FLEX AND PLUG / MOUNTING CLIPS

Supplied VISTA linkable accessory



* Supplied with VISTA linkable

END CAPS

Supplied VISTA linkable accessory



* Supplied with VISTA linkable

INDOOR BATTEN



Vistalite

STANDARDS

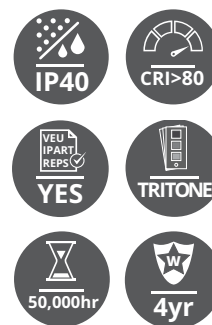

The VISTALITE is a sleek, narrow body batten. A low cost option for either for new installations or to replace single battens without compromising on features.

- Tritone selectable - 4000K, 4700K, 5700K
- Dual power selection available in 1200mm length
- Easy access terminal block (*on standard models*)
- Narrow body batten for new or retrofit applications
- Emergency (EM) versions available

SPECIFICATIONS

VISTALITE

NOMINAL LENGTH 600mm (Standard mode)

POWER	LUMEN	lm/W	CCT	WEIGHT	SAP CODE	PRODUCT CODE
20W	2150lm	108lm/W	4000K	0.90kg	2001630	VSL20W06-TRI
	2260lm	113lm/W	4700K			
	2130lm	107lm/W	5700K			

NOMINAL LENGTH 1200mm (Standard and Low Power modes)

STANDARD MODE			LOW POWER MODE						
POWER	LUMEN		POWER	LUMEN	lm/W	CCT	WEIGHT	SAP CODE	PRODUCT CODE
40W	4220lm			2100lm	105lm/W	4000K	1.80kg	2001634	VSL20W40W12-TRI
	4540lm		20W	2330lm	117lm/W	4700K			
	4610lm			2390lm	120lm/W	5700K			

EMERGENCY MODEL SPECIFICATIONS

NOMINAL LENGTH 600mm (Standard mode)

POWER	LUMEN	lm/W	CCT	WEIGHT	SAP CODE	PRODUCT CODE
20W	2080lm	104lm/W	4000K	1.90kg	2001631	VSL20W06-TRI-EM
	2230lm	112lm/W	4700K			
	2120lm	106lm/W	5700K			

NOMINAL LENGTH 1200mm (Standard and Low Power modes)

STANDARD MODE			LOW POWER MODE				WEIGHT	SAP CODE	PRODUCT CODE
POWER	LUMEN	lm/W	POWER	LUMEN	lm/W	CCT			
40W	4140lm	104lm/W	20W	2100lm	105lm/W	4000K	2.80kg	2001635	VSL20W40W12-TRI-EM
	4540lm	113lm/W		2330lm	117lm/W	4700K			
	4610lm	115lm/W		2390lm	119lm/W	5700K			

APPLICATIONS

- Retail
- Offices
- Colleges, schools
- Corridors
- Workshops

LIGHT OPTICS



COLOURS



DIAGRAMS

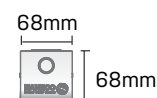
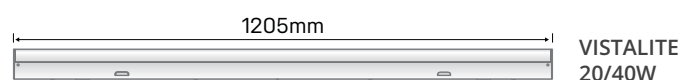
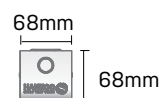
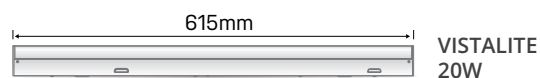





Vista



STANDARDS



The VISTA is the perfect LED replacement for conventional battens. It enhances energy savings by offering efficiency and smart technology such as Intellisensor and Ecoswitch.

- Tritone selectable - 4000K, 4700K, 5700K
- Dual intensity selection with Ecoswitch (*non-sensor models*)
- Quick and easy installation
- 20mm cable entry, optional knockout and cables to suspend light while attaching the body
- Emergency (EM) and Intellisensor (MS) versions available

SPECIFICATIONS

VISTA

NOMINAL LENGTH 600mm (Standard mode)

POWER	LUMEN	lm/W	CCT	WEIGHT	SAP CODE	PRODUCT CODE
20W	2000lm	100lm/W	4000K	0.80kg	2001157	VISTA20W06-TRI
	2200lm	110lm/W	4700K			
	2100lm	105lm/W	5700K			

NOMINAL LENGTH 1200mm (Standard and Low Power modes)

STANDARD MODE		LOW POWER MODE			WEIGHT	SAP CODE	PRODUCT CODE
POWER	LUMEN	POWER	LUMEN	lm/W			
40W	4540lm	20W	2400lm	120lm/W	4000K	2.0kg	VISTA20/40W12-TRI
	4880lm		2510lm	126lm/W	4700K		
	4470lm		2430lm	122lm/W	5700K		

NOMINAL LENGTH 1500mm (Standard mode)

POWER	LUMEN	lm/W	CCT	WEIGHT	SAP CODE	PRODUCT CODE
60W	6300lm	105lm/W	4000K	2.5kg	2001162	VISTA60W15-TRI
	6690lm	112lm/W	4700K			
	6250lm	104lm/W	5700K			

EMERGENCY MODEL SPECIFICATIONS

NOMINAL LENGTH 600mm (Standard mode)

POWER	LUMEN	lm/W	CCT	WEIGHT	SAP CODE	PRODUCT CODE
20W	2000lm	100lm/W	4000K	0.80kg	2001158	VISTA20W06-TRI-EM
	2200lm	110lm/W	4700K			
	2100lm	105lm/W	5700K			

NOMINAL LENGTH 1200mm (Standard and Low Power modes)

STANDARD MODE			LOW POWER MODE				WEIGHT	SAP CODE	PRODUCT CODE
POWER	LUMEN	lm/W	POWER	LUMEN	lm/W	CCT			
20-40W	4540lm	114lm/W	20W	2400lm	120lm/W	4000K	2.00kg	2001063	VISTA20/40W12-TRI-EM
	4880lm	122lm/W		2510lm	126lm/W	4700K			
	4470lm	112lm/W		2430lm	122lm/W	5700K			

NOMINAL LENGTH 1200mm (Standard mode)

POWER	LUMEN	lm/W	CCT	WEIGHT	SAP CODE	PRODUCT CODE
40W	4120lm	114lm/W	4000K	1.90kg	2002111	VISTA12-SS
	4570lm	122lm/W	4700K			
	4300lm	112lm/W	5700K	2.00kg	2001065	VISTA40W12-TRI-SS-EM

APPLICATIONS

- Retail
- Offices
- Colleges, schools
- Corridors
- Workshops

LIGHT OPTICS

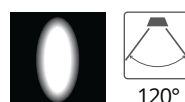

Cut off at 120 degrees.

COLOURS



WHITE

ACCESSORIES



Configuration Controller
BATTEN-REMOTE
SAP. 2002151
(Sensor Models)

DIAGRAMS

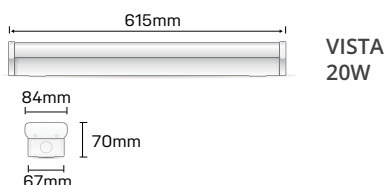

VISTA
20W

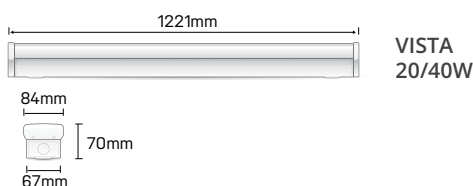

VISTA
20/40W

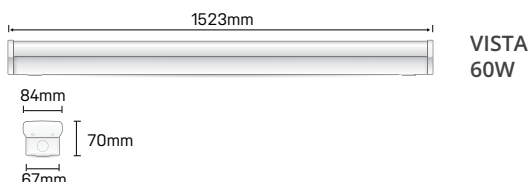

VISTA
60W



INDOOR BATTEN



Vista plus



STANDARDS



The VISTA PLUS is a premium wide body (110mm) LED batten with a stylish, smooth, satin polycarbonate diffuser. VISTA PLUS comes with both Intellisensor (MS) and emergency (EM) versions.

- Tritone selectable - 4000K, 4700K, 5700K
- Elegant LED batten perfect for retrofit
- Powder coated SPCC steel body
- Provides even and uniform light distribution
- Quadruple power selection available (*non-sensor models*)
- Flicker-free driver for softer light

SPECIFICATIONS

VISTA PLUS

	POWER SETTING				CCT	EFFICACY
	40W	32W	29W	20W		
LUMEN OUTPUT	4700lm	3700lm	3300lm	2600lm	4000K	up to 133lm/W
	5000lm	3600lm	3350lm	2650lm	4700K	
	4700lm	3600lm	3300lm	2600lm	5700K	

MODEL LIST

FEATURE	POWER SETTING	WEIGHT	SIZE	SAP CODE	PRODUCT CODE
110mm Wide Body	40 / 32 / 29 / 20W	2.40kg	1221mm	2001925	VISTA-PL12
				2001927	VISTA-PL12-MS
	40W	2.60kg	1221mm	2001926	VISTA-PL12-EM
				2001928	VISTA-PL12 -EM-MS

EM (Emergency battery backup) MS (Motion Sensor)

APPLICATIONS

- Retail
- Office
- Industrial
- Commercial
- Car Parks

COLOURS



WHITE



LIGHT OPTICS



120°

Cut off at 120 degrees.

DIAGRAMS

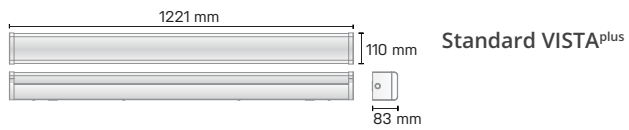



Vista hero



STANDARDS



The VISTA HERO is a conventional but elegant batten that is suitable for either new installations or as a replacement. 1230mm in length and 125mm in width it is also available in Emergency (EM) and Intellisensor (MS) versions.

- Tritone selectable - 4000K, 4700K, 5700K
- Quadruple power selection available (*non-sensor models*)
- Provides even and uniform light distribution
- White powder coated SPCC steel body
- Emergency (EM) and Intellisensor (MS) versions available
- Smooth opal polycarbonate diffuser

SPECIFICATIONS

VISTA HERO

	POWER SETTING				CCT	EFFICACY
	40W	31W	26W	19W		
LUMEN OUTPUT	4130lm	3370lm	3000lm	2190lm	4000K	up to 117lm/W
	4240lm	3440lm	3030lm	2190lm	4700K	
	3880lm	3200lm	2840lm	2090lm	5700K	

MODEL LIST

FEATURE	POWER SETTING	WEIGHT	SAP CODE	PRODUCT CODE
125mm Wide Body	40/31/26/19W	1.9kg	2001940	VISTA-HR12
		2.20kg	2001941	VISTA-HR12-EM
	40W	2.45kg	2001942	VISTA-HR12-MS
		2.55kg	2001943	VISTA-HR12-EM-MS

EM (Emergency battery backup) MS (Motion Sensor)

APPLICATIONS

- Residential retrofit
- Offices
- Garages
- Industrial
- Retail

COLOURS



LIGHT OPTICS



Cut off at 120 degrees.

DIAGRAMS

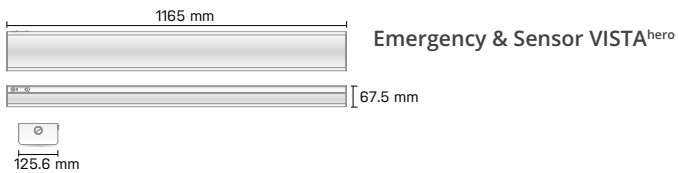
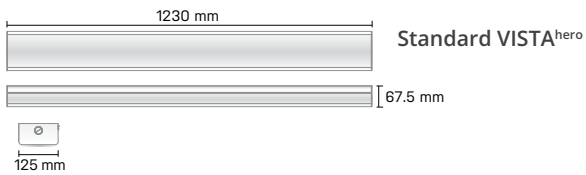

Oxford

STANDARDS

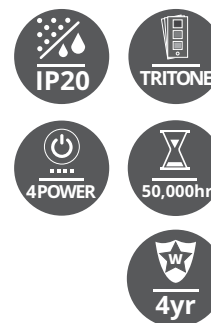

The OXFORD is an extra wide body LED batten with an aesthetically pleasing low glare design minimising clutter on the ceiling for offices, retail and school applications.

- Tritone selectable - 4000K, 4700K, 5700K
- 4 power switchable (*non-sensor versions only*)
- Low glare design with flicker-free driver
- Quick and easy installation
- Emergency (EM) and Intellisensor (MS) versions available
- Simple twist-lock end caps to secure diffuser

SPECIFICATIONS

OXFORD

	POWER SETTING				CCT	EFFICACY
	40W	32W	29W	20W		
LUMEN OUTPUT	4200lm	3620lm	3140lm	2200lm	4000K	up to 115lm/W
	4400lm	3470lm	3280lm	2300lm	4700K	
	4200lm	3440lm	3130lm	2200lm	5700K	

MODEL LIST					
FEATURE	POWER SETTING	WEIGHT	SIZE	SAP CODE	PRODUCT CODE
212mm Super Wide	40 / 32 / 29 / 20W	3.55kg	1220mm	2001885	OXFORD12
		4.00kg		2001886	OXFORD12-EM
	40W	3.60kg	1220mm	2001887	OXFORD12-MS
		4.00kg		2001888	OXFORD12-EM-MS

EM (Emergency battery backup) MS (Motion Sensor)

APPLICATIONS

- Colleges, schools
- Offices
- Retails

COLOURS



LIGHT OPTICS



Cut off at 120 degrees.

DIAGRAMS

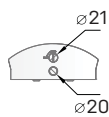

INDOOR BATTEN



Uno



STANDARDS



The UNO is a rigorously styled, strictly essential Tritone selectable luminaire. It offers outstanding performance with a choice of three lengths – 900mm, 1200mm and 1500mm. This batten boasts quick and easy installation with flexible suspended kits, 1.2m flex and plug and surface mount screws.

- Tritone selectable - 3000K, 4000K, 5000K
- Surface mount and suspension kits included
- Slim appearance with elegant opal diffuser
- 900mm - 30W, 1200mm - 40W, 1500mm - 50W
- Powder coated extruded surface aluminium base

SPECIFICATIONS

UNO

LENGTH	POWER	LUMEN	EFFICACY	CCT	SAP CODE	PRODUCT CODE	FINISHES
900mm	30W	2400 lm	80 lm/W	3000K	2001972	UNO30W09BK	Black
		2500 lm	83 lm/W	4000K		2001969	UNO30W09WH
		2400 lm	80 lm/W	5000K			
1200mm	40W	3200 lm	80 lm/W	3000K	2001973	UNO40W12BK	Black
		3700 lm	93 lm/W	4000K	2001970	UNO40W12WH	White
		3400 lm	85 lm/W	5000K			
1500mm	50W	4150 lm	83 lm/W	3000K	2001974	UNO50W15BK	Black
		4250 lm	85 lm/W	4000K	2001971	UNO50W15WH	White
		4200 lm	84 lm/W	5000K			

APPLICATIONS

- Residential
- Office
- Commercial Service
- Space
- Retail
- Museums
- Libraries
- Colleges, Schools

COLOURS



WHITE



BLACK



LIGHT OPTICS



Cut off at 110 degrees.

DIAGRAMS

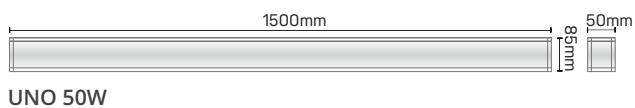
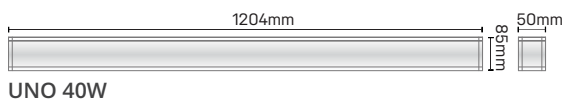
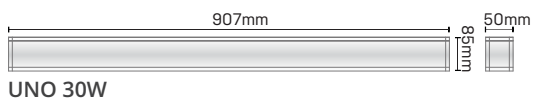

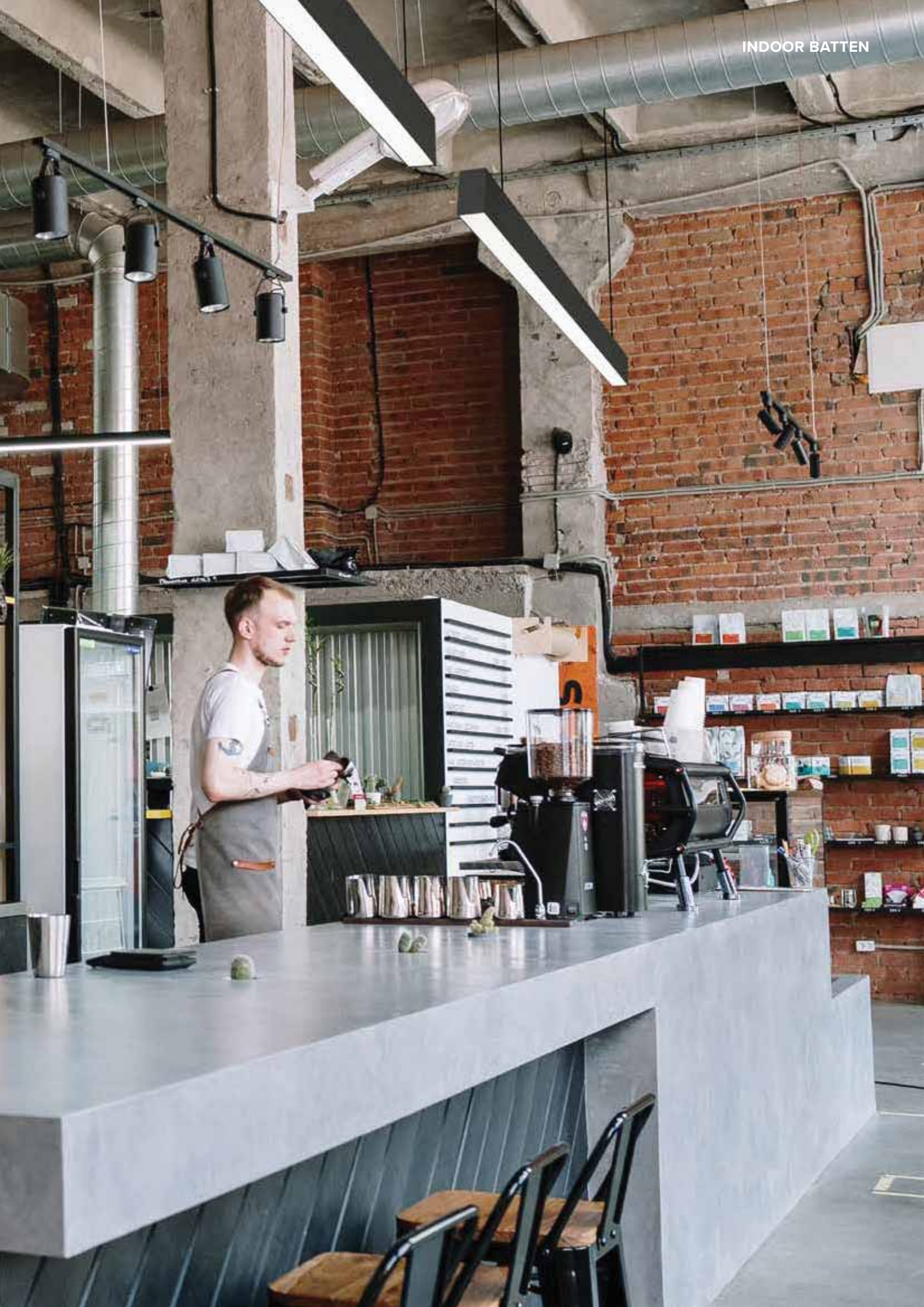

Blade



STANDARDS



The BLADE is a sleek and modern LED batten, ideal when a low profile batten with strong illumination is needed. This aesthetically pleasing batten delivers cost savings without compromising light output.

- Light weight polycarbonate body
- 100mm wide body ideal for retrofit
- 30mm low profile design
- PMMA diffuser
- Double Insulated
- Easy clip on installation

SPECIFICATIONS

BLADE

POWER	LUMEN	lm/W	CCT	WEIGHT	SAP CODE	PRODUCT CODE
20W	2020lm	101lm/W	4000K	0.30kg	2000071	BLADE20W06SM-4K
	1890lm	95lm/W	6000K		2000073	BLADE20W06SM-6K
40W	3970lm	99lm/W	4000K	0.66kg	2000075	BLADE40W12SM-4K
	3770lm	90lm/W	6000K		2000076	BLADE40W12SM-6K

APPLICATIONS

- Retail
- Commercial kitchens
- Offices
- Corridors
- Residential

COLOURS



LIGHT OPTICS



Cut off at 120 degrees.

DIAGRAMS



30mm

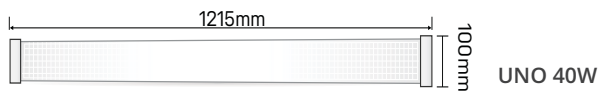

30mm



Outdoor

Batten range

A comprehensive range of weatherproof battens which have been designed, manufactured and tested to last in the Australian environment.



*Featured:
TRIPROOF batten*





OUTDOOR BATTEN



Duralite

STANDARDS



The DURALITE LED batten is ideal for use in utility-type applications such as car parks, workshops, storerooms and back of house areas. It features IP66 ingress protection and an impact resistance rating of IK09,

- Tritone selectable - 4000K, 4500K, 5000K
- Multi intensity weatherproof LED batten
- Anti-corrosive with stainless steel tamper proof clips
- Durable polycarbonate and UV stabilised
- Emergency (EM) and Intellisensor (MS) versions available

SPECIFICATIONS

DURALITE

NOMINAL LENGTH 600mm

POWER	LUMEN	lm/W	CCT	WEIGHT	SAP CODE	PRODUCT CODE
20W	2090 / 2160 / 2070lm	105lm/W	4000K	1.05kg	2001496	DURALITE20W06
17W	1700 / 1800 / 1700lm		4500K			
14W	1400 / 1500 / 1400lm		5000K			
11W	1100 / 1200 / 1100lm					

NOMINAL LENGTH 1200mm

POWER	LUMEN	lm/W	CCT	WEIGHT	SAP CODE	PRODUCT CODE
36W	4160 / 4380 / 4150lm	125lm/W	4000K	2.00kg	2001498	DURALITE18/36W12
30W	3750 / 3800 / 3730lm		4500K			
25W	3130 / 3150 / 3100lm		5000K			
18W	2720 / 2740 / 2680lm					

EMERGENCY MODEL SPECIFICATIONS

NOMINAL LENGTH 600mm

POWER	LUMEN	lm/W	CCT	WEIGHT	SAP CODE	PRODUCT CODE
20W 17W 14W 11W	2090 / 2160 / 2070lm 1700 / 1800 / 1700lm 1400 / 1500 / 1400lm 1100 / 1200 / 1100lm	105lm/W	4000K 4500K 5000K	1.30kg	2001497	DURALITE20W06-EM
20W 18W 16W 15W 13W 12W	2024 / 2164 / 2069lm 1800 / 1890 / 1800lm 1600 / 1680 / 1600lm 1500 / 1580 / 1500lm 1300 / 1350 / 1300lm 1200 / 1250 / 1200lm	105lm/W	4000K 4500K 5000K	1.05kg 1.30kg	2002002 2002003	DURALITE20W06-S DURALITE20W06-SS-EM

NOMINAL LENGTH 1200mm

POWER	LUMEN	lm/W	CCT	WEIGHT	SAP CODE	PRODUCT CODE
36W 30W 25W 18W	4160 / 4380 / 4250lm 3750 / 3800 / 3730lm 3130 / 3150 / 3100lm 2720 / 2740 / 2680lm	125lm/W	4000K 4500K 5000K	2.00kg 2.40kg	2002004 2002005	DURALITE18/36W12-S DURALITE35W12-SS-EM
36W 30W 25W 18W	4160 / 4380 / 4150lm 3750 / 3800 / 3730lm 3130 / 3150 / 3100lm 2720 / 2740 / 2680lm	125lm/W	4000K 4500K 5000K	2.40kg	2001499	DURALITE18/36W12-EM

APPLICATIONS

- Outdoor
- Industrial
- Sport Halls
- Public Amenities

LIGHT OPTICS



Cut off at 120 degrees.

COLOURS



WHITE



DIAGRAMS

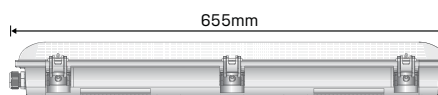

DURALITE 20W

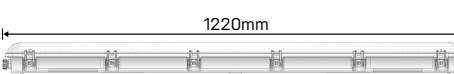
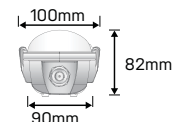

DURALITE 18/36W

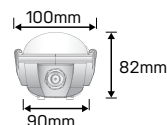

OUTDOOR BATTEN



Triproof



STANDARDS



The TRIPROOF outdoor LED battens feature a robust IK08 vandal resistant construction and are also available with Ecoswitch to minimise waste.

- Tritone selectable - 4000K, 5000K, 6500K
- Durable polycarbonate and UV stabilised
- Stainless steel tamper proof clips
- Vandal resistant construction
- PG16 cable entry with optional knockout
- Emergency (EM) and Intellisensor (MS) versions available
- Quick and easy installation

SPECIFICATIONS

TRIPROOF

NOMINAL LENGTH 600mm (Standard mode)

POWER	LUMEN	lm/W	CCT	WEIGHT	SAP CODE	PRODUCT CODE
20W	1850lm	93lm/W	4000K	2.00kg	2001164	TRIPROOF 20W06-TRI
	1990lm	100lm/W	5000K	2.20kg	2001165	TRIPROOF 20W06-TRI-EM
	1850lm	93lm/W	6500K			

NOMINAL LENGTH 1200mm (Standard and Low Power modes)

STANDARD MODE			LOW POWER MODE				WEIGHT	SAP CODE	PRODUCT CODE
POWER	LUMEN	lm/W	POWER	LUMEN	lm/W	CCT			
40W	4090lm	102lm/W	20W	2230lm	111lm/W	4000K	2.00kg	2001168	TRIPROOF 20/40W12-TRI
	4410lm	110lm/W		2250lm	113lm/W	5000K	2.20kg	2001066	TRIPROOF 20/40W12-TRI-EM
	4050lm	101lm/W		1970lm	98lm/W	6500K			
40W	4090lm	102lm/W	-	-	-	4000K	2.00kg	2002112	TRIPROOF12-SS
	4410lm	110lm/W	-	-	-	5000K	2.20kg	2001068	TRIPROOF 40W12-TRI-SS-EM
	4050lm	101lm/W	-	-	-	6500K			

NOMINAL LENGTH 1500mm (Standard mode)

POWER	LUMEN	lm/W	CCT	WEIGHT	SAP CODE	PRODUCT CODE
60W	5600lm	93lm/W	4000K	3.50kg	2001170	TRIPROOF 60W15-TRI
	6000lm	100lm/W	5000K	3.70kg	2001171	TRIPROOF 60W15-TRI-EM
	5700lm	95lm/W	6500K			

INDUSTRY

- Commercial
- Residential
- Retail

LOCATION

- Corridor
- Kitchen
- Office

COLOURS



ACCESSORIES



Configuration Controller
BATTEN-REMOTE
SAP. 2002151
(Sensor Models)

LIGHT OPTICS



Cut off at 120 degrees.

DIAGRAMS

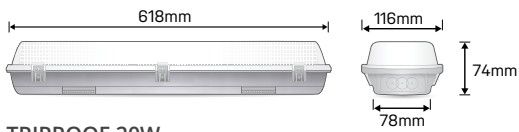

TRIPROOF 20W

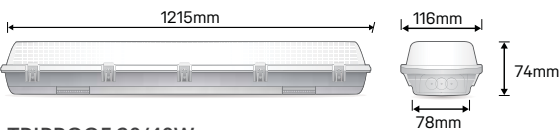

TRIPROOF 20/40W

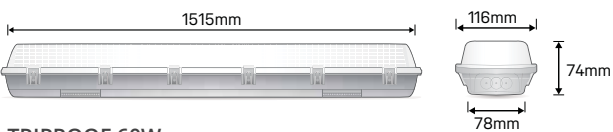

TRIPROOF 60W



Sentry



STANDARDS



The SENTRY is a sturdy outdoor LED batten that is ideal for use as a security light. It features a robust polycarbonate body and diffuser, designed to withstand tough environments (IP66 weather resistant and IK10 vandal resistant). SENTRY is simply ideal for public areas, schools and community centres.

- Tritone selectable - 2700K, 4000K, 6500K
- Robust polycarbonate body and diffuser
- IP66 ingress protection rating
- Polycarbonate body and diffuser
- IK10 vandal resistant rating
- Quick and easy installation

SPECIFICATIONS

SENTRY

POWER	LUMEN	lm/W	CCT	WEIGHT	SAP CODE	PRODUCT CODE
12W	1010lm	84lm/W	2700K	2.00kg	2001495	SENTRY12W06-TRI
	1225lm	102lm/W	4000K			
	1201lm	100lm/W	6500K			

APPLICATIONS

- Building perimeters
- Public facilities
- Subways

COLOURS



WHITE

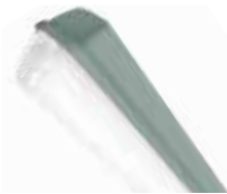

LIGHT OPTICS



Cut off at 120 degrees.

DIAGRAMS

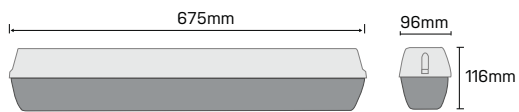

Panel

Panel range

Haneco's LED Panels feature high performance, low glare, flicker-free technology. Supplied standard to fit into T-Bar grid ceilings, there are also accessories to enable surface and suspension mount installations.





PANEL LIGHT



Matrix G3



STANDARDS



The MATRIX G3 panel is Tritone selectable, with a genuine 4000K setting ensuring a pure light at this level. The back-lit panel has been redesigned and manufactured on an automated line, with extra steps built in to ensure the panels have high quality and extra strength to prevent bending.

- Tritone selectable - 4000K, 4500K, 5000K
- Back-lit panel with genuine 4000K
- Perfect for T-bar grid suspended ceilings
- Flicker-free technology
- Phase-cut, 1-10 and DALI dimming on request
- Emergency (EM) versions available

MATRIX G3 300mm wide

SIZE	LUMEN	lm/W	CCT	POWER	WEIGHT	SAP CODE	PRODUCT CODE
300 x 300mm	1930lm 2040lm 1890lm	107lm/W 113lm/W 105lm/W	4000K 4500K 5000K	18W	1.00kg	2001956	MATRIX18W0303
300 x 600mm	2050lm 2000lm 2090lm	114lm/W 111lm/W 116lm/W	4000K 4500K 5000K	18W	1.10kg	2001957	MATRIX18W0306
300 x 1200mm	3210lm 3100lm 3100lm	128lm/W 124lm/W 124lm/W	4000K 4500K 5000K	25W	1.90kg	2001958	MATRIX25W0312

MATRIX G3 600mm wide

SIZE	LUMEN	lm/W	CCT	POWER	WEIGHT	SAP CODE	PRODUCT CODE
600 x 600mm	3000lm 3100lm 3000lm	120lm/W 124lm/W 120lm/W	4000K 4500K 5000K	25W	1.9kg	7000132	MATRIX25W0606
600 x 1200mm	5430lm 5500lm 5680lm	113lm/W 115lm/W 118lm/W	4000K 4500K 5000K	48W	3.9kg	2001962	MATRIX48W0612

MATRIX G3 Power Switchable

SIZE	LUMEN	lm/W	CCT	POWER	WEIGHT	SAP CODE	PRODUCT CODE
600 x 600mm	3000lm 3300lm 3700lm	110lm/W	4000K 4500K 5000K	25W 28W 32W	1.9kg	2002073	MATRIX0606-PS
300 x 1200mm	4100lm		5000K	36W			2002072

APPLICATIONS

- Office
- Education
- Commercial

COLOURS



ADDITIONAL

* Self charging Lithium battery for LED lights during blackouts



**40W EMERGENCY KIT
EMLED-2.4W-3H-60V 40PL**

LIGHT OPTICS

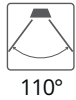

Cut off at 110 degrees.

DIAGRAMS

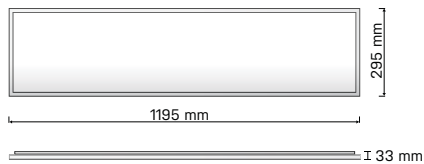

**MATRIX 1200mm
x 300mm**

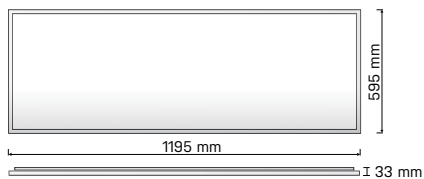

**MATRIX 1200mm
x 600mm**

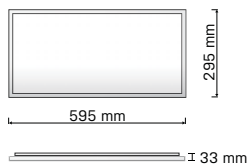

**MATRIX 600mm
x 300mm**

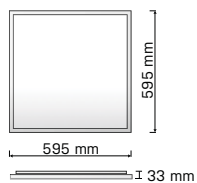

**MATRIX 600mm
x 600mm**



PANEL LIGHT



SURFACE MOUNT FRAME

One piece easy surface mount white frame - made of solid steel

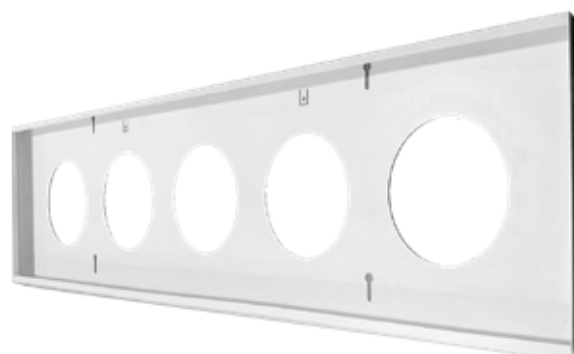

SUITS	DIMENSIONS	SAP CODE	PRODUCT CODE
MATRIX0303 (300 x 300mm)	342 x 375 x 52mm	2001977	SMPF0303-OP-V2
MATRIX0306 (300 x 600mm)	342 x 675 x 52mm	2001978	SMPF0306-OP-V2
MATRIX0312 (300 x 1200mm)	342 x 1275 x 52mm	2001881	SMPF0312-OP-V2
MATRIX0606 (600 x 600mm)	642 x 675 x 52mm	2001979	SMPF0606-OP-V2
MATRIX0612 (600 x 1200mm)	642 x 1275 x 52mm	2001980	SMPF0612-OP-V2

VENTED RECESSED MOUNT FRAME

One piece powder coated white aluminium frame - easy mount with vents (for grid or T-bar ceilings)



SUITS	DIMENSIONS	SAP CODE	PRODUCT CODE
MATRIX0312 (300 x 1200mm)	596 x 1196 x 37mm	2000410	RF0612-AF
MATRIX0312 (300 x 1200mm)	400 x 1195 x 35mm	2001091	RF0412-AF

RECESSED MOUNT FRAME

One piece powder coated white aluminium frame



SUITS	DIMENSIONS	SAP CODE	PRODUCT CODE
MATRIX0303 (300 x 300mm)	330 x 330mm	2000356	PLRF0303
MATRIX0306 (300 x 600mm)	330 x 630mm	2000357	PLRF0306
MATRIX0312 (300 x 1200mm)	330 x 1230mm	2000358	PLRF0312
MATRIX0606 (600 x 600mm)	630 x 630mm	2000359	PLRF0606
MATRIX0612 (600 x 1200mm)	630 x 1230mm	2000360	PLRF0612

SUSPENSION KIT

Steel wire cables



FEATURES	DIMENSIONS	SAP CODE	PRODUCT CODE
Steel wire	0.6m – 2.6m	2001880	SUSKIT-MATRIX

Matrix LG

STANDARDS



The MATRIX LG (Low Glare) provides a UGR<19 lighting solution whilst achieving excellent LUX levels and uniformity. Perfect for both new installations and T-bar fitting replacement, low glare is particularly important in classrooms and office spaces where students or workers spend many hours a day.

- Tritone selectable - 4000K, 4500K, 5000K
- Back-lit panel with high performance >110lm/W
- Is available in sizes 300x1200mm and 600x600mm
- Micro-prismatic PC diffuser eliminates glare
- Compatible with all MATRIX family drivers and accessories

SPECIFICATIONS

MATRIX LG

POWER	DIMENSIONS	lm/W	LUMEN	CCT	WEIGHT	SAP CODE	PRODUCT CODE
25/28W 32/36W	600 x 600mm	>110lm/W	2800lm	4000K	2.0kg	2002040	MTRX0606-PS-LG
	300 x 1200mm		3200lm 3500lm 3900lm	4500K 5000K		2002039	MTRX0312-PS-LG

APPLICATIONS

- Classrooms
- Office
- Education

COLOURS



LIGHT OPTICS



Cut off at 110 degrees.

DIAGRAMS



MATRIX 1200mm x 300mm

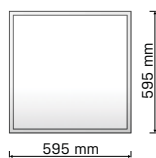

MATRIX 600mm x 600mm



Pannello



STANDARDS



The PANNELLO is a Tritone LED Troffer which comes standard with quadruple power selection, it also has selectable colour temperature. With flicker-free technology, it is available with (or without) air return panels.

- Tritone selectable - 3000K, 4000K, 5000K
- Quadruple power selection 26/32/36/40W
- Flicker-free Technology
- Low glare fitting with UGR<19
- White powder coated aluminium frame
- Designed to be used in T-BAR grid suspended ceilings

SPECIFICATIONS

PANNELLO

	POWER SETTING				CCT	EFFICACY
	40W	36W	32W	26W		
LUMEN OUTPUT	3820lm	3630lm	3330lm	2760lm	3000K	up to 112lm/W
	4090lm	3900lm	3560lm	2910lm	4000K	
	3950lm	3810lm	3470lm	2870lm	5000K	

PANNELLO

MODEL LIST					
FEATURE	POWER SETTING	WEIGHT	SIZE	SAP CODE	PRODUCT CODE
Without Air Return	40 / 36 / 32 / 26W	3.00kg	1220mm	2001975	PANNELLO-LV
With Air Return		3.10kg	1220mm	2001976	PANNELLO-LV-AR

APPLICATIONS

- Offices
- Retail
- Classrooms
- Healthcare

COLOURS



LIGHT OPTICS



Low glare fitting with
UGR<19

DIAGRAMS

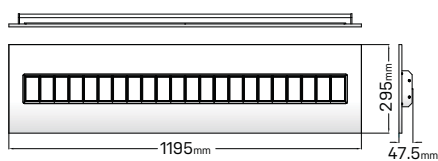

PANNELLO Without
Air Return

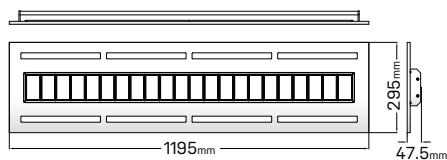

PANNELLO With
Air Return



Galaxy

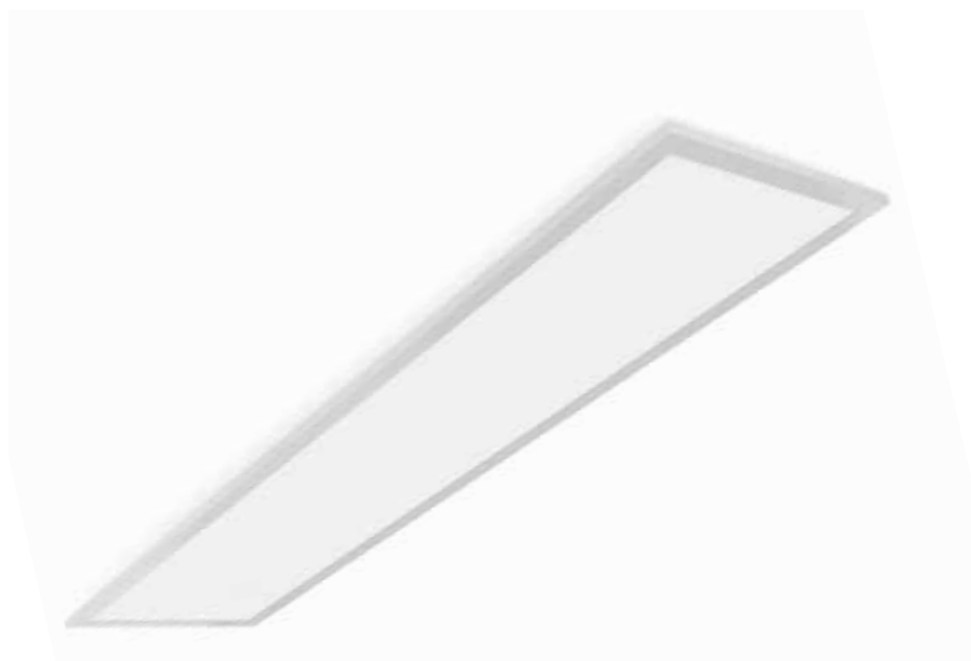

STANDARDS



The GALAXY LED panel is designed to be low profile with excellent light distribution and superior efficacy. Suitable for general illumination in commercial applications, it also meets energy rebate scheme requirements. It is available in recessed or surface mounted options in the following sizes: 300 x 300mm (17W) or 300 x 1200mm (25W).

- Available in 4000K or 5000K
- Recessed and surface mounted option
- Complete with remote control gear
- Optional dimmable driver
- Complete with flex and plug for simple installation

SPECIFICATIONS

GALAXY

POWER	LUMEN	lm/W	CCT	WEIGHT	SAP CODE	PRODUCT CODE
17W	1430 lm	85 lm/W	5000K	0.90 kg	2000602	GALAXY0303-5K
25W	3060 lm	122 lm/W	4000K	3.50 kg	2001854	GALAXY25W0312-4K
	3150 lm	126 lm/W	5000K		2001855	GALAXY25W0312-5K

APPLICATIONS

- Offices
- Commercial
- Colleges, Schools
- Residential
- Industrial

COLOURS



LIGHT OPTICS



Cut off at 120 degrees.

DIAGRAMS

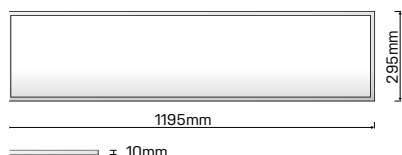

GALAXY 25W

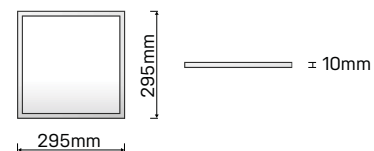

GALAXY 18W



SURFACE MOUNT FRAME

One piece easy surface mount white frame - made of solid steel

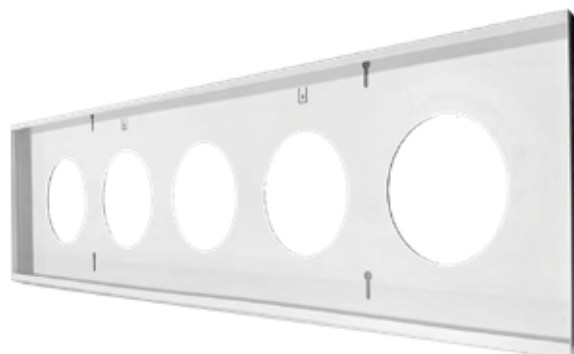

FEATURES	DIMENSIONS	SAP CODE	PRODUCT CODE
Sturdy single piece frame	1275 x 340 x 52mm	2001881	SMPF0312-OP-V2
Self assemble frame	300 x 300 x 60mm	2000404	SMPF0303
	300 x 1200 x 60mm	2000406	SMPF0312

VENTED RECESSED MOUNT FRAME

One piece powder coated white aluminium frame - easy mount with vents (for grid or T-bar ceilings)



FEATURES	DIMENSIONS	SAP CODE	PRODUCT CODE
Sturdy single piece frame	330 x 330 x 41mm	2000356	RLRF0303
	330 x 1230 x 41mm	2000358	PLRF0312
Vented frame	395 x 1195 x 37mm	2001091	RF0412-AF
	595 x 1195 x 37mm	2000410	RF0612-AF

RECESSED MOUNT FRAME

One piece powder coated white aluminium frame



SUITS	DIMENSIONS	SAP CODE	PRODUCT CODE
GALAXY0303 (300 x 300mm)	330 x 330mm	2000356	PLRF0303
GALAXY25W0312 (300 x 1200mm)	330 x 1230mm	2000358	PLRF0312

SUSPENSION KIT

Steel wire cables



FEATURES	DIMENSIONS	SAP CODE	PRODUCT CODE
Steel wire	1m	2001233	PSSKIT-1M-6PCS
	2m	2001234	PSSKIT-2M-6PCS

Highbay

Industrial range

Highbays are an energy efficient, industrial lighting application used for higher ceiling heights with a wider spread of light.



*Featured:
HOODIE LED highbay*





Skylux G2

STANDARDS



The SKYLUX G2 highbay light features effective fin design that optimised heat dissipation to ensure long LED life. It can be fitted with sensors to ensure efficient operation for a variety of applications. With an optional lens attachment the light is delivered to where it is needed.

Robust, with a touch of streamlined elegance, the SKYLUX G2 delivers in both form and function.

- 0-10V dimmable driver with 100-240V a.c. input range
- Robust powder coated aluminium body
- Excellent luminous efficacy of 150lm/W
- Optional DALI convertor available
- Optional quick-connect microwave motion sensor available with configuration remote control
- 1.5m flex and plug provided for simple installation
- Various accessories available

SPECIFICATIONS

SKYLUX G2

POWER	LUMEN	lm/W	CCT	WEIGHT	SAP CODE	PRODUCT CODE
75W 80W 100W 120W	11250lm 12000lm 15000lm 18000lm	150lm/W	5000K	3.00kg	2002090	SKYLUX120W-G2
130W 150W 170W 200W	19000lm 22000lm 25000lm 30000lm	150lm/W	5000K	4.00kg	2002091	SKYLUX200W-G2

APPLICATIONS

- Warehouses
- Factories

COLOURS



LIGHT OPTICS

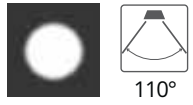

Cut off at 110 degrees.

DIAGRAMS

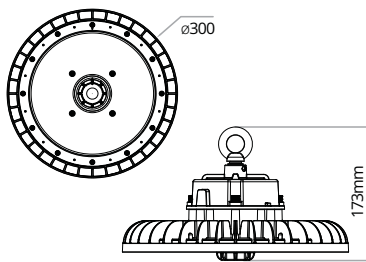

SKYLUX 120W

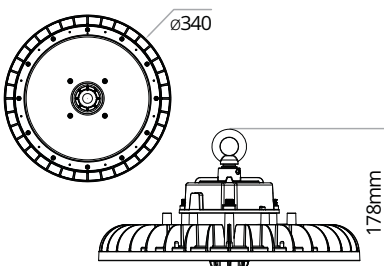

SKYLUX 200W



Skylux plus

STANDARDS



The SKYLUX PLUS is highly efficient and delivers an efficacy of 190lm/W to maximized energy savings. It can be fitted with sensors to ensure efficient operation for a variety of applications. With an optional lens attachment the light is delivered to where it is needed. Robust, with a touch of streamlined elegance, the SKYLUX PLUS delivers in both form and function.

- High luminous efficacy 190lm/W
- 0-10V dimmable driver with 100-240V a.c. input range
- Robust powder coated aluminium body
- Excellent luminous efficacy of 150lm/W
- Optional DALI convertor available
- Optional quick-connect microwave motion sensor available with configuration remote control
- 1.5m flex and plug provided for simple installation

SPECIFICATIONS

SKYLUX PLUS

POWER	LUMEN	lm/W	CCT	WEIGHT	SAP CODE	PRODUCT CODE
75W 80W 100W 120W	14000lm 15000lm 19000lm 22800lm	190lm/W	5000K	3.00kg	2002093	SKYLUX120W-PL
130W 150W 170W 200W	24000lm 28000lm 32000lm 38000lm	190lm/W	5000K	4.00kg	Coming Soon	SKYLUX200W-PL

APPLICATIONS

- Warehouses
- Factories

COLOURS



LIGHT OPTICS

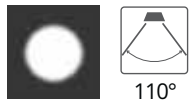

Cut off at 110 degrees.

DIAGRAMS

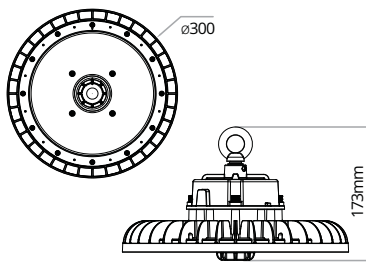

SKYLUX 120W

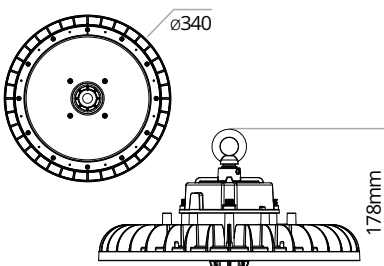

SKYLUX 200W



Skylux

Accessories Specifications

SKYLUX SENSOR

Microwave Motion Sensor



SKYLUX CONTROL

Sensor Remote Control



PRODUCT NAME	Microwave Motion Sensor
FEATURES	Quick-connect with corridor function
SAP CODE	2001899
PRODUCT CODE	SKYLUX-MS

PRODUCT NAME	Sensor Remote Controller
FEATURES	Configures microwave motion sensor
SAP CODE	2001901
PRODUCT CODE	SKYLUX-MS

SKYLUX CONVERTER

Highbay DALI Converter



PRODUCT NAME	FEATURES	SAP CODE	PRODUCT CODE
Highbay DALI Converter	Converting SKYLUX and ARIS to be DALI dimmable (IP65 rated)	2002095	HBAY-DALI-CONV

SKYLUX BRACKET

Surface Mount Bracket



PRODUCT NAME	FEATURES	SAP CODE	PRODUCT CODE
Surface Mount Bracket	Matte black steel	2001902	SKYLUX-BRACKET

SKYLUX LENS

Low Glare Lens



PRODUCT NAME	FEATURES	COMPATIBLE	SAP CODE	PRODUCT CODE
90° Low Glare Lens	Improves glare & beam	120W 200W	2002006 2001906	SKYLUX-90DIF-S SKYLUX-90DIF-M

PRISMATIC DIFFUSER

Tough polycarbonate prismatic diffuser



PRODUCT NAME	FEATURES	SAP CODE	PRODUCT CODE
Polycarbonate Prismatic Diffuser	Prismatic diffuser without cover	2002102 2002103	SKYLUX12G2-PR SKYLUX20G2-PR
	Prismatic diffuser cover	2002104 2002105	SKYLUX12G2-PRC SKYLUX20G2-PRC

METAL REFLECTOR

Robust metal reflector for 70° glare control



PRODUCT NAME	FEATURES	SAP CODE	PRODUCT CODE
70° Metal Reflector	Metal reflector for 70° glare control	2002106 2002107	SKYLUX12G2-RFL SKYLUX20G2-RFL

WIREGUARD

Extra Vandal Protection

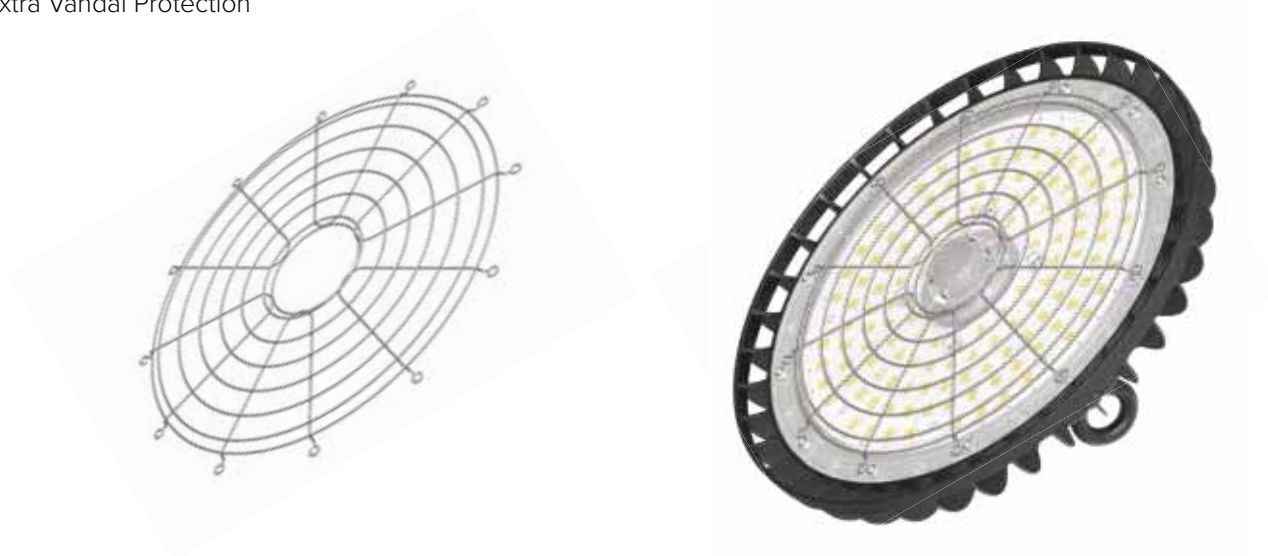

PRODUCT NAME	FEATURES	SAP CODE	PRODUCT CODE
Wireguard	Extra protection to vandal prone applications	2002100 2002101	SKYLUX12G2-WG SKYLUX20G2-WG

INSTALLATION SAFETY

Varies accessories for safety installation

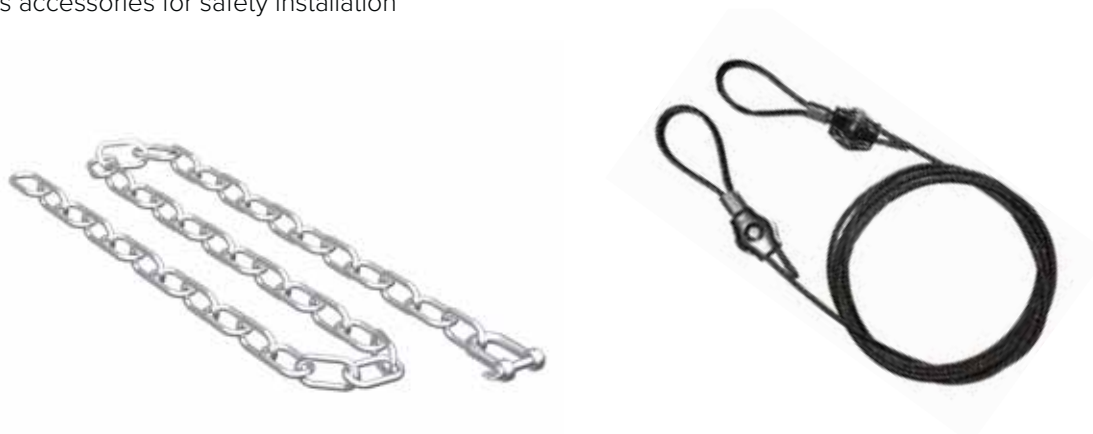

PRODUCT NAME	FEATURES	SAP CODE	PRODUCT CODE
Stainless steel chain Safety rope	Extra protection for installation security	2001900 2001903	SKYLUX-CHAIN SKYLUX-ROPE

Skypad



STANDARDS

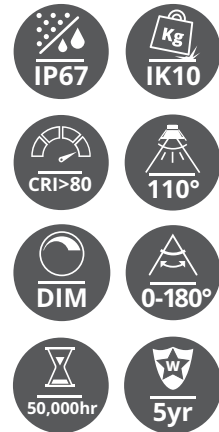

The SKYPAD is a powerful, cost effective and adaptable solution for lighting large industrial spaces. It comes in a range of wattages with accessories including diffusers, wire guards and brackets that allow 90° mounting.

- 110° beam angle or 90° with aluminium reflector
- Black powder coated diecast aluminium body
- Available wattages: 120W, 150W and 200W
- 2.5m UV resistant flex and plug included
- Intellisensor motion sensor and Sunmax daylight sensor available
- Also compatible with KASTA Bluetooth Wireless Daylight Sensor and dimming system

SPECIFICATIONS

SKYPAD

POWER	LUMEN	lm/W	CCT	WEIGHT	SAP CODE	PRODUCT CODE
120W	17320lm	144lm/W	5000K	4.00kg	2000881	SKYPAD120W-10VDIM
150W	21000lm	140lm/W	5000K	4.00kg	2000390	SKYPAD150W-10VDIM
200W	28000lm	140lm/W	5000K	5.50kg	2000908	SKYPAD200W-V2

APPLICATIONS

- Commercial
- Industrial
- Warehousing (best suited for mounting heights above 5m)

COLOURS



LIGHT OPTICS

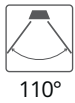

Cut off at 110 degrees.

DIAGRAMS

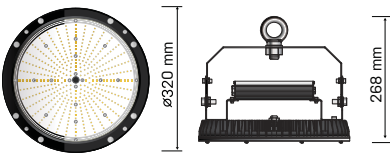

SKYPAD 120W / 150W

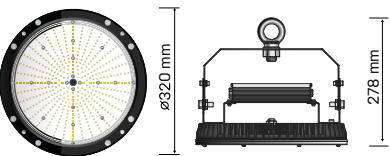

SKYPAD 200W



PRISMATIC REFLECTOR

Tough Polycarbonate Diffuser



PRODUCT NAME	FEATURES	SAP CODE	PRODUCT CODE
Polycarbonate Prismatic Diffuser	Open prismatic reflector	2000396	SKYPAD-PRSDIF
	Enclosed prismatic reflector	2000827	SKYPAD-PRSDIF-EN

METAL REFLECTOR

Robust metal reflector for 90° glare control



PRODUCT NAME	FEATURES	SAP CODE	PRODUCT CODE
90° Metal Reflector	Metal reflector for 90° glare control	2000292	HRPAD90DB

EXTENSION BRACKET

Surface Mount Bracket



PRODUCT NAME	FEATURES	SAP CODE	PRODUCT CODE
Extension Bracket	For different mounting options up to 90°	2000196	FL-SKYPADKIT

FOOD SAFE MOUNT

Surface Mount Kit



PRODUCT NAME	FEATURES	SAP CODE	PRODUCT CODE
Surface Mount Kit	Suitable for hospitality and food processing industries	2000395	SKYPAD-FGSMK001

OPAL DIFFUSER

Tough Polycarbonate Diffuser



PRODUCT NAME	FEATURES	SAP CODE	PRODUCT CODE
Polycarbonate Diffuser	Tough opal polycarbonate diffuser for glare reduction	2000350	PCD-SKYPAD

WIREGUARD

Extra Vandal Protection

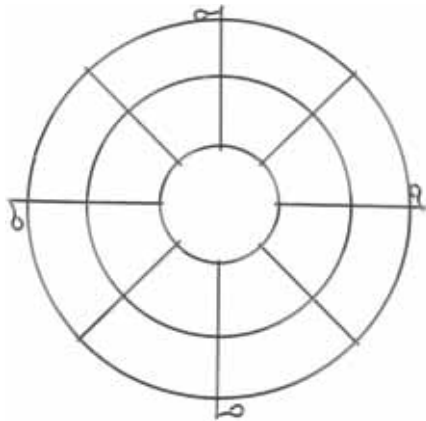

PRODUCT NAME	FEATURES	SAP CODE	PRODUCT CODE
Wireguard	Extra protection to vandal prone applications	2000399	SKYPAD-WIREGUARD



SUNMAX SMART CONTROL

Microwave Motion Sensor



PRODUCT NAME	FEATURES	SAP CODE	PRODUCT CODE
SUNMAX Smart Control	Daylight sensor with smart control. Ideal for daylight harvesting applications	2000878	SUNMAX50MA-W-IP20
BRACKET	Matte black steel	2000891	SUNMAX-BRKT

INTELLESENSOR

Smart Control



PRODUCT NAME	FEATURES	SAP CODE	PRODUCT CODE
INTELLESENSOR Smart Control	<ul style="list-style-type: none"> • Microwave motion sensor • Corridor function (low level comfort lighting when no presence is detected. Turns on to full brightness when presence is detected.) • Energy efficient <i>(See page 191 for application diagram)</i>	2002011	MC054V-WIRELESS
Remote Control	Easily reprogram intellisensor with this wireless remote	4000378	MC054V-REMOTE

SUNMAX APPLICATION DIAGRAM

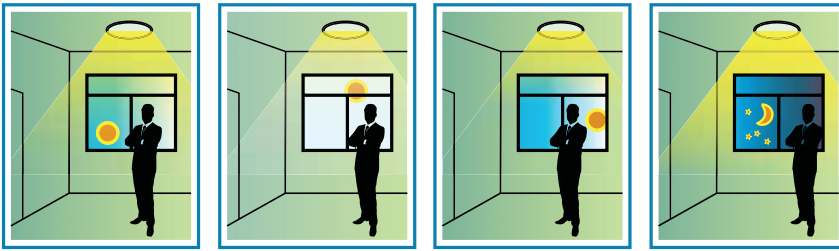

The lamp lights on 100% illumination or dims to maintain the preset illumination level against ambient light.

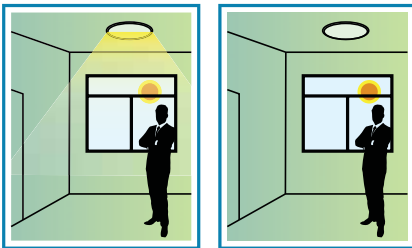

The lamp dims to minimum light level but never turn off even if with sufficient ambient light.



Users can switch the light off manually as required.

INTELLISENSOR APPLICATION DIAGRAM

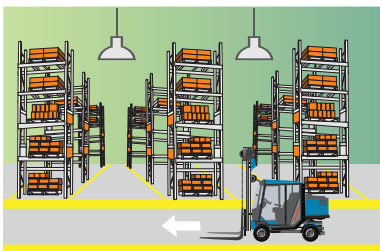

With sufficient ambient light, the sensor does not switch on the lamp.

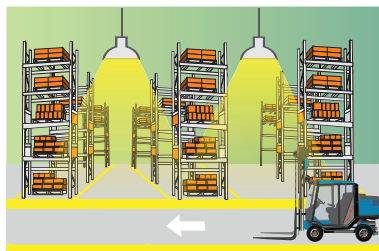

With sufficient ambient light, the sensor switches on the lamp when motion is detected.

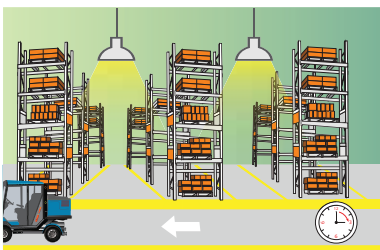

After hold time, the sensor dims the lamp at a low level if no new motion trigger.

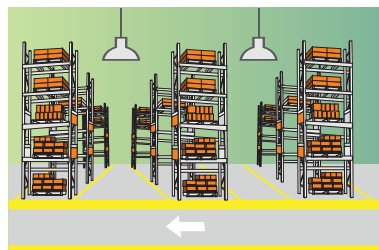

After stand-by period, the sensor switches off the lamp if no motion is detected in its detection zone.

KASTA 1-10V DIMMER

Wireless Dimming



PRODUCT NAME	FEATURES	SAP CODE	PRODUCT CODE
KASTA 1-10V Dimmer	Wireless dimming control perfect for large spaces	5000012	D1-10VIBH

KASTA DAYLIGHT SENSOR

Used with KASTA 1-10V Dimmer



PRODUCT NAME	FEATURES	SAP CODE	PRODUCT CODE
KASTA Daylight Sensor	Used with 1-10V dimmer for daylight harvesting	5000011	SL02AB-BH

KASTA.COM.AU

KASTA 1-10V DIMMER APPLICATION DIAGRAM

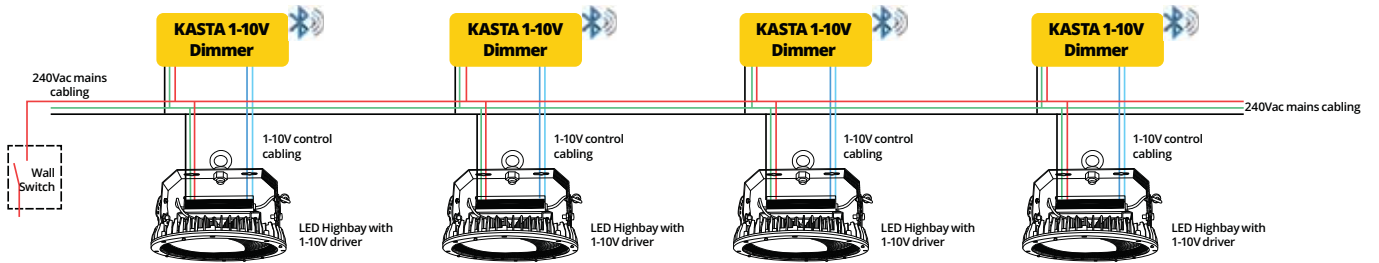

KASTA DAYLIGHT SENSOR APPLICATION DIAGRAM

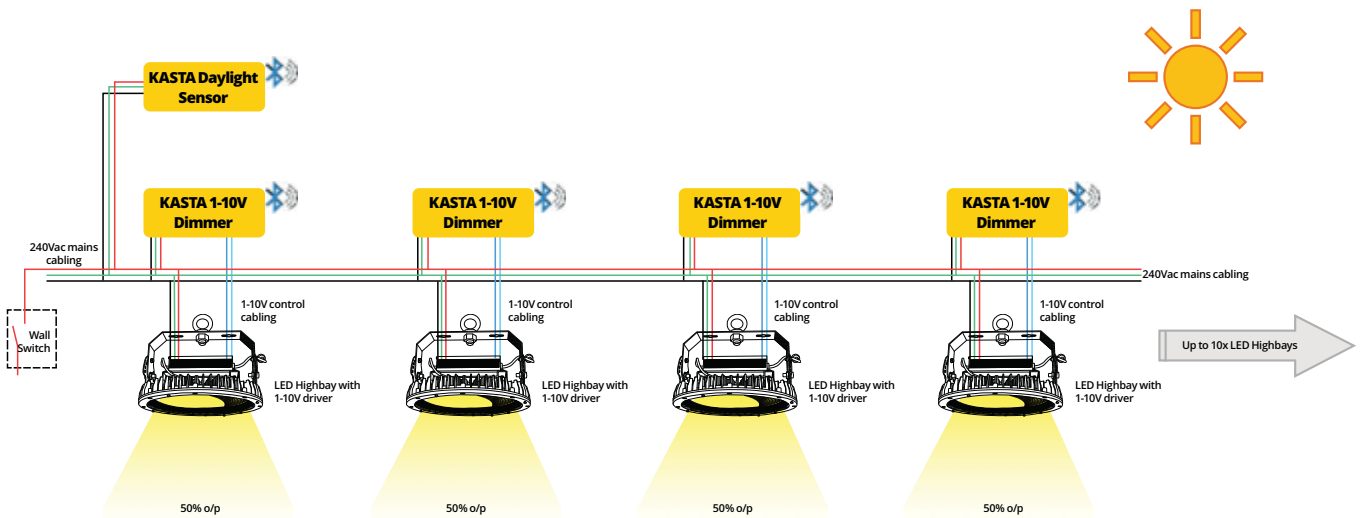

KASTA.COM.AU



HIGHBAY LIGHTING



Hoodie

STANDARDS

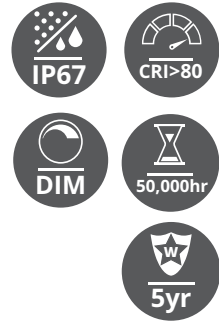

The HOODIE features excellent luminous efficacy, compactness and aesthetically pleasing design which is ideal for large retail complex and industrial applications. It is also ideal for outdoor applications such as apartments, schools and public areas.

- Robust powder coated aluminium body
- Large terminal block for easy installation
- IP66 Ingress protection & IK10 Impact ratings
- UV Stabilised polycarbonate diffuser

SPECIFICATIONS

HOODIE

POWER	LUMEN	lm/W	CCT	WEIGHT	SAP CODE	PRODUCT CODE
120W	16840lm	140lm/W	5000K	5.75kg	2001239	HOODIE120W70D

APPLICATIONS

- Retail
- Hospitality
- Architectural

COLOURS



LIGHT OPTICS

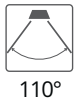

Cut off at 110 degrees.

DIAGRAMS

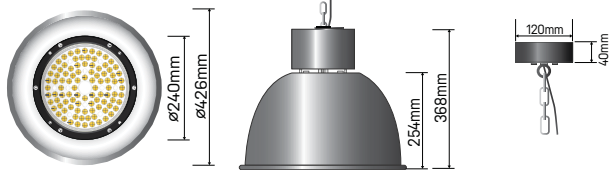



Aris

STANDARDS

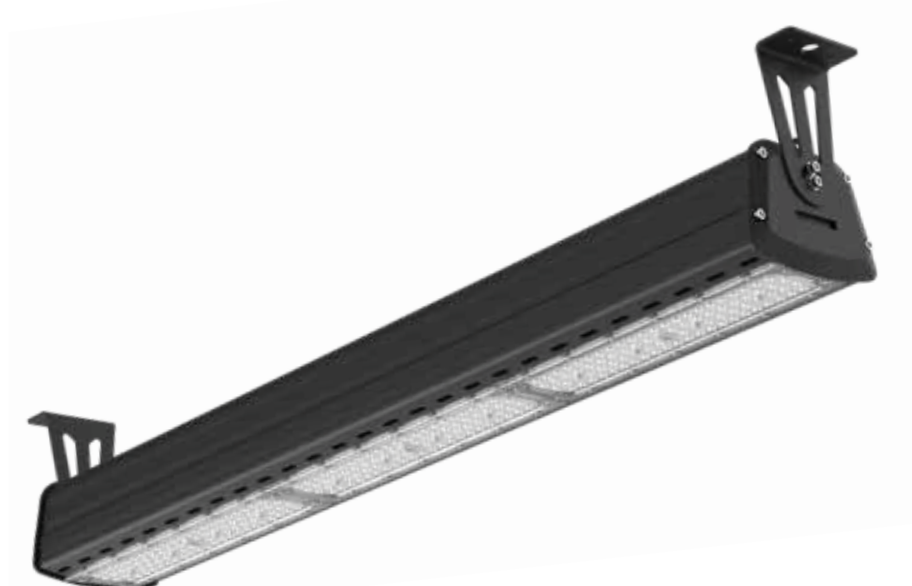

The ARIS is a series of waterproof sleek appearance Linear LED Highbays that are complete with an asymmetric lens and 0-10V dimmable integral driver. This vandal resistant 5000K fitting has dedicated CRI80 chips. The clear lens offers more reliable and consistent CCT with great performance.

- Aluminium body linear LED highbay
- Available in both 150W and 200W
- Surface mount or suspended mount
- Asymmetric light pattern with minimal light loss
- Choice of beam angles - 40°x120° for wide aisles and 30°x70° for narrow aisles
- Optional DALI convertor and daylight/motion sensor available, optional suspension kit

SPECIFICATIONS

ARIS

POWER	BEAM ANGLE	LUMEN	lm/W	CCT	WEIGHT	SAP CODE	PRODUCT CODE
150W	30°x70° High Mount	18630lm	124lm/W	5000K	3.50kg	2002031	ARIS150W30x70
	40°x120° Low Mount	18740lm	125lm/W			2002032	ARIS150W40x120
200W	30°x70° High Mount	24880lm	124lm/W		4.10kg	2002033	ARIS200W30x70
	40°x120° Low Mount	24910lm	125lm/W			2002034	ARIS200W40x120

APPLICATIONS

- Warehouses
- Factories
- Petrol stations
- Railway stations
- Overpasses
- Airports
- Other large areas

COLOURS



LIGHT OPTICS



Cut off at 40°x120° for wide aisles and 30°x70° for narrow aisles

DIAGRAMS

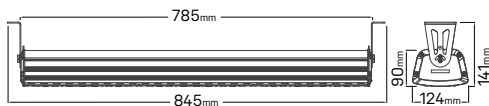

ARIS 150W

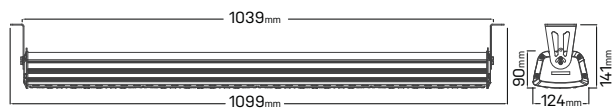

ARIS 200W



ARIS SENSOR

Daylight Microwave Sensor



PRODUCT NAME	FEATURES	SAP CODE	PRODUCT CODE
ARIS Sensor	Daylight / microwave sensor	2002035	ARIS-SENSOR

ARIS CONTROL

* Can be used with SKYLUX

Sensor Remote Control

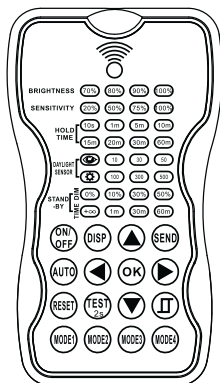

PRODUCT NAME	FEATURES	SAP CODE	PRODUCT CODE
Sensor Remote Controller	Configures microwave motion sensor	2001901	SKYLUX-REMOTE

ARIS SUSPENSION KIT

Steel Wire Suspension Kit

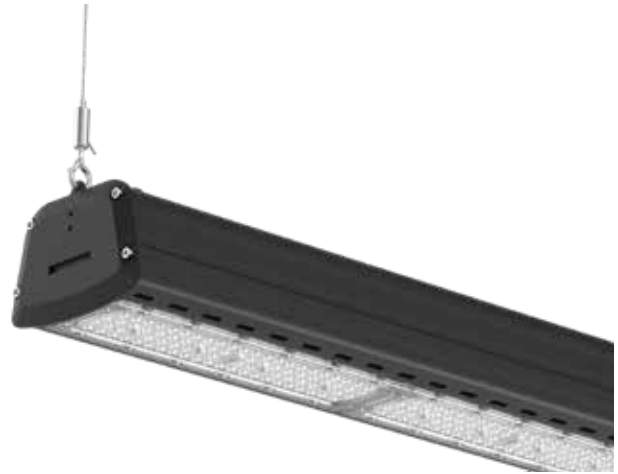

PRODUCT NAME	FEATURES	SAP CODE	PRODUCT CODE
ARIS Suspension kit	Can withstand four times of its own weight	2002068	ARIS-SUSKIT

ARIS BRACKET

Surface mount brackets (Supplied as standard)



A GUIDE TO WAREHOUSE LIGHTING

For warehouse lighting the Australian Standards AS/NZ1680.2.4 recommends the following **maintained average** lux levels.

Storage of goods of different kinds and search and retrieval tasks = **Av 80 lux**.

Storage routinely involving reading tasks = **Av 160 lux**.

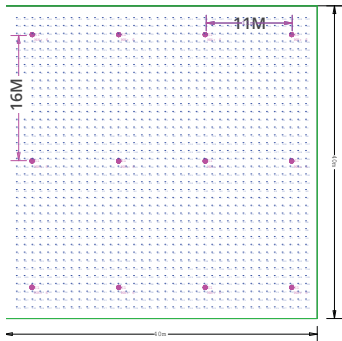

Hm = 6m
SKYPAD 120W

AV 92 lux
Uf = 0.51
Mf = 0.8



Hm = 10m
SKYPAD 150W

AV 102 lux
Uf = 0.74
Mf = 0.8

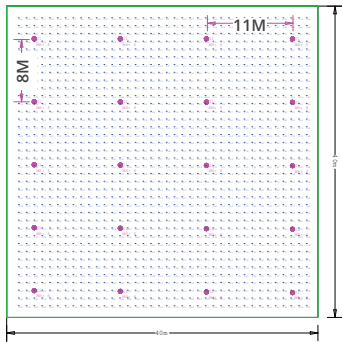

Hm = 6m
SKYPAD 120W

AV 160 lux
Uf = 0.6
Mf = 0.8

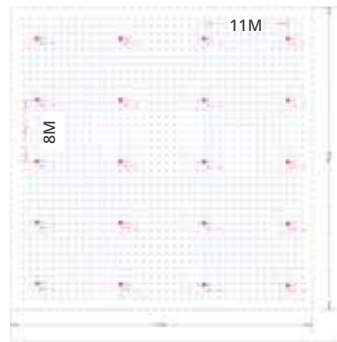

Hm = 10m
SKYPAD 150W

AV 178 lux
Uf = 0.66
Mf = 0.8

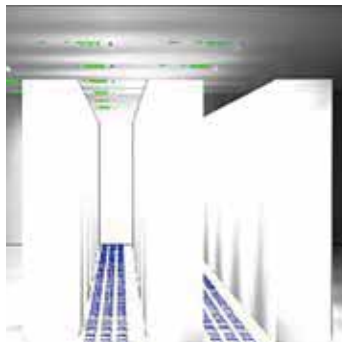

7.3M Spacing
2M

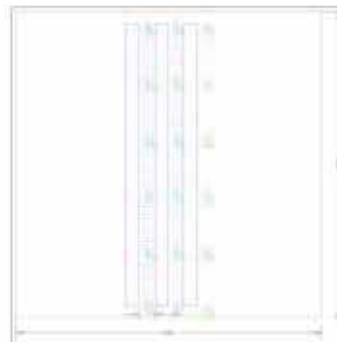

Hm = 10m
MERIDIAN 160W

AV 258 lux
Uf = 0.5
Mf = 0.8

ADDITIONAL OPTIONS TO CONSIDER

Sunmax smart control

The installation of a Sunmax which controls light levels depending on daylight can be a convenient option for warehouse lighting. If the warehouse receives natural light in some areas it may be appropriate to reduce the intensity of the lighting in those areas.

This would significantly minimise energy costs. Refer p190 for more product information.

Intellisensor smart control

In warehouse spaces where there is no activity, there is no need to keep lights on constantly. A convenient way to keep energy costs down is to utilize motion sensors. Motion sensors serve to coordinate the diffusion of light based on occupancy in various areas of the warehouse. Refer p190 for product information.



Lowbay

Industrial range

Lowbays are designed for industrial applications where the ceiling is a lower height and a narrow beam angle is required.



*Featured:
BENZINA lowbay*





Benzina



STANDARDS



The BENZINA is a versatile LED Canopy Light ideal for service stations, bus stations, drive-throughs, shopping centres and other large, covered areas. The BENZINA has clean architectural lines and delivers optimum illumination which provides enhanced safety or security at night.

- IP65 waterproof and IK08 impact protected
- Polymer coating suitable for damp areas
- Rugged, corrosion resistant aluminium body
- Glass lens cover and white gloss powder coat
- 1-10V dimmable, 130lm/W high output
- Various mounting accessories available

SPECIFICATIONS

BENZINA

POWER	FEATURE	LUMEN	CCT	WEIGHT	SAP CODE	PRODUCT CODE
100W	Frosted glass diffuser	13300lm	5000K	5.4kg	2002062	BEN100W-5K
150W		19320lm			2002063	BEN150W-5K

APPLICATIONS

- Service, Bus and Transit Stations
- Drive-throughs
- Shopping Centres
- Car Washes
- Vehicle Weigh Stations

COLOURS



LIGHT OPTICS



Cut off at 110 degrees.

DIAGRAMS

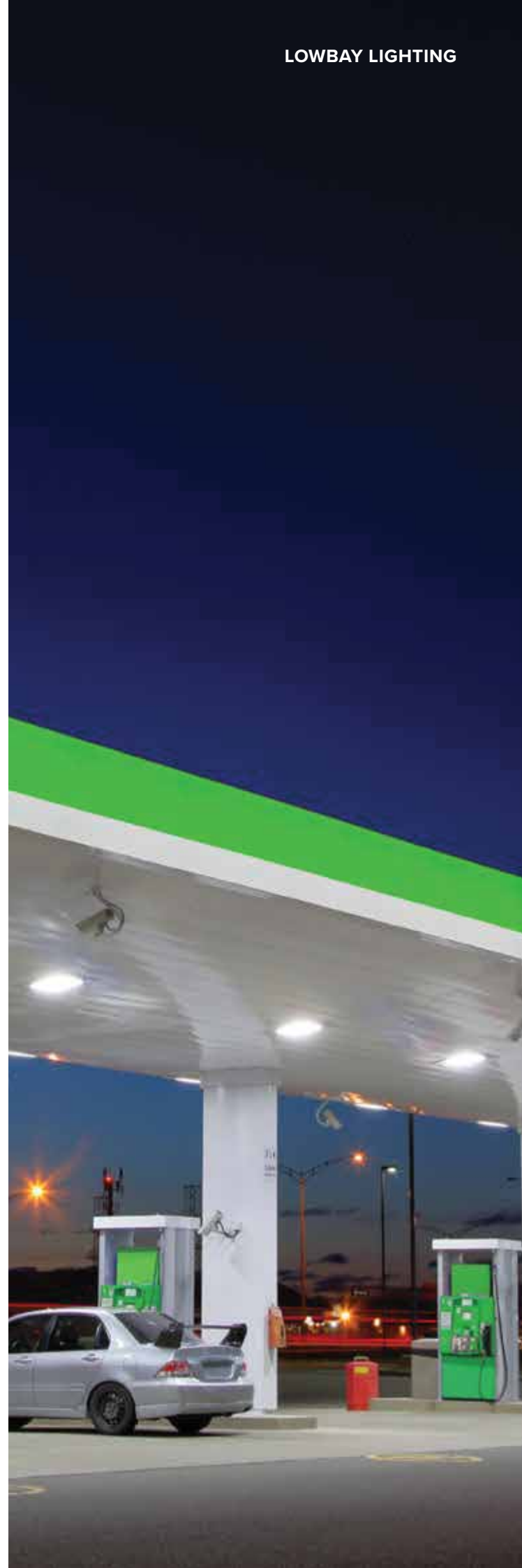
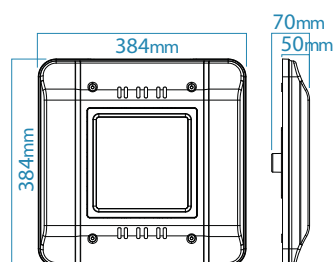

Skycube

STANDARDS



The SKYCUBE lowbay LED light is an energy efficient economical alternative to conventional lowbay lighting. An IP65 rating and HACCP Food Grade approval it is highly suitable for Commercial Kitchens.

- Significantly reduces costs compared to metal halide
- Opal lens for reduced glare and diffused light
- Available in two wattages: 120W and 180W
- Surface mount installation
- Great moisture and dust protection
- Sturdy IK09 impact rating

SPECIFICATIONS

SKYCUBE

POWER	FEATURE	LUMEN	lm/W	CCT	WEIGHT	SAP CODE	PRODUCT CODE
120W	Clear diffuser	12400 lm	103 lm/W	5000K	6.00 kg	2000380	SKYCUBE120W-IP65
180W		19190 lm	107 lm/W		7.90 kg	2000381	SKYCUBE180W
		18160 lm	101 lm/W		2000656	SKYCUBE180W-OP	

APPLICATIONS

- Storerooms
- Workshops
- Warehouses
- Commercial kitchens

COLOURS



LIGHT OPTICS

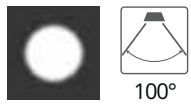

Cut off at 100 degrees.

DIAGRAMS

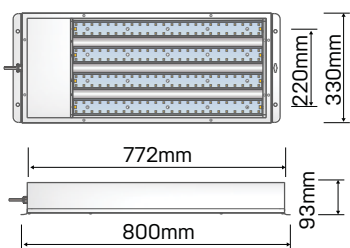

Exterior

Exterior lighting

Exterior lighting can be used for a variety of applications including entrances and larger areas with a need for security lighting or safety. Our range of floodlights suit sporting fields or car parks beautifully.



*Featured:
ARCHISPOT silver*





FLOODLIGHTS



Stax^{Eco}



STANDARDS



The STAX ECO is the next generation in our versatile and efficient LED floodlight range. With a range of power from 20W to 200W it is excellent for a wide number of applications. It also has an optional PIR motion sensor for added security.

- Easily adjustable lighting direction
- PIR motion sensor available for 20-100W models
- IP66 weather resistant housing
- Compact design to suit many applications
- Increased energy efficient LED technology
- Corner mounting option available

SPECIFICATIONS

STAX ECO

POWER	LUMEN	lm/W	CCT	WEIGHT	SAP CODE	PRODUCT CODE
20W	2000lm			0.6kg	2002128	STAX20W4K
30W	3000lm			0.6kg	2002129	STAX30W4K
100W	10000lm	100lm/W	4000K	1.8kg	2002132	STAX100W4K
150W	15000lm			2.4kg	2002133	STAX150W4K
200W	20000lm			2.8kg	2002134	STAX200W4K

APPLICATIONS

- Residential
- Colleges, Schools
- Retail
- Factories
- Public Areas

LIGHT OPTICS

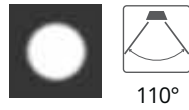

110°

Cut off at 110 degrees.

COLOUR AND VARIANTS



BLACK



MOTION SENSOR
STAX-SENSOR
(20-100W Models only)



CORNER MOUNT BRACKET
STAX90D-BRKT-S
STAX90D-BRKT-L

DIAGRAMS

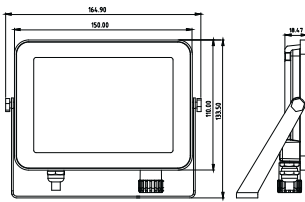

STAX20W4K / STAX30W4K

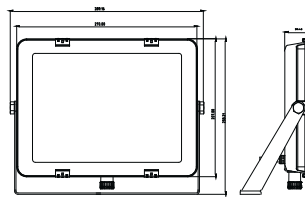

STAX100W4K

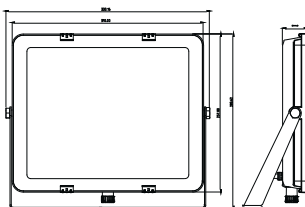

STAX150W4K

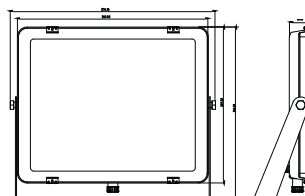

STAX200W4K





Stax Eco Multi



STANDARDS



The STAX ECO MULTI is a versatile and efficient LED Floodlight. With switchable temperature and dual power versions it also has an optional PIR motion sensor available, making it suitable for a wide range of applications.

- Easily switchable colour temperature
- Versatile power switchable version 15W / 30W
- Easily adjustable lighting direction
- PIR motion sensor available
- IP66 weather resistant housing
- Corner mounting option available

SPECIFICATIONS

STAX ECO MULTI

POWER	LUMEN	lm/W	CCT	WEIGHT	SAP CODE	PRODUCT CODE
15W 30W	1500lm 3000lm	100lm/W	4000K 5000K 6000K	0.6kg	2002130	STAX15W30W-TRI
50W	5000lm			1.2kg	2002131	STAX50W-TRI

APPLICATIONS

- Residential
- Colleges, Schools
- Retails
- Factories
- Public Areas

LIGHT OPTICS

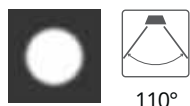

110°

Cut off at 110 degrees.

COLOUR AND VARIANTS



BLACK



MOTION SENSOR
STAX-SENSOR



CORNER MOUNT BRACKET
STAX90D-BRKT-S

DIAGRAMS

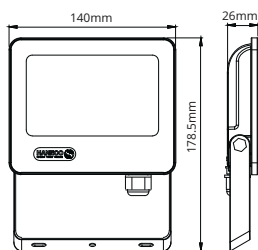

STAX15W30W-TRI

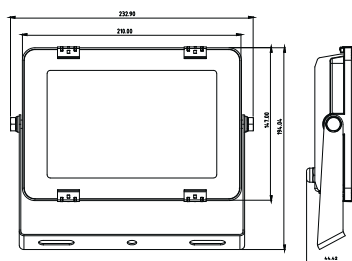

STAX50WTRI



Parx



STANDARDS



The PARX is a super bright industrial LED floodlight. It is easily installed and comes with a range of accessories for mounting and protection. The asymmetrical lens allows much less spill than a standard lens which makes aiming from elevated angles much easier.

- Trunnion bracket allows adjustment of light direction
- Wall mount & pole mount options
- Available in 150W, 200W and 300W
- High performance floodlight
- Asymmetric distribution
- Mercury free, glass free and non-toxic

SPECIFICATIONS

PARX

PIR MOTION SENSOR

BEAM	POWER	LUMEN	lm/W	CCT	WEIGHT	SAP CODE	PRODUCT CODE
100° x 66°	150W	20090lm	133lm/W	5000K	7.80kg	2000886	PARX150W-ASYM
	200W	24710lm	124lm/W			2000851	PARX200W-ASYM
120° x 60°	300W	39280lm	131lm/W			2001092	PARX300W-ASYM

APPLICATIONS

- Recreational sports lighting
- Area lighting
- Car parks

COLOURS



LIGHT OPTICS

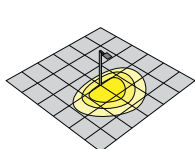

120°x60°

Cut off at 120°x60° degrees.

DIAGRAMS

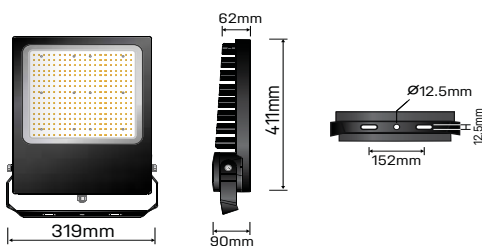

GLARE SHIELD

Reduces unwanted glare



PRODUCT NAME	FEATURES	SAP CODE	PRODUCT CODE
320 x 275 x 120mm	Powder coated STEEL	2000485	PARX-GS

WIRE GUARD

Protect lens



PRODUCT NAME	FEATURES	SAP CODE	PRODUCT CODE
340 x 290 x 60mm	Powder coated STEEL	2000487	PARX-WG

TENON MOUNT

Top mount bracket



PRODUCT NAME	FEATURES	SAP CODE	PRODUCT CODE
322 x 230 x 96mm	Powder coated STEEL	2000675	PARX-TENON

POLE MOUNT

Side mount bracket



PRODUCT NAME	FEATURES	SAP CODE	PRODUCT CODE
322 x 205 x 62mm	Powder coated STEEL	2000486	PARX-POLEM

Panorama

STANDARDS



The PANORAMA is a series of Tritone LED security lights for residential applications with a choice of black or white finishes. The body of the PANORAMA is manufactured from a high UV rated polycarbonate material that allows it to be exposed to direct sunlight. Its modern look and flexible sensor settings will add great value to dwellings.

- Tritone selectable - 3000K, 4000K, 5000K
- Fully adjustable lamp position
- PIR motion sensor version available
- Stylish white and black finishes available
- Quick plug-on base for easy installation
- High UV rated polycarbonate material

SPECIFICATIONS

PANORAMA Non-sensor models

POWER	FEATURE	LUMEN	lm/W	CCT	WEIGHT	SAP CODE	PRODUCT CODE
10W	Single Head Black	790lm	79lm/W	3000K	0.34kg	2001948	PANORAMA10W
	Single Head White	910lm	91lm/W	4000K		2001965	PANORAMA10W-W
20W	Twin Head Black	1570lm	78lm/W	3000K	0.49kg	2001950	PANORAMA20W
	Twin Head White	1750lm	88lm/W	4000K		2001967	PANORAMA20W-W

PANORAMA Sensor models

POWER	FEATURE	LUMEN	lm/W	CCT	WEIGHT	SAP CODE	PRODUCT CODE
10W	Single Head Black with Sensor	790lm	79lm/W	3000K	0.35kg	2001949	PANORAMA10WS
	Single Head White with Sensor	910lm	91lm/W	4000K		2001966	PANORAMA10WS-W
20W	Twin Head Black with Sensor	1570lm	78lm/W	3000K	0.49kg	2001951	PANORAMA20WS
	Twin Head White with Sensor	1750lm	88lm/W	4000K		2001968	PANORAMA20WS-W

APPLICATIONS

- Residential
- Car Parks
- Garages
- Gardens
- External Walkways

COLOURS



LIGHT OPTICS



Cut off at 75 degrees.

DIAGRAMS

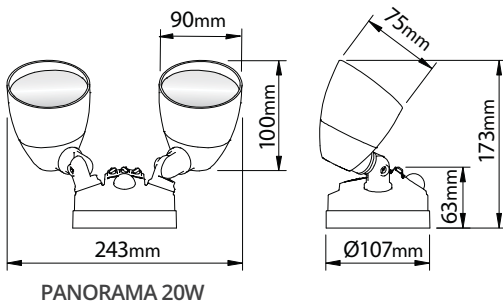
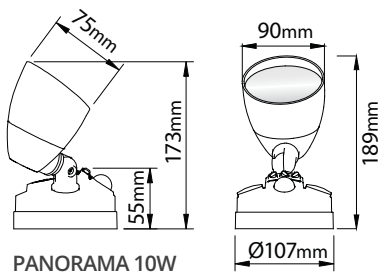

Proxima-tri



STANDARDS



The PROXIMA-TRI is available with single and twin heads (with 15W per head) for general security illumination. The small profile design with optional PIR sensor is ideal for residential and commercial exterior applications such as entrance, driveways and carports.

- Single head – 15W, Double head – 30W
- Fully adjustable lamp position
- Durable aluminium body
- 180° PIR detection coverage available
- Adjustable lighting level sensor
- Accessible rotary switches
- Manual override function
- Plug-on base design

SPECIFICATIONS

PROXIMA-TRI

POWER	COLOUR	LUMEN	lm/W	CCT	WEIGHT	SAP CODE	PRODUCT CODE
15W	Black	1000lm 1100lm	67lm/W 73lm/W	3000K 4000K	0.50kg	2001998	PROXIMA-TRI15
	White	1000lm				2002058	PROXIMA-TRI15-W
30W	Black	2000lm 2200lm	67lm/W	5000K	0.80kg	2002000	PROXIMA-TRI30
	White	2000lm				2002059	PROXIMA-TRI30-W

APPLICATIONS

- Residential
- Car Parks
- Garages
- Gardens
- External Walkways

COLOURS AND VARIANTS



WHITE



BLACK



PROXIMA-PIR-W
SAP CODE 2002060



PROXIMA-PIR-B
SAP CODE 2002061

LIGHT OPTICS



100°

Cut off at 100 degrees.

DIAGRAMS

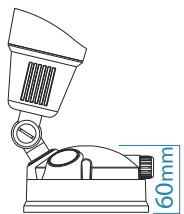

60mm

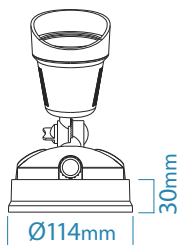

Ø114mm

30mm

PROXIMA-TRI 15W

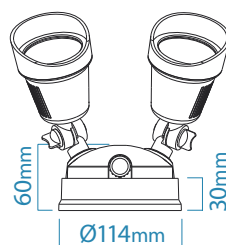

60mm

Ø114mm

30mm

PROXIMA-TRI 30W



BUNKER LIGHTS



Dawn



STANDARDS



The DAWN is a range of LED bunker lights available in either round or oval shape. It has an IP66 rating and is available with eyelid (round) or grille (oval) making it ideal for outdoor applications such as, apartment buildings, schools or public areas.

- Robust powder coated aluminium body
- Tritone selectable - 3000K, 4000K, 5000K
- Large terminal block for easy installation
- UV stabilised polycarbonate diffuser
- IP66 Ingress protection and IK10 Impact ratings
- Emergency (EM) and Microwave sensor (MS) versions available

SPECIFICATIONS

DAWN

POWER	FEATURE	LUMEN	lm/W	CCT	WEIGHT	SAP CODE	PRODUCT CODE
16W	Opal diffuser Oval	1320lm	83lm/W	3000K	0.95kg	2001706	DN16WOVL-TRI
		1500lm	94lm/W	4000K	1.00kg	2001909	DN16WOVL-TRI-MS
		1400lm	88lm/W	5000K			
20W	Opal diffuser Round	2050lm	103lm/W	3000K	1.30kg	2001699	DN20WRND-TRI
		2050lm	103lm/W	4000K	1.30kg	2001910	DN20WRND-TRI-MS
		1890lm	95lm/W	5000K	1.80kg	2001911	DN20WRND-TRI-EM
					1.80kg	2001912	DN20WRND-TRI-MS-EM
					2.30kg	2001700	DN30WRND-TRI
30W	Opal diffuser Round	2760lm	92lm/W	3000K	2.30kg	2001913	DN30WRND-TRI-MS
		3000lm	100lm/W	4000K	2.80kg	2001914	DN30WRND-TRI-EM
		2770lm	92lm/W	5000K	2.80kg	2001915	DN30WRND-TRI-MS-EM

EM (Emergency battery backup) MS (Microwave Sensor)

APPLICATIONS

- Exterior walls
- Under eaves
- Stairs
- Industrial

COLOURS



LIGHT OPTICS

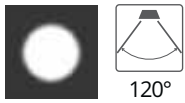

Cut off at 120 degrees.

DIAGRAMS

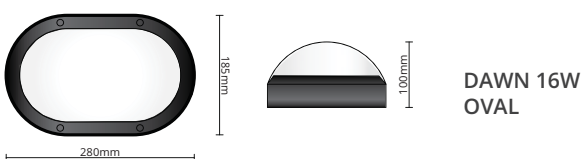



ROUND EYELID

Microwave Motion Sensor



PRODUCT NAME	FEATURES	SAP CODE	PRODUCT CODE
Round eyelid (for 20W only)	270mm trim	2001701	DNRND-EL270

OVAL GRILLE

Low Glare Lens



PRODUCT NAME	FEATURES	SAP CODE	PRODUCT CODE
Oval grille (for 16W only)	280 x 185mm trim	2001709	DNOVL-GR280



Caleo



STANDARDS



The CALEO is an LED outdoor security light that is vandal resistant with a UV stabilised polycarbonate diffuser. The combination of an IP65 rating and microwave sensors makes it suitable for outdoor pathway guidance.

- Wall mounted security/safety LED light
- Robust powder coated aluminium body
- Vandal resistant
- Large terminal block for easy installation
- Model available with an adjustable microwave motion and daylight sensor

SPECIFICATIONS

CALEO

POWER	LUMEN	lm/W	CCT	WEIGHT	SAP CODE	PRODUCT CODE
30W	2290lm	76lm/W	5000K	2.15kg	2000697	CALEO30W-5K
					2000698	CALEO30W-5K-S

APPLICATIONS

- Stairs
- Security lighting
- Driveways
- Industrial exteriors

COLOURS



LIGHT OPTICS

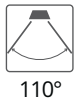

Cut off at 110 degrees.

DIAGRAMS

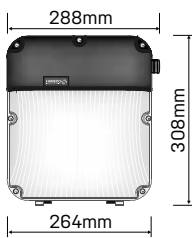

WALL LIGHTS



Archispot



STANDARDS

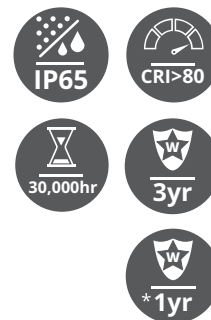

The ARCHISPOT is a decorative wall pillar luminaire providing a contemporary solution for modern exteriors such as porticos and entrances. Also available with an adjustable beam the ARCHISPOT can also provide accent lighting for retail, commercial and residential areas.

- Robust powder coated aluminium body
- Large terminal block for easy installation
- 1x 6W bulb (2x 6W for up/down model)
- Replaceable GU10 LED bulbs
- Fixed, adjustable or up/down configurations
- Available in a black or silver finish

SPECIFICATIONS

ARCHISPOT

POWER	FEATURE	LUMEN	lm/W	CCT	WEIGHT	SAP CODE	PRODUCT CODE
6W	Fixed Black	420lm	70lm/W	3000K	0.40kg	2001817	ASFIX6W60-B-3K
	Fixed Silver				1.00kg	2001477	ASFIX6W60-S-3K
	Adjust Black				0.40kg	2001818	ASADJ6W60-B-3K
	Adjust Silver				1.00kg	2001478	ASADJ6W60-S-3K
12W	Up/Down Black	930lm	78lm/W	3000K	0.65kg	2001538	ASU/D12W60-B-3K
	Up/Down Silver				1.00kg	2001479	ASU/D12W60-S-3K

*1 year guarantee applies to lamp only.

APPLICATIONS

- Entrances
- Porticos
- Exterior walls

COLOURS



SILVER



BLACK



LIGHT OPTICS



Cut off at 35 degrees.

35°

DIAGRAMS

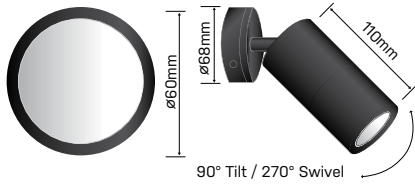

ARCHISPOT
ADJUSTABLE

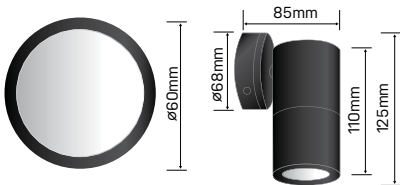

ARCHISPOT
FIXED

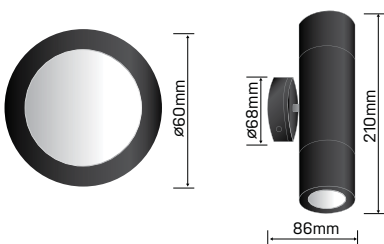

ARCHISPOT
UP/DOWN





Wall Washer



STANDARDS



The WALL WASHER is designed to give excellent optical control, reduce excess light spillage making it an ideal accent lighting luminaire for both interior and exterior applications.

- Balanced vertical illumination
- Clear diffuser on both sides for up/down lighting
- Robust powder coated aluminium body
- Large terminal block for easy installation
- IP54 Ingress protection rating
- Available in white, grey or black finishes

SPECIFICATIONS

WALL WASHER

POWER	FEATURE	LUMEN	lm/W	CCT	WEIGHT	SAP CODE	PRODUCT CODE
12W	White	430lm	36lm/W	3000K	0.80kg	2000551	W12W150*90RE3KW
		460lm	38lm/W	4000K		2000553	W12W150*90RE4KW
		420lm	35lm/W	6000K		2000555	W12W150*90RE6KW
	Grey	430lm	36lm/W	3000K		2000550	W12W150*90RE3KG
		430lm	36lm/W	3000K		2000549	W12W150*90RE3KB
		Black	460lm	38lm/W		4000K	2000552
	420lm		35lm/W	6000K		2000554	W12W150*90RE6KB

APPLICATIONS

- Residential
- Hospitality
- Architectural

COLOURS



LIGHT OPTICS

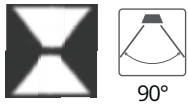

Cut off at 90 degrees.

DIAGRAMS

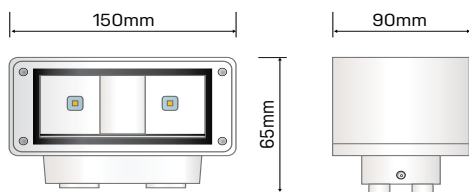

Bollard

Exterior lighting

The LED BOLLARD is an elegant and functional landscape lighting feature used to illuminate and create ambiance in garden, pathways or outdoor settings.



*Featured:
MATITA*





Matita



STANDARDS



The MATITA bollard guides the way with a low glare louvered light. This IP65 rated luminaire is suitable for a range of landscape applications such as driveways, paths, car parks and/or gardens.

- Ideal for landscape applications
- Louvered optics to minimise glare
- IP65 Ingress protection rating
- Matte black powder coated corrosion resistant finish

SPECIFICATIONS

MATITA

WATT	LUMEN	lm/W	TRIM	CCT	WEIGHT	SAP CODE	PRODUCT CODE
12W	780lm	65lm/W	BLACK	3000K	3.00kg	2000542	G12W120*650R3K52DC-BK

APPLICATIONS

- Driveways
- Paths
- Car parks
- Gardens

COLOURS



LIGHT OPTICS



Cut off at 50°x360° degrees.

50°x360°

DIAGRAMS

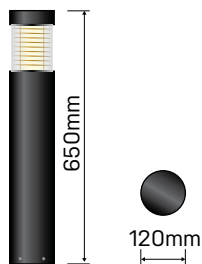

Emergency

Safety lighting

Unlike ordinary light fixtures, emergency lighting has an internal battery allowing illumination even when main power is out. Haneco has your emergency lighting requirements covered with both maintained and non-maintained safety solutions.



*Featured:
LUME*





Lume

STANDARDS



The LUME is series of reliable, lithium iron phosphate (LiFePO₄) powered LED emergency luminaires with integral control gear and battery design for simple installation. Available in either D40 or D63 emergency classification, the choice between recessed or surface mount make it ideal for any commercial application where emergency lighting is required.

- Available in D40 or D63 emergency classification
- Simple test button
- IC-4 Rating allows covering with building insulation
- Lithium iron phosphate (LiFePO₄) battery compliant with AS2293
- More than 2 hours discharge time
- Available in black or white finish

SPECIFICATIONS

LUME

STANDBY POWER	CLASSIFICATION	CCT	WEIGHT	SAP CODE	PRODUCT CODE
0.5W	D40	5700K	0.30kg	2002009	LUME1WD40
	D63			2001853	LUME3WD63
				0.35kg	2001869

* 140mm Adaptor (included)

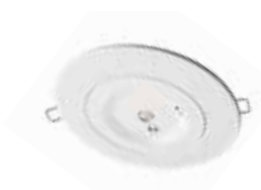

APPLICATIONS

- Schools
- Offices
- Hotels
- Retailers
- Galleries
- Factories
- Carparks
- Stairwells

COLOUR AND VARIANTS



WHITE



BLACK



D40: LUME1WD40
D63: LUME3WD63
LUME3WD63-BK



SURFACE MOUNT
LUME3WD63-SM

LIGHT OPTICS



Clean circular 150 degree beam output.

DIAGRAMS

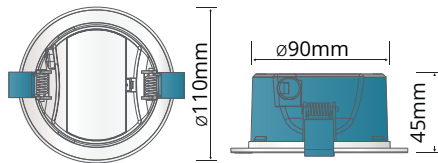

LUME1WD40

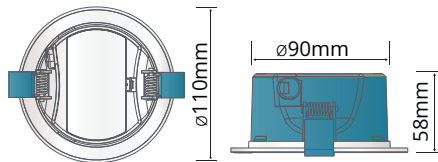

LUME3WD63



LUME3WD63
SURFACE MOUNT



Lume Remote

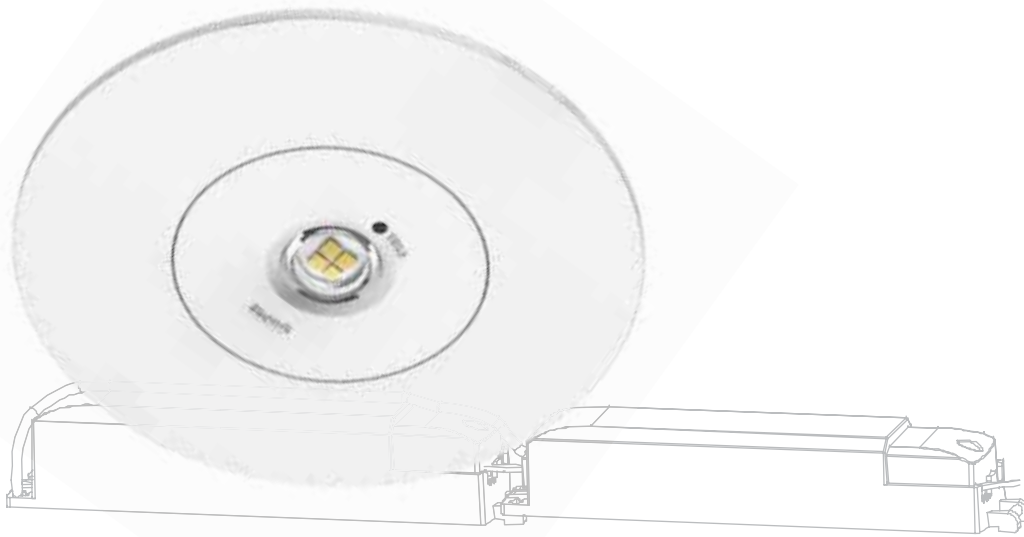

STANDARDS



The LUME REMOTE is series of reliable, lithium iron phosphate (LiFePO₄) powered LED emergency luminaires with integral control gear and battery design for simple installation. Available in D40 or D63 emergency classification, ideal for any commercial applications where emergency lighting is required.

- Available in D40 or D63 emergency classification
- Simple test button
- IC-4 Rating allows covering with building insulation
- Lithium iron phosphate (LiFePO₄) battery compliant with AS2293
- More than 2 hours discharge time

SPECIFICATIONS

LUME REMOTE

STANDBY POWER	CLASSIFICATION	CCT	MAX POWER (CHARGING)	SAP CODE	PRODUCT CODE
0.5W	D40	5700K	2.5W	2002088	LUME-D40-REMOT
	D63		4.5W	2002089	LUME-D63-REMOT

APPLICATIONS

- Schools
- Offices
- Hotels
- Retailers
- Galleries
- Factories
- Car parks
- Stairwells

COLOUR AND VARIANTS



WHITE



D40: LUME-D40-REMOT
D63: LUME-D63-REMOT

LIGHT OPTICS



Clean circular 150 degree beam output.

150°

DRIVER

H: 52.6 (D40) / 56.6 (D63)

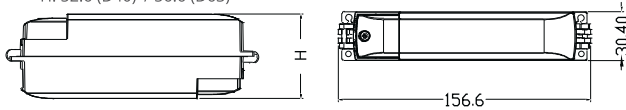

DIAGRAMS

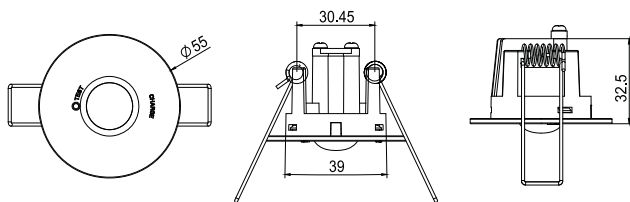

Esodo Box

STANDARDS



The ESODO BOX is a LED emergency EXIT sign presented in the conventional box design with easy installation and 24m standard viewing distance.

- High efficiency LED backlit sign
- Conventional box type design
- Easy surface mount installation
- Easy accessible manual test button
- Lithium iron phosphate (LiFePO₄) backup battery
- Replaceable decals supplied (*standard pictogram left and right arrows*)
- Complies with AS/NZS 60598 and AS/NZS 2293.3
- 24m standard viewing distance
- 3 Year Warranty

SPECIFICATIONS

ESODO BOX

LAMP POWER	VIEWING DISTANCE	DISCHARGE TIME	BATTERY TYPE	EMERGENCY CLASSIFICATION	SAP CODE	PRODUCT CODE
1W	24m	2 hours	LiFePO ₄ 3.2V 600mAh	C0:D2.5 C90:D2.0	2002086	ESD24M-BOX

APPLICATIONS

- Apartments
- Commercial spaces
- Schools
- Offices

COLOUR AND VARIANTS



WHITE



EVAC24M-BOX

INCLUDED DECALS



GO RIGHT
Pictogram



GO STRAIGHT
Pictogram



GO LEFT
Pictogram

DIAGRAMS

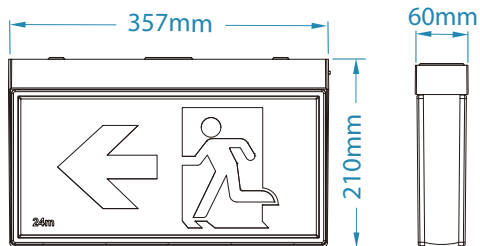

Esodo Edge

STANDARDS



The ESODO EDGE is a super slim LED emergency EXIT sign with multiple surface mounting options and 24m standard viewing distance.

- Low Power consumption: 1.5W
- Lithium iron phosphate (LiFePO₄) backup battery
- More than 1.5 hours discharge time
- 5 in 1 Surface Mount fitting
- Super slim design LED EXIT fitting
- Complies with AS/NZS 60598 and AS/NZS 2293.3
- 24m standard viewing distance
- Replaceable decals supplied (*standard pictogram left and right arrows*)

SPECIFICATIONS

ESODO EDGE

LAMP POWER	VIEWING DISTANCE	DISCHARGE TIME	BATTERY TYPE	EMERGENCY CLASSIFICATION	SAP CODE	PRODUCT CODE
1.5W	24m	>1.5 hours	LiFePO ₄ 3.2V 1.5Ah	E6.3	2002084	ESD24M-SM

APPLICATIONS

- High-end apartments
- Commercial spaces

COLOUR AND VARIANTS



WHITE



EVAC24M-SM



SIDE MOUNT BRACKET

INCLUDED DECALS



GO RIGHT
Pictogram



GO STRAIGHT
Pictogram



GO LEFT
Pictogram

DIAGRAMS

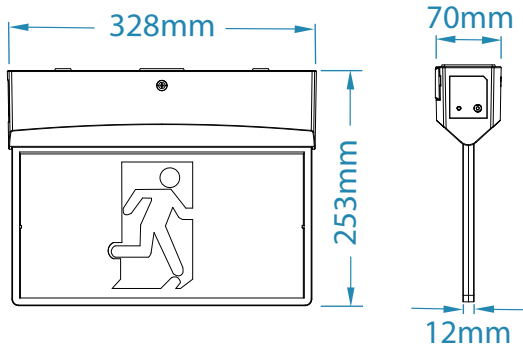

Esodo Edge *Recessed*

STANDARDS



The ESODO EDGE RECESSED is a super slim LED emergency EXIT sign with a streamlined hidden recessed mount and 24m standard viewing distance.

- High efficiency LED lamp with long lifetime and low power consumption
- Super slim design LED EXIT fitting
- Easy recessed mount installation
- Easy accessible manual test button
- Lithium iron phosphate (LiFePO₄) backup battery
- Complies with AS/NZS 60598 and AS/NZS 2293.3
- 24m standard viewing distance
- Replaceable decals supplied (*standard pictogram left and right arrows*)

SPECIFICATIONS

ESODO EDGE RECESSED

LAMP POWER	VIEWING DISTANCE	DISCHARGE TIME	BATTERY TYPE	EMERGENCY CLASSIFICATION	SAP CODE	PRODUCT CODE
1.5W	24m	>1.5 hours	LiFePO ₄ 3.2V 1.5Ah	E6.3	2002083	ESD24M-RC

APPLICATIONS

- High-end apartments
- Commercial spaces

COLOUR AND VARIANTS



WHITE



EVAC24M-RC

INCLUDED DECALS



GO RIGHT
Pictogram



GO STRAIGHT
Pictogram



GO LEFT
Pictogram

DIAGRAMS

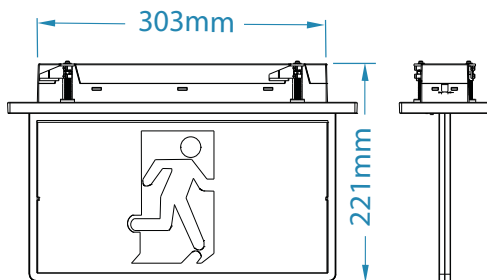

Esodo IP65

STANDARDS



The ESODO IP65 is a robust vandal resistant LED emergency EXIT sign with an easy installation design and 24m standard viewing distance.

- High efficiency LED lamp with long lifetime and low power consumption
- Vandal Resistant Impact Rating
- More than 1.5 Hours of Discharge Time
- Lithium iron phosphate (LiFePO₄) backup battery
- Replaceable decals supplied (*standard pictogram left and right arrows*)
- Complies with AS/NZS 60598 and AS/NZS 2293.3
- 24m standard viewing distance

SPECIFICATIONS

ESODO IP65

LAMP POWER	VIEWING DISTANCE	DISCHARGE TIME	BATTERY TYPE	EMERGENCY CLASSIFICATION	SAP CODE	PRODUCT CODE
1.5W	24m	>1.5 hours	LiFePO ₄ 3.2V 1.5Ah	E6.3	2002085	ESD24M-IP65

APPLICATIONS

- Carparks
- Schools
- Factories
- Public areas

COLOUR AND VARIANTS



WHITE



ESD24M-IP65

INCLUDED DECALS



GO RIGHT
Pictogram



GO STRAIGHT
Pictogram



GO LEFT
Pictogram

DIAGRAMS

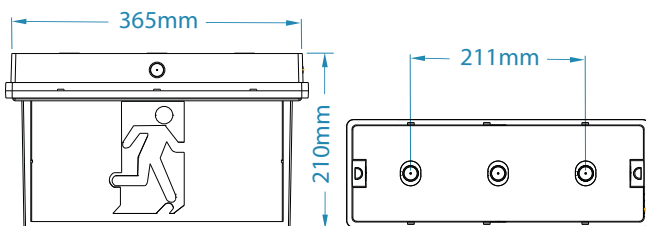

Duet



STANDARDS



The DUET is a 4W high performance lithium iron phosphate (LiFePO₄) powered LED Emergency Floodlight with a fully adjustable dual lamp design.

- 4W energy-efficient long lifetime LED lamp
- Fully adjustable dual lamp positioning
- Easy surface mount installation
- Accessible manual test button
- Self-charging lithium iron phosphate (LiFePO₄) battery
- Complete with internal screw terminals and external 1.2m flex and plug

SPECIFICATIONS

DUET

LAMP POWER	LUMEN	DISCHARGE TIME	BATTERY TYPE	CCT	SAP CODE	PRODUCT CODE
4W	2 x 250lm	>1.5 hours	LiFePO ₄ 3.2V 6.6Ah	5700K	2002087	DUET4W

APPLICATIONS

- Warehouse
- Factories
- Function Rooms
- Corridor
- Stairway

COLOUR AND VARIANTS



WHITE



DUET4W

DIAGRAMS

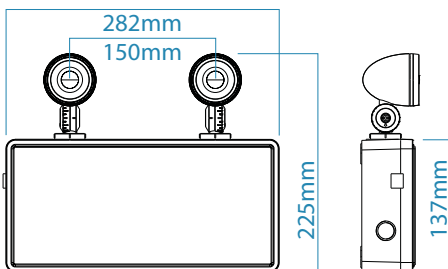

Vista^{EM}



STANDARDS



The VISTA EM is the perfect LED replacement for conventional battens. It enhances energy savings by offering efficiency and smart technology such as Intellisensor and Ecoswitch.

- Tritone selectable - 4000K, 4700K, 5700K
- Dual intensity selection with Ecoswitch (*non-sensor models*)
- Quick and easy installation
- 20mm cable entry, optional knockout and cables to suspend light while attaching the body
- Lithium iron phosphate (LiFePO₄) backup battery
- Intellisensor (MS) versions available

SPECIFICATIONS

VISTA EM

NOMINAL LENGTH 600mm (Standard mode)

POWER	LUMEN	lm/W	CCT	WEIGHT	SAP CODE	PRODUCT CODE
20W	2000lm	100lm/W	4000K	0.80kg	2001158	VISTA20W06-TRI-EM
	2200lm	110lm/W	4700K			
	2100lm	105lm/W	5700K			

NOMINAL LENGTH 1200mm (Standard and Low Power modes)

STANDARD MODE			LOW POWER MODE				WEIGHT	SAP CODE	PRODUCT CODE
POWER	LUMEN	lm/W	POWER	LUMEN	lm/W	CCT			
20-40W	4540lm	114lm/W	20W	2400lm	120lm/W	4000K	2.00kg	2001063	VISTA20/40W 12-TRI-EM
	4880lm	122lm/W		2510lm	126lm/W	4700K			
	4470lm	112lm/W		2430lm	122lm/W	5700K			

NOMINAL LENGTH 1200mm (Standard mode)

POWER	LUMEN	lm/W	CCT	WEIGHT	SAP CODE	PRODUCT CODE
40W	4120lm	114lm/W	4000K	2.00kg	2001065	VISTA40W12-TRI-SS-EM
	4570lm	122lm/W	4700K			
	4300lm	112lm/W	5700K			

* Standard and Intellisensor versions available.

APPLICATIONS

- Retail
- Offices
- Colleges, Schools
- Corridors
- Workshops

COLOURS**LIGHT OPTICS**

Cut off at 120 degrees.

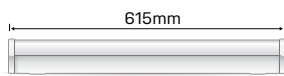
DIAGRAMS

VISTA 20W
Emergency

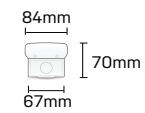

VISTA 20/40W
Emergency

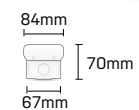

Vistalite^{EM}

STANDARDS



The VISTALITE EM is a sleek, narrow body batten. A low cost option for either for new installations or to replace single battens without compromising on features.

- Tritone selectable - 4000K, 4700K, 5700K
- Dual power selection available in 1200mm length
- Easy access terminal block (*on standard models*)
- Narrow body batten for new or retrofit applications
- Lithium iron phosphate (LiFePO₄) backup battery

SPECIFICATIONS

VISTALITE EM

NOMINAL LENGTH 600mm (Standard mode)

POWER	LUMEN	lm/W	CCT	WEIGHT	SAP CODE	PRODUCT CODE
20W	2080lm	104lm/W	4000K	1.90kg	2001631	VSL20W06-TRI-EM
	2230lm	112lm/W	4700K			
	2120lm	106lm/W	5700K			

NOMINAL LENGTH 1200mm (Standard and Low Power modes)

STANDARD MODE			LOW POWER MODE			CCT	WEIGHT	SAP CODE	PRODUCT CODE
POWER	LUMEN	lm/W	POWER	LUMEN	lm/W				
40W	4140lm	104lm/W	20W	2100lm	105lm/W	4000K	2.80kg	2001635	VSL20W40W12-TRI-EM
	4540lm	113lm/W	20W	2330lm	117lm/W	4700K			
	4610lm	115lm/W	20W	2390lm	119lm/W	5700K			

* Standard and Intellisensor versions available.

APPLICATIONS

- Retail
- Offices
- Colleges, Schools
- Corridors
- Workshops
- Education

COLOURS



LIGHT OPTICS



Cut off at 120 degrees.

DIAGRAMS

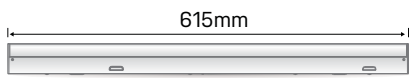

VISTALITE 20W
Emergency

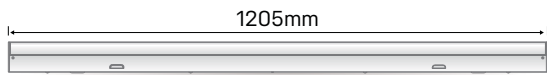
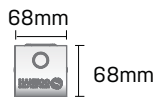

VISTALITE
20/40W
Emergency

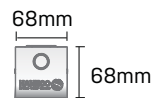

EMERGENCY LIGHTING



Vista hero EM



STANDARDS



The VISTA HERO EM is a conventional but elegant batten that is suitable for either new installations or as a replacement. 1230mm in length and 125mm in width it is also available in Intellisensor (MS) versions.

- Tritone selectable - 4000K, 4700K, 5700K
- Quadruple power selection available (*non-sensor models*)
- Provides even and uniform light distribution
- Lithium iron phosphate (LiFePO₄) backup battery
- White powder coated SPCC steel body
- Intellisensor (MS) versions available
- Smooth opal polycarbonate diffuser

SPECIFICATIONS

VISTA HERO EM

	POWER SETTING				CCT	EFFICACY
	40W	31W	26W	19W		
LUMEN OUTPUT	4300lm	3520lm	3150lm	2290lm	4000K	up to 117lm/W
	4460lm	3640lm	3210lm	2310lm	4700K	
	4140lm	3420lm	3030lm	2200lm	5700K	

VISTA HERO EM

MODEL LIST				
FEATURE	POWER SETTING	WEIGHT	SAP CODE	PRODUCT CODE
125mm Wide Body	40/31/26/19W	2.20kg	2001941	VISTA-HR12-EM
	40W	2.55kg	2001943	VISTA-HR12-EM-MS

* Standard and Intellisensor versions available.

APPLICATIONS

- Residential retrofit
- Offices
- Garages
- Industrial
- Retail

COLOURS



LIGHT OPTICS



Cut off at 120 degrees.

DIAGRAMS

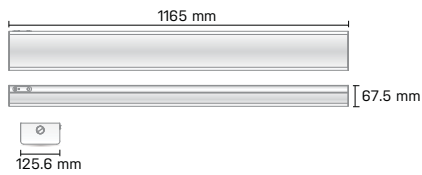

Emergency
VISTA^{hero}



Vista plus EM

STANDARDS



The VISTA PLUS EM is a premium wide body (110mm) LED batten with a stylish, smooth, satin polycarbonate diffuser. VISTA PLUS is also available in Intellisensor (MS) versions.

- Tritone selectable - 4000K, 4700K, 5700K
- Elegant LED batten perfect for retrofit
- Provides even and uniform light distribution
- Quadruple power selection available (*non-sensor models*)
- Lithium iron phosphate (LiFePO₄) backup battery
- Flicker-free driver for softer light

SPECIFICATIONS

VISTA PLUS EM

	POWER SETTING				CCT	EFFICACY
	40W	32W	29W	20W		
LUMEN OUTPUT	4700lm	3700lm	3300lm	2600lm	4000K	up to 133lm/W
	5000lm	3600lm	3350lm	2650lm	4700K	
	4700lm	3600lm	3300lm	2600lm	5700K	

VISTA PLUS EM

MODEL LIST					
FEATURE	POWER SETTING	WEIGHT	SIZE	SAP CODE	PRODUCT CODE
110mm Wide Body	40 / 32 / 29 / 20W	2.60kg	1221mm	2001926	VISTA-PL12-EM
	40W	2.60kg	1221mm	2001928	VISTA-PL12-EM-MS

* Standard and Intellisensor versions available.

APPLICATIONS

- Retail
- Office
- Industrial
- Commercial
- Car Parks

COLOURS



LIGHT OPTICS



Cut off at 120 degrees.

DIAGRAMS

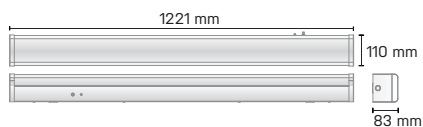

Emergency
VISTA^{plus}



Oxford^{EM}

STANDARDS



The OXFORD EM is an extra wide body LED batten with an aesthetically pleasing low glare design minimising clutter on the ceiling for offices, retail and school applications.

- Tritone selectable - 4000K, 4700K, 5700K
- 4 power switchable (*non-sensor versions only*)
- Low glare design with flicker-free driver
- Quick and easy installation
- Lithium iron phosphate (LiFePO₄) backup battery
- Simple twist-lock end caps to secure diffuser

SPECIFICATIONS

OXFORD

	POWER SETTING				CCT	EFFICACY
	40W	32W	29W	20W		
LUMEN OUTPUT	4200lm	3620lm	3140lm	2200lm	4000K	up to 115lm/W
	4400lm	3470lm	3280lm	2300lm	4700K	
	4200lm	3440lm	3130lm	2200lm	5700K	

OXFORD

MODEL LIST					
FEATURE	POWER SETTING	WEIGHT	SIZE	SAP CODE	PRODUCT CODE
212mm Super Wide	40 / 32 / 29 / 20W	4.00kg	1220mm	2001886	OXFORD12-EM
	40W	4.00kg	1220mm	2001888	OXFORD12-EM-MS

* Standard and Intellisensor versions available.

APPLICATIONS

- Schools
- Offices
- Retail

COLOURS



LIGHT OPTICS



Cut off at 120 degrees.

DIAGRAMS

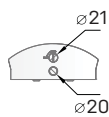
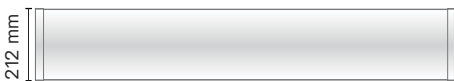

Triproof^{EM}



STANDARDS



The TRIPROOF EM outdoor LED battens feature a robust IK08 vandal resistant construction and are also available with Ecoswitch to minimise waste.

- Tritone selectable - 4000K, 5000K, 6500K
- Durable polycarbonate and UV stabilised
- Stainless steel tamper proof clips
- Vandal resistant construction
- PG16 cable entry with optional knockout
- Lithium iron phosphate (LiFePO₄) backup battery
- Quick and easy installation

SPECIFICATIONS

TRIPROOF EM

NOMINAL LENGTH 600mm (Standard mode)

POWER	LUMEN	lm/W	CCT	WEIGHT	EMERGENCY CLASSIFICATION	BATTERY	SAP CODE	PRODUCT CODE
20W	1850lm	93lm/W	4000K	2.20kg	C0=D50 C90=D32	LiFePO ₄	2001165	TRIPROOF 20W06-TRI-EM
	1990lm	100lm/W	5000K					
	1850lm	93lm/W	6500K					

NOMINAL LENGTH 1200mm (Standard and Low Power modes)

STANDARD MODE			LOW POWER MODE				CCT	WEIGHT	EMERGENCY CLASSIFICATION	BATTERY	SAP CODE	PRODUCT CODE
POWER	LUMEN	lm/W	POWER	LUMEN	lm/W							
40W	4090lm	102lm/W	20W	2230lm	111lm/W	4000K	2.20kg	C0=D63 C90=D32	LiFePO ₄	2001066	TRIPROOF 20/40W12- TRI-EM	
	4410lm	110lm/W		2250lm	113lm/W	5000K						
	4050lm	101lm/W		1970lm	98lm/W	6500K						
40W	4090lm	102lm/W	-	-	-	4000K	2.20kg	C0=D63 C90=D32	LiFePO ₄	2001068	TRIPROOF 40W12-TRI- SS-EM	
	4410lm	110lm/W	-	-	5000K							
	4050lm	101lm/W	-	-	6500K							

NOMINAL LENGTH 1500mm (Standard mode)

POWER	LUMEN	lm/W	CCT	WEIGHT	EMERGENCY CLASSIFICATION	BATTERY	SAP CODE	PRODUCT CODE
60W	5600lm	93lm/W	4000K	3.70kg	C0=D50 C90=D32	LiFePO ₄	2001171	TRIPROOF 60W15-TRI-EM
	6000lm	100lm/W	5000K					
	5700lm	93lm/W	6500K					

* Standard and Intellisensor versions available.

APPLICATIONS

- Outdoor
- Industrial
- Sport Halls
- Public Amenities

COLOURS



LIGHT OPTICS



Cut off at 120 degrees.

DIAGRAMS

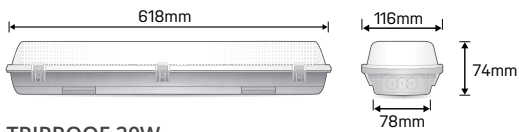

TRIPROOF 20W

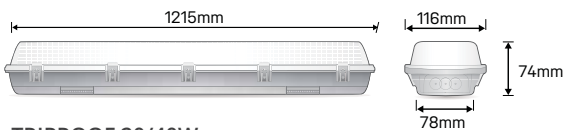

TRIPROOF 20/40W

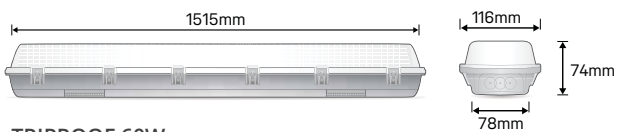

TRIPROOF 60W



Duralite^{EM}



STANDARDS



The DURALITE EM LED batten is ideal for use in utility-type applications such as car parks, workshops, storerooms and back of house areas. It features IP66 ingress protection and an impact resistance rating of IK09,

- Tritone selectable - 4000K, 4500K, 5000K
- Multi intensity weatherproof LED batten
- Anti-corrosive with stainless steel tamper proof clips
- Durable polycarbonate and UV stabilised
- Lithium iron phosphate (LiFePO₄) backup battery
- Intellisensor (MS) versions available

SPECIFICATIONS

DURALITE EM

NOMINAL LENGTH 600mm

POWER	LUMEN	lm/W	CCT	WEIGHT	SAP CODE	PRODUCT CODE
20W 17W 14W 11W	2090 / 2160 / 2070lm 1700 / 1800 / 1700lm 1400 / 1500 / 1400lm 1100 / 1200 / 1100lm	105lm/W	4000K 4500K 5000K	1.30kg	2001497	DURALITE20W06-EM
20W 18W 16W 15W 13W 12W	2024 / 2164 / 2069lm 1800 / 1890 / 1800lm 1600 / 1680 / 1600lm 1500 / 1580 / 1500lm 1300 / 1350 / 1300lm 1200 / 1250 / 1200lm	105lm/W	4000K 4500K 5000K	1.30kg	2002003	DURALITE20W06-SS-EM

NOMINAL LENGTH 1200mm

POWER	LUMEN	lm/W	CCT	WEIGHT	SAP CODE	PRODUCT CODE
36W 30W 25W 18W	4160 / 4380 / 4250lm 3750 / 3800 / 3730lm 3130 / 3150 / 3100lm 2720 / 2740 / 2680lm	125lm/W	4000K 4500K 5000K	2.40kg	2002005	DURALITE35W12-SS-EM
36W 30W 25W 18W	4160 / 4380 / 4150lm 3750 / 3800 / 3730lm 3130 / 3150 / 3100lm 2720 / 2740 / 2680lm	125lm/W	4000K 4500K 5000K	2.40kg	2001499	DURALITE18/36W12-EM

* Standard and Intellisensor versions available.

APPLICATIONS

- Outdoors
- Industrial
- Sport Halls
- Public Amenities
- Car Parks

COLOURS



LIGHT OPTICS

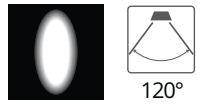

Cut off at 120 degrees.

DIAGRAMS

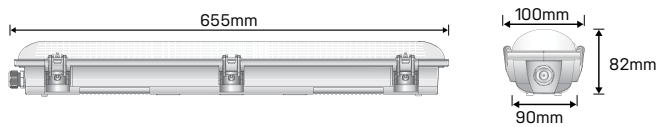

DURALITE 20W

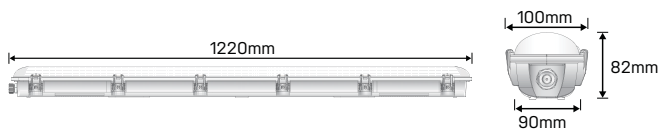

DURALITE 18/36W



Puro G2^{EM}

STANDARDS



The PURO G2 EM is a range of LED oyster lights providing Tritone colour selection, smooth light distribution and a flicker-free technology. This light is perfect for indoor residential applications.

- Tritone selectable - 3000K, 4000K, 5000K
- Available in 250mm, 300mm and 400mm
- Opal PMMA twist lock diffuser for ease of installation
- Intellisensor (MS) version available (15W and 25W)
- Lithium iron phosphate (LiFePO₄) backup battery
- Integral flicker-free driver (*non-sensor versions*)

SPECIFICATIONS

PURO G2 EM

POWER	LUMEN	lm/W	CCT	WEIGHT	SAP CODE	PRODUCT CODE
25W	2140lm	85lm/W	3000K	1.1kg	2001989	PURO25W400R-EM
	2420lm	97lm/W	4000K			
	2330lm	93lm/W	5000K			
	2140lm	85lm/W	3000K	1.1kg	2001991	PURO25W-EM-MS
	2420lm	97lm/W	4000K			
	2330lm	93lm/W	5000K			

* Standard and Intellisensor versions available.

APPLICATIONS

- Residential
- Hallways
- Stairwells
- Porches
- Interior ceilings
- Hospitality
- Utility Rooms

COLOUR AND VARIANTS



WHITE



LIGHT OPTICS



Clean circular 120 degree beam output.

DIAGRAMS

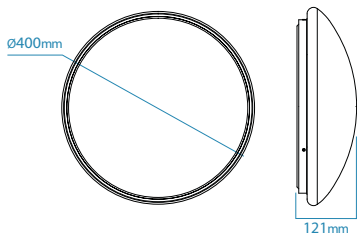

PURO 25W



Discus^{EM}



STANDARDS



The DISCUS EM is a sleek, aesthetically designed oyster light with slim body profile and IP54 protection rating that allows the fitting to be installed in both indoor and outdoor applications. It also comes in Intellisensor (MS) versions.

- Tritone selectable - 3000K, 4000K, 5700K
- IP54 Protection for damp area installations
- Polycarbonate body and opal acrylic diffuser
- Intellisensor (MS) version available
- Lithium iron phosphate (LiFePO₄) backup battery
- External dip switches for sensor configuration

SPECIFICATIONS

DISCUS EM

POWER	LUMEN	lm/W	CCT	WEIGHT	SAP CODE	PRODUCT CODE
25W	2040lm	81lm/W	3000K	1.2kg	2001936	DISC25W300R-EM
	2190lm	87lm/W	4000K			
	2080lm	83lm/W	5700K			
	2040lm	81lm/W	3000K	1.2kg	2001938	DISC25W-EM-MS
	2190lm	87lm/W	4000K			
	2080lm	83lm/W	5700K			

* Standard and Intellisensor versions available.

APPLICATIONS

- Retail
- Commercial
- Residential
- Colleges, Schools
- Offices
- Exterior Walls
- Under Eaves
- Stairwell

COLOUR AND VARIANTS



WHITE



LIGHT OPTICS



Clean circular 120 degree beam output.

DIAGRAMS

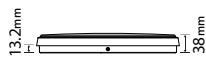
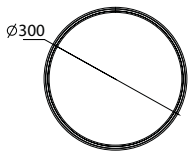

DISCUS 25W



Dawn EM



STANDARDS



The DAWN EM is a range of round LED bunker lights. It has an IP66 rating and is available with an eyelid making it ideal for outdoor applications such as, apartment buildings, schools or public areas.

- Robust powder coated aluminium body
- Large terminal block for easy installation
- UV Stabilised polycarbonate diffuser
- IP66 Ingress protection and IK10 Impact ratings
- Lithium iron phosphate (LiFePO₄) backup battery

SPECIFICATIONS

DAWN EM

POWER	FEATURE	LUMEN	lm/W	CCT	WEIGHT	SAP CODE	PRODUCT CODE
20W	Opal diffuser Round	2050lm	103lm/W	3000K	1.80kg	2001911	DN20WRND-TRI-EM
		2050lm	103lm/W	4000K			
		1890lm	95lm/W	5000K			
30W	Opal diffuser Round	2760lm	92lm/W	3000K	2.80kg	2001914	DN30WRND-TRI-EM
		3000lm	100lm/W	4000K			
		2770lm	92lm/W	5000K			

* Standard and Intellisensor versions available.

DAWN EM accessories

ACCESSORIES	FEATURE	SAP CODE	PRODUCT CODE
Round eyelid (for 20W only)	270mm trim	2001701	DNRND-EL270

APPLICATIONS

- Exterior walls
- Under eaves
- Stairs
- Industrial

COLOURS



LIGHT OPTICS

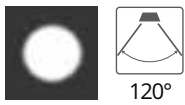

Cut off at 120 degrees.

DIAGRAMS



DAWN 30W
ROUND



DAWN 20W
ROUND



Matrix G3^{EM}

STANDARDS

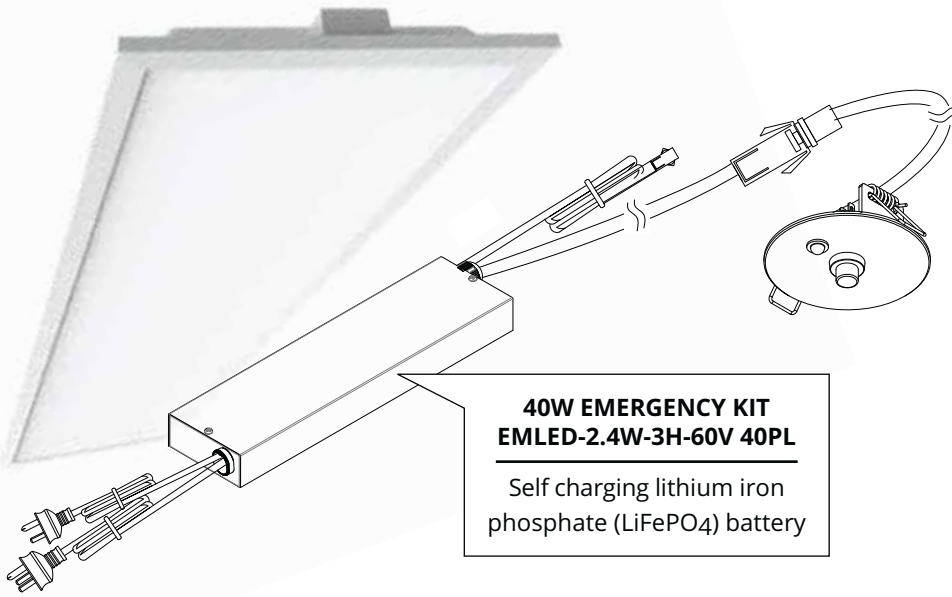

40W EMERGENCY KIT EMLED-2.4W-3H-60V 40PL

Self charging lithium iron phosphate (LiFePO₄) battery

The MATRIX G3 EM panel is Tritone selectable, with a genuine 4000K setting ensuring a pure light at this level. The back-lit panel has been redesigned and manufactured on an automated line, with extra steps built in to ensure the panels have high quality and extra strength to prevent bending.

- Tritone selectable - 4000K, 4500K, 5000K
- Back-lit panel with genuine 4000K
- Perfect for T-bar grid suspended ceilings
- Flicker-free technology
- Phase-cut, 1-10 and DALI dimming on request
- Lithium iron phosphate (LiFePO₄) backup battery

SPECIFICATIONS

MATRIX G3 EM 300mm wide

SIZE	LUMEN	CCT	POWER	EMERGENCY CLASSIFICATION	PRODUCT CODE
300 x 1200mm			28W	C0: D63 C90: D63	MATRIX0312-EM
600 x 600mm	3600lm	4000K	32W	C0: D63 C90: D63	MATRIX0606-EM
	3700lm	4500K	36W		
	3600lm	5000K	40W	C0: D50 C90: D63	MATRIX0612-EM

APPLICATIONS

- Office
- Education
- Commercial

COLOURS



LIGHT OPTICS



Cut off at 110 degrees.

DIAGRAMS

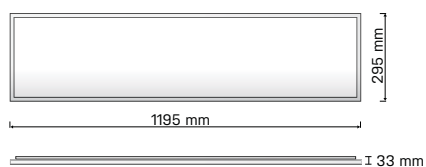

MATRIX 1200mm
x 300mm

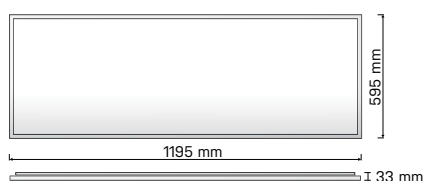

MATRIX 1200mm
x 600mm

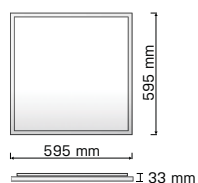

MATRIX 600mm
x 600mm



Retrofit

Replacement lighting

LED globes are a quick and easy way to upgrade to energy efficient lighting without investing in a complete infrastructure overhaul. LED Lights are also much cooler than their incandescent predecessors which improves their lifespan.



*Featured:
A60 Globe*





A60



STANDARDS



The retrofit A60 globe is the perfect LED replacement lamp for existing luminaires.

- Edison E27 screw and bayonet B22 lamp base available
- Pearl opal diffuser
- Low glare output

SPECIFICATIONS

A60 GLOBE

POWER	FEATURE	LUMEN	lm/W	CCT	SAP CODE	PRODUCT CODE
9W	Edison E27	820lm	91lm/W	3000K	2000067	B9W60R3KE27
	Bayonet B22				2000066	B9W60R3KB22
9W	Edison E27	980lm	109lm/W	6500K	2000069	B9W60R6KE27
	Bayonet B22				2000068	B9W60R6KB22

APPLICATIONS

- Residential
- Retrofit

LIGHT OPTICS



Clean circular 180 degree beam output.

180°

DIAGRAMS

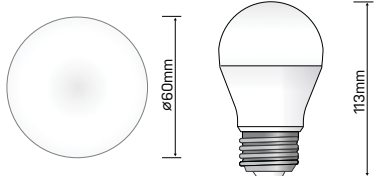

B9W60R3KE27

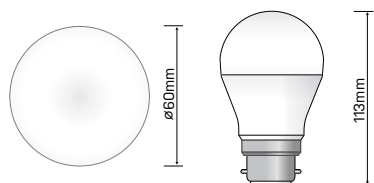

B9W60R3KB22



PAR38



STANDARDS

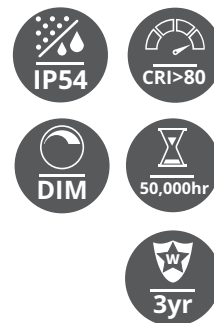

The PAR38 is a simple LED Retrofit Globe for existing luminaires. It features IP54 weather resistance and is fully compatible with standard screw in Par38 lamp holders.

- Edison E27 screw lamp base
- Pearl opal diffuser
- Dimmable
- Low glare output

SPECIFICATIONS

PAR38 GLOBE

POWER	FEATURE	LUMEN	lm/W	CCT	SAP CODE	PRODUCT CODE
15W	Edison E27	1390 lm	93 lm/W	5000K	2000821	PAR15W38-5K

APPLICATIONS

- Residential
- Security
- Retrofit

LIGHT OPTICS



60 degree beam spread with precise circular beam output.

60°

DIAGRAMS

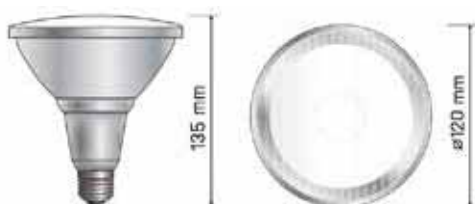

LED Tube

STANDARDS



LED Tubes are superior to fluorescent tubes because of their improved energy efficiency, safety and a durable non-toxic housing.

- Provides over 50% energy savings when replacing conventional fluorescent tubes
- Virtually unbreakable polycarbonate body with glass and mercury free

SPECIFICATIONS

LED TUBE

POWER	FEATURE	LUMEN	lm/W	CCT	SAP CODE	PRODUCT CODE
7W	600mm	850lm	121lm/W	6500K	2001135	LEDTUBE7W06-6K
10W	1212mm	1680lm	168lm/W	4000K	2001890	LEDTUBE10W12-4K
		1700lm	170lm/W	6500K	2001891	LEDTUBE10W12-6K

APPLICATIONS

- Supermarkets
- Factories
- Residential
- Retrofit

LIGHT OPTICS



200°

Cut off at 200 degrees.

DIAGRAMS

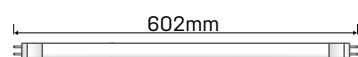

⊙ 26mm

LED TUBE 7W

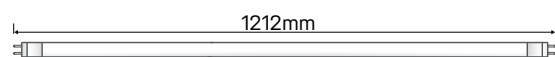

⊙ 26mm

LED TUBE 10W



Lighting Control

Smart lighting

The Haneco Lighting Control Range consists of dimmers, sensors to smart lighting. Sensors are capable to measure light intensity and type and also the presence of people in the area.



*Featured:
SENTURA*



Duo 350 Dimmer



STANDARDS



The DUO 350 Dimmer features a simple 2 wire design for easy installation. The subtle and adjustable backlighting makes it is easy to locate in the dark.

- Suitable for compatible Haneco LED fittings
- Load correction capacitor included for loads < 10W
- Simple 2 wire design for easy installation
- Integrated switch and dimmer knob
- Compatible with standard wall plates & apertures
- 2-way and 3-way compatible

SPECIFICATIONS

DUO 350 DIMMER

FEATURE	DIMMING METHOD	MAX LOAD WATTAGE	SAP CODE	PRODUCT CODE
DUO Dimmer	Phase-Cut Dimming	350W *	2001203	DUO350W-W

DUO 350 DIMMER accessories

FEATURE	SAP CODE	PRODUCT CODE
Black Knob	2001214	DUO-KNOB-BK

* Over thirty 10W LED downlights

APPLICATIONS

- Residential
- Hospitality
- Commercial

OPTIONS



BLACK Knob
DUO-KNOB-BK

DIAGRAMS

TWO WAY SWITCHING
(ON/OFF DISABLED)

ACTIVE

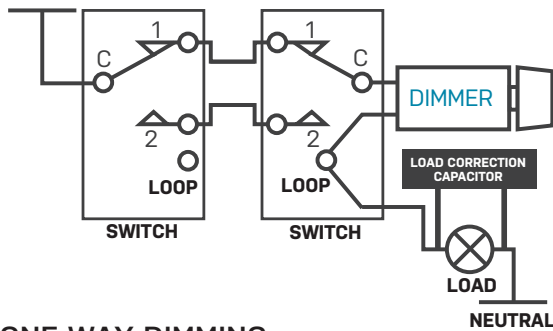

ONE WAY DIMMING
(ON/OFF ENABLED)

UNSWITCHED ACTIVE

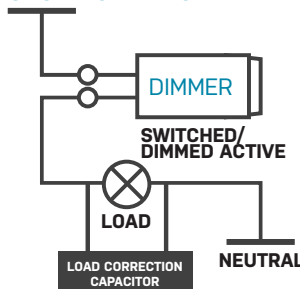

Sentura

STANDARDS



The SENTURA is a ceiling mounted 360° PIR sensor that can pick up movements over a large area with detection range up to 20m. It is ideal for applications such as corridors and carports.

- Passive infrared motion sensor (360° detection)
- 10sec to 30min time setting
- 3 to 2000lux level setting
- 3-wire input design for easy installation
- Maximum load: 2000W (*Incandescent*)
1000W (*Fluorescent & LED*)

SPECIFICATIONS

SENTURA 360°

FEATURE	INSTALL	MAX LOAD WATTAGE	SAP CODE	PRODUCT CODE
SENTURA 360° IP65 PIR sensor	Ceiling mount	2000W (Incandescent) 1000W (Fluorescent & LED)	2001528	SENTURA-SMPIR360

APPLICATIONS

- Hallways
- Carports

DIAGRAMS

Sensor Diagram

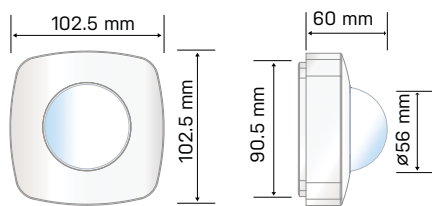
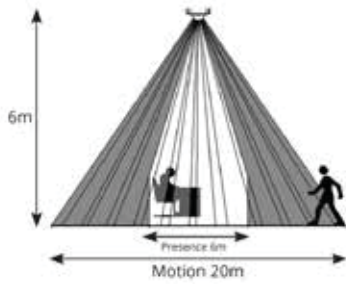

SENTURA 360°
IP65 PIR sensor



Intellisensor

The INTELLISENSOR is a smart, easily adjustable, auto dimming function that revolutionises standby lighting. Compatible with Haneco PURO & DISCUS oysters, VISTA, VISTA PLUS & VISTA HERO and TRIPROOF, OXFORD battens.

- Total control - 5-way programmable DIM switch
- On time - for automatically full illumination up to 30 minutes
- Standby time - for automatically dimmed standby mode, from 0 seconds to permanent standby
- Standby level - adjustable to 4 light levels to suit your security/safety requirements
- Detection range - adjustable sensitivity, either 100% (approx. 5m) or 50% (approx. 3m)
- Daylight override - to save energy during the day (>50Lux)



SPECIFICATIONS

INTELLISENSOR

STANDBY POWER	DETECTION RANGE	HOLD TIME	STANDBY TIME	STANDBY DIMMING LEVEL
0.5W	15x16m	5sec-30min	0s to 30min+	10% to 50%

For more information and simplified setting guide, please visit www.haneco.com.au/intellisensor

RECOMMENDED INTELLISENSOR SETTINGS

Stairwell



Classroom, workshop / small factory



Corridor



Office / Meeting Room

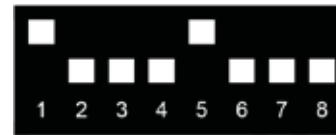

Carport



Laundry / Patio



APPLICATIONS

- Stairwells
- Carparks
- Offices
- Warehouses
- Colleges, Schools
- Education

RECOMMENDED INTELLISENSOR SETTINGS

Stairwell

Detection Range(SW1)	100%
Light ON hold time (SW2/3)	1min at max output
Daylight Sensor(SW4)	Off (disable)
Standby Period (SW5/6)	Permanent ∞
Standby Level (SW7/8)	30% of max output

Corridor

Detection Range(SW1)	100%
Light ON hold time (SW2/3)	10mins at max output
Daylight Sensor(SW4)	Off (disable)
Standby Period (SW5/6)	Permanent ∞
Standby Level (SW7/8)	20% of max output

Carpport

Detection Range(SW1)	100%
Light ON hold time (SW2/3)	10mins at max output
Daylight Sensor(SW4)	Off (disable)
Standby Period (SW5/6)	No standby
Standby Level (SW7/8)	NOT APPLICABLE

Classroom, Workshop / Small Factory

Detection Range(SW1)	100%
Light ON hold time (SW2/3)	30mins at max output
Daylight Sensor(SW4)	Off (disable)
Standby Period (SW5/6)	30mins
Standby Level (SW7/8)	30% of max output

Office / Meeting Room

Detection Range(SW1)	50%
Light ON hold time (SW2/3)	10mins at max output
Daylight Sensor(SW4)	On (50lux)
Standby Period (SW5/6)	5mins
Standby Level (SW7/8)	10% of max output

Laundry / Patio

Detection Range(SW1)	50%
Light ON hold time (SW2/3)	10mins at max output
Daylight Sensor(SW4)	Off (disable)
Standby Period (SW5/6)	5mins
Standby Level (SW7/8)	10% of max output





From smart automated solutions that add convenience to a home, to expanded electrical solutions that overcome wiring limitations in commercial spaces, the suite of **KASTA** smart products applies to a wide variety of custom applications. Empowering electrical contractors to stay ahead of the curve by future proofing their work with an ever-expanding range of modular control solutions.

KASTA Technologies' automation and controls are completely modular without compromising on sophistication and delivering an exceptional experience that can be seamlessly integrated into the automation platform ecosystem or simply retrofit to existing infrastructure. This range is based on wireless technology and no additional cabling, unlike more complex systems on the market. **KASTA** intelligent devices are IoT ready; allowing the customer to grow their automation and controls system as and when required.

KASTA Technologies, an Australian company, is devoted to providing customers with sophisticated technology to enhance their lifestyle. **Haneco Lighting** is a committed and proud distributor of **KASTA** smart products utilising their distribution and customer-service centres nationwide.

KASTA and **Haneco** – Providing comprehensive support for customers with innovative technology, excellent system solutions, outstanding quality and trustworthy reliability.

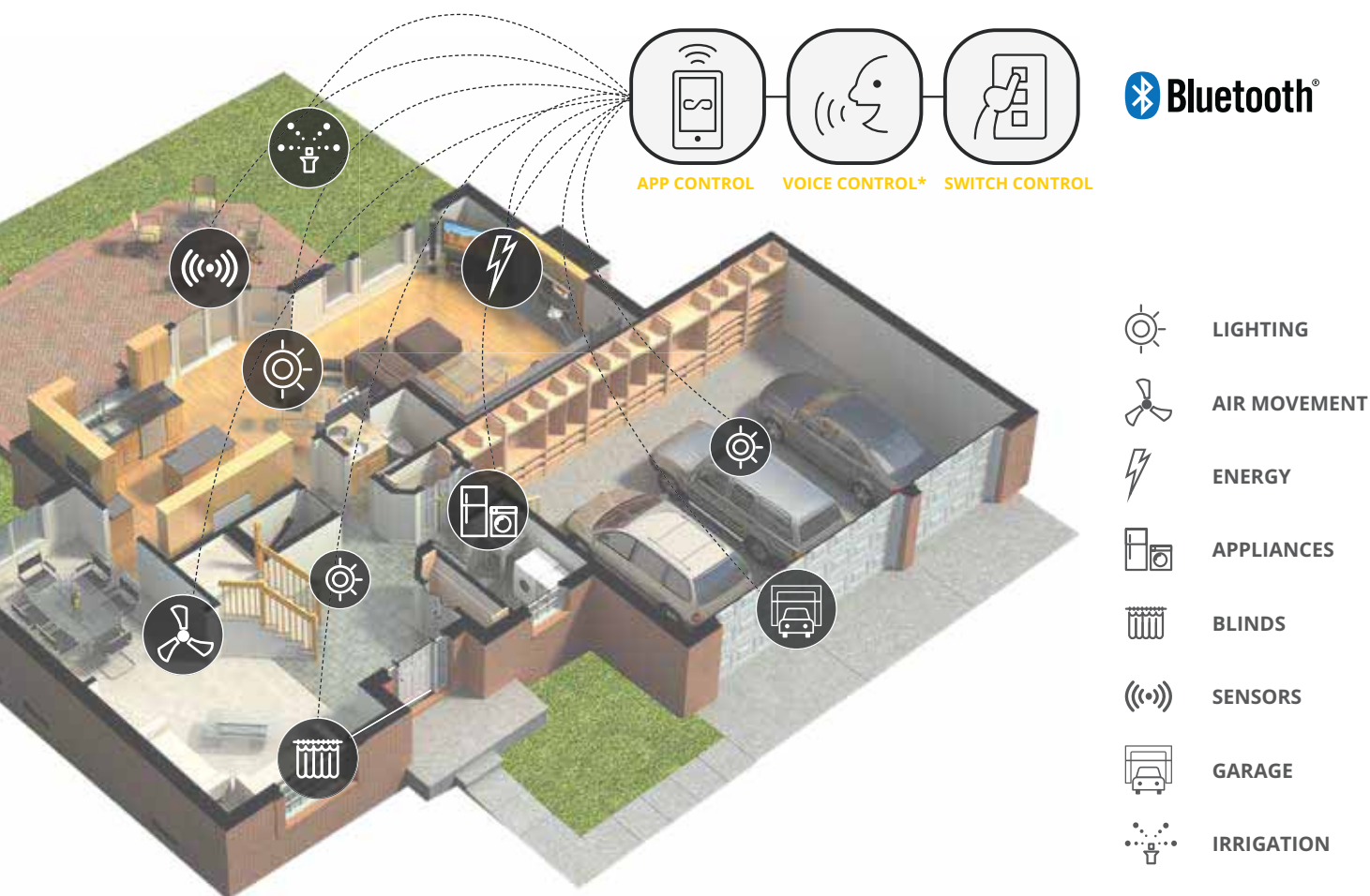

*Voice control via a smart speaker is available when using a KASTA Cloud Connect Gateway

KASTA app

Living **Enhanced** starts at your fingertips - just one touch can take control of your whole home ecosystem.

Compatible on both iOS and Android platforms across all smart phones and tablet devices.

Designed to work seamlessly throughout your home environment, connecting to your smart devices and creating limitless possibilities to personalise and control your space in one simple, intuitive app.

Control and personalise your whole home; opening the garage door, turning lights on, opening curtains, controlling TV power, switching on irrigation, controlling air movement and much more.



Wireless control and remote access

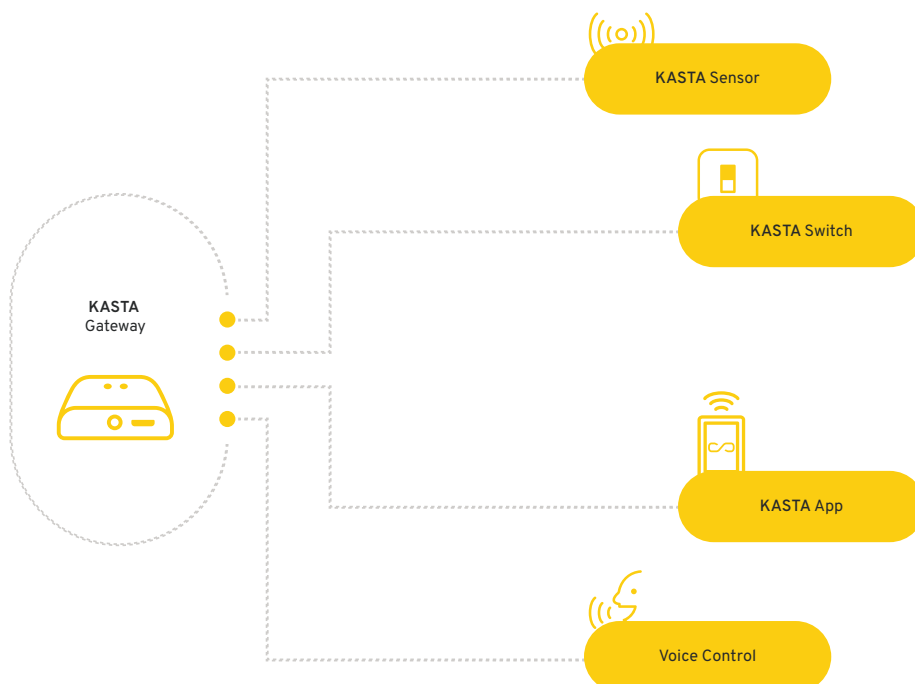

Utilising a strong, secure and reliable Bluetooth® mesh signal, **KASTA's** wireless ecosystem has been quoted as an effective leader in communications compared to others in the market.

Using a **KASTA Cloud Connect Gateway** enables you to monitor and control your system remotely, securely and with ease.

Cloud Connect Gateway

KASTA-CCGW



Smart Cloud Connect Gateway, Bluetooth® CSR mesh, Wi-Fi (Voice Control & Cloud Control)

FEATURES

- Interfaces and connects a KASTA Bluetooth® mesh network with the Local Area Network and Internet using Wi-Fi
- Provides users with remote access to their KASTA mesh network for control and monitoring
- Provides users voice control functionality through smart speakers
- Supports core KASTA functionality - control devices, groups, scenes, timers and schedules
- Packaged with USB power adaptor and 1m micro-USB cable
- iOS and Android app setup and control
- 3 year warranty

*Note: an active internet connection is required with this product.

SPECIFICATIONS

Power Supply	5V d.c. 1A (240V a.c. adaptor supplied)
Operating Ambient Temperature	-10 to 55°C
Bluetooth® Connectivity	Qualcomm®, Bluetooth®, CSRmesh™
Wi-Fi Connectivity	Wi-Fi 802.11 g/b/n, 2.4Ghz
No. of supported KASTA systems	1
Smart Speaker Support	Amazon Echo, Google Home
IP Rating	IP20
Colour	White
Housing Material	Polycarbonate (PC), Acrylonitrile Butadiene Styrene (ABS)
LED Indicators	Blue, Red
Standards Complied	AS/NZS 62368.1, AS/NZS 4268, AS/NZS CISPR 32

5-Button Battery Powered Handheld Remote

KASTA-5BCBH-W



Smart battery powered, capacitive touch, handheld remote controller

FEATURES

- Reliable Bluetooth® mesh network connectivity for control of all your KASTA devices
- Lithium battery powered remote controller
- Short press for ON/OFF control
- Long press for dimming control (where KASTA dimming devices are used)
- Supports core KASTA functionality - control devices, groups and scenes
- Built-in magnetic base provides additional mounting options
- User-replaceable CR2032 batteries
- iOS and Android app setup and control
- 3 year warranty (excluding batteries)

SPECIFICATIONS

Power Supply	CR2032 Lithium Battery x2
Battery Life	Up to 1 year (approx. 50,000 presses)
Operating Ambient Temperature	0 to 40°C
IP Rating	IP20
Colour	White
Housing Material	Polycarbonate (PC)
LED Indicators	Blue (activates on button push)
Standards Complied	AS/NZS 4268, AS/NZS CISPR 15, AS/NZS 60598.1 (part thereof)

Battery Powered Remote Switch Mechanism

KASTA-RB02-W



Smart battery powered remote switch mechanism that clips into standard wall plate

FEATURES

- Reliable Bluetooth® mesh network connectivity for control of all your KASTA devices
- Lithium battery powered remote switch control
- Short press for ON/OFF control
- Long press for dimming control (where KASTA dimming devices are used)
- Supports core KASTA functionality - control devices, groups and scenes
- Timer (when enabled) supports 2 modes; ON>OFF and OFF>ON and retriggered on a button press
- Suits most Australian wall plates
- Supplied with White button caps (2 x styles)
- iOS and Android app setup and control
- 3 year warranty (excluding batteries)

SPECIFICATIONS

Power Supply	CR2032 Lithium Battery x2
Battery Life	Up to 1 year (approx. 50,000 presses)
Operating Ambient Temperature	-20 to 40°C
IP Rating	IP20
Housing Material	Polycarbonate (PC)
LED Indicators	Blue
Standards Complied	AS/NZS 4268, AS/NZS CISPR 15

Remote Switch Mechanism

KASTA-1BMBH-W



Smart push button remote switch mechanism that clips into standard wall plate

FEATURES

- Reliable Bluetooth® mesh network connectivity for control of all your KASTA devices
- 2 wire connection for mains power
- Slim design allows installation up to 6-gang onto a standard wall plate
- Short press for ON/OFF control
- Long press for dimming control (where KASTA dimming devices are used)
- Supports core KASTA functionality - control devices, groups, scenes, timers and scheduling
- Suits most Australian wall plates
- Supplied with White button caps (2 x styles)
- iOS and Android app setup and control
- 3 year warranty

SPECIFICATIONS

Power Supply	220-240V a.c. 50Hz
Operating Ambient Temperature	-20 to 40°C
IP Rating	IP20
Physical Connection Type	Fly leads
Wiring Connections	Active & Neutral
Housing Material	Polycarbonate (PC)
LED Indicators	Blue
Standards Complied	AS/NZS 60950.1, AS/NZS CISPR 15, AS/NZS 4268

Switch Relay Mechanism

KASTA-RM1440BH-W



Smart push button switch relay mechanism that clips into standard wall plate

FEATURES

- Max. load 1440W or 100W motor
- Slim design allows installation up to 6-gang onto a standard wall plate
- Reliable Bluetooth® mesh network connectivity to all your KASTA devices
- 8-way multiway control
- Short press for ON/OFF control
- Current overload protection
- Supports core KASTA functionality - control devices, groups, scenes, timers and scheduling
- Suits most Australian wall plates
- Supplied with White button caps (2 x styles)
- iOS and Android app setup and control
- 3 year warranty

SPECIFICATIONS

Power Supply	220-240V a.c. 50Hz
Operating Ambient Temperature	-20 to 40°C
IP Rating	IP20
Thermal Derating	25 to 40°C (1440W-475W)
Physical Connection Type	Fly leads
Wiring Connections	Active, Load & Neutral
LED Load Wattage	15W - 1440W*
Multi-gang Derating	2-1300W, 3-1150W, 4-950W, 5-720W, 6-475W @ 25°C
Housing Material	Polycarbonate (PC)
LED Indicators	Blue
Standards Complied	CoS SAA 183650, AS/NZS 60669.2.1, AS/NZS 60669.1, AS/NZS CISPR 15, AS/NZS 4268

*May require load correct capacitor if less than 15W (supplied in box). Suitable for use with small fan motors <100W (0.5A @ 0.8pF).

2-Wire Switch Relay Mechanism

KASTA-S350BH-W



Smart 2-wire push button switch relay mechanism that clips into standard wall plate

FEATURES

- Max. load 350W
- 2 wire connection for easy installation
- Reliable Bluetooth® mesh network connectivity to all your KASTA devices
- 8-way multiway control
- Short press for ON/OFF control
- Current overload protection
- Supports core KASTA functionality - control devices, groups, scenes, timers and scheduling
- Suits most Australian wall plates (up to 3-gang)
- Supplied with White button caps (2 x styles)
- iOS and Android app setup and control
- 3 year warranty

SPECIFICATIONS

Power Supply	220-240V a.c. 50Hz
Operating Ambient Temperature	-20 to 40°C
IP Rating	IP20
Thermal Derating	25 to 40°C (350W-190W)
Physical Connection Type	Fly leads
Wiring Connections	Active & Load
LED Load Wattage	15W - 350W*
Multi-gang Derating	2-260W, 3-190W @ 25°C
Housing Material	Polycarbonate (PC)
LED Indicators	Blue
Standards Complied	CoS SAA 183650, AS/NZS 60669.2.1, AS/NZS 60669.1, AS/NZS CISPR 15, AS/NZS 4268

*May require load correct capacitor if less than 15W (supplied in box).

Switch Relay Module

KASTA-S2400IBH



Smart switch relay module that can be fitted behind a standard wall switch plate and connects to a momentary push button mechanism

FEATURES

- 5 wire connection for power, load and momentary push button mechanism
- Reliable Bluetooth® mesh network connectivity to all KASTA devices
- 8-way multiway control
- Short press for ON/OFF control
- Thermal current overload protection
- Supports core KASTA functionality - control devices, groups, scenes, timers and scheduling
- Suits all Australian standard wall plates using a momentary mechanism
- iOS and Android app setup and control
- 3 year warranty

SPECIFICATIONS

Power Supply	220-240V a.c. 50Hz
Operating Ambient Temperature	-20 to 40°C
IP Rating	IP20
Thermal Derating	25 to 40°C (2400W-1200W)
Physical Connection Type	Terminals
Wiring Connections	Active, Neutral, Load & Momentary Mechanism
Momentary Input (T1/T2)	Local signal input only (not 240V a.c.) Max. wiring length between T1/T2 and momentary mechanism is 10m
LED Load Wattage	2W to 2400W
Multi-gang Derating	2-1800W, 3-1320W @ 25°C
Housing Material	Polycarbonate (PC)
Standards Complied	CoS SAA 183649, AS/NZS 60669.2.1, AS/NZS 60669.1, AS/NZS CISPR 15, AS/NZS 4268

Relay Surface Socket

KBSKTR2400



Smart socket plug base that can be ceiling or surface mounted

FEATURES

- Max. load 2400W or 100W motor
- Suits 3 pin plug
- Reliable Bluetooth® mesh network connectivity to all KASTA devices
- Energy monitoring function
- Can connect up to multiple circuits (within rated power rating)
- LED status indicator
- Reset button
- IPA stud provision for circuit identification
- Supports core KASTA functionality - control devices, groups, scenes, timers and scheduling
- Striking colour for easy identification in roof space
- Transparent nail plate for easy inspection of connections
- Multiple fixing points including external tabs for cable ties, clouts and screws
- Combination Flat & Philips terminal head screws
- Terminals to accept up to 4 x 2.5mm² cables
- iOS and Android app setup and control
- 3 year warranty

SPECIFICATIONS

Power Supply	220-240V a.c. 50Hz
Operating Ambient Temperature	-20 to 40°C
IP Rating	IP20
Thermal Derating	40 to 60°C (2400W-1200W)
Wiring Connections	Neutral, Earth, Active, Load, Loop
Load Wattage	2400W, 10A*, M.40
Housing Material	Polycarbonate (PC)
Standards Complied	AS/NZS 3112, AS/NZS 3100, AS/NZS 60669.2.1, AS/NZS 60669.1, AS/NZS CISPR 15

Dimmer Mechanism

KASTA-DM300BH-W



Smart push button dimmer mechanism that clips into standard wall plate

FEATURES

- Mains powered phase cut trailing edge (TE) dimmer
- 2-wire connection for easy installation
- Slim design allows installation up to 6-gang onto a standard wall plate
- Reliable Bluetooth® mesh network connectivity to all your KASTA devices
- 8-way multiway control
- Short press for ON/OFF control
- Long press for dimming control
- Over-current protection
- Supports core KASTA functionality - control devices, groups, scenes, timers and scheduling
- Suits most Australian wall plates
- Supplied with White button caps (2 x styles)
- iOS and Android app setup and control
- 3 year warranty

SPECIFICATIONS

Power Supply	220-240V a.c. 50Hz
Operating Ambient Temperature	-20 to 40°C
IP Rating	IP20
Thermal Derating	25 to 40°C (300W-100W)
Physical Connection Type	Fly leads
Wiring Connections	Active & Load
LED Load Wattage	3W* - 300W**
Dimming Method	Phase Cut Trailing Edge
Dimming Range	2-100%
Multi-gang Derating	2-270W, 3-240W, 4-200W, 5-150W, 6-100W @ 25°C
Housing Material	Polycarbonate (PC)
LED Indicators	Blue
Standards Complied	AS/NZS 60669.2.1, AS/NZS 60669.1, AS/NZS CISPR 15, AS/NZS 4268

*May require load correct capacitor if less than 15W (supplied in box).

**Maximum load is based on Haneco Dimmable LED drivers. Other LED loads may not be compatible. Contact the manufacturer for compatibility advice.

Dimmer Module

KASTA-D300IBH



Smart dimmer module that can be fitted behind a standard wall switch plate and connects to a momentary push button mechanism

FEATURES

- Phase cut trailing edge (TE) dimmer
- 5-wire connection for power, load and momentary push button mechanism
- Reliable Bluetooth® mesh network connectivity to all KASTA devices
- 8-way multiway control
- Short press for ON/OFF control
- Long press for dimming control
- Over-current protection
- Supports core KASTA functionality - control devices, groups, scenes, timers and scheduling
- Suits all Australian standard wall plates using a momentary mechanism
- iOS and Android app setup and control
- 3 year warranty

SPECIFICATIONS

Power Supply	220-240V a.c. 50Hz
Operating Ambient Temperature	-20 to 40°C
IP Rating	IP20
Thermal Derating	25 to 40°C (300W-165W)
Physical Connection Type	Terminals
Wiring Connections	Active, Neutral, Load & Momentary Mechanism
Momentary Input (T1/T2)	Local signal input only (not 240V a.c.) Max. wiring length between T1/T2 & momentary mechanism is 10m
LED Load Wattage	2W to 300W
Dimming Method	Phase Cut Trailing Edge
Dimming Range	2-100%
Multi-gang Derating	2-225W, 3-165W @ 25°C
Housing Material	Polycarbonate (PC)
Standards Complied	CoS SAA 183649, AS/NZS 60669.2.1, AS/NZS 60669.1, AS/NZS CISPR 15, AS/NZS 4268

Dimmer Surface Socket

KBSKTD350



Smart dimmer socket plug base that can be ceiling or surface mounted

FEATURES

- Max. load 350W
- Suits 3 pin plug
- Reliable Bluetooth® mesh network connectivity to all KASTA devices
- Can connect up to multiple circuits (within rated power rating)
- LED status indicator
- Reset button
- IPA stud provision for circuit identification
- Supports core KASTA functionality - control devices, groups, scenes, timers and scheduling
- Striking colour for easy identification in roof space
- Transparent nail plate for easy inspection of connections
- Multiple fixing points including external tabs for cable ties, clouts and screws
- Combination Flat & Philips terminal head screws
- Terminals to accept up to 4 x 2.5mm² cables
- iOS and Android app setup and control
- 3 year warranty

SPECIFICATIONS

Power Supply	220-240V a.c. 50Hz
Operating Ambient Temperature	-20 to 40°C
IP Rating	IP20
Thermal Derating	40 to 60°C (350W-250W)
Wiring Connections	Neutral, Earth, Active, Load & Loop
LED Load Wattage	350W, 1.4A*
Dimming Method	Phase Cut Trailing Edge
Dimming Range	2-100%
Housing Material	Polycarbonate (PC)
Standards Complied	AS/NZS 3112, AS/NZS 3100, AS/NZS 60669.2.1, AS/NZS 60669.1, AS/NZS CISPR 15

*Maximum load is based on Haneco Dimmable LED drivers. Other LED loads may not be compatible.

1-10V Dimmer

D1-10VIBH



Smart 1-10V dimmer for dimming control of LED highbay lighting

FEATURES

- 1-10V dimmer (suits luminaires with 1-10V input control)
- Used in combination with the KASTA 1-10V Daylight Sensor for daylight harvesting control of LED highbays
- Reliable Bluetooth® mesh network connectivity to all KASTA devices
- 8-way multiway control
- High temperature rated
- IP65 rated
- Over-temperature protection
- Includes 2m flex and plug lead
- Installed onto an LED highbay using the HANECO Multi-purpose Sensor Bracket (product code: SENSOR-BRKT)
- iOS and Android app setup and control
- 3 year warranty

SPECIFICATIONS

Power Supply	220-240V a.c. 50/60Hz
Operating Ambient Temperature	-20 to 50°C
IP Rating	IP65
Physical Connection Type	3-pin plug, Fly Leads
No Load Standby Power	<1W
Wiring Connections	Active, Neutral, Earth (3-pin plug), 1-10V Dimmer Output & Momentary Mechanism
Momentary Input (T1/T2)	Local signal input only (not 240V a.c.)
Maximum Output Current	40mA
Maximum Number of Drivers	30
Dimming Method	1-10V Dimming
Dimming Range	0-100%
Weight	355g
Housing Material	Polycarbonate (PC)
Standards Complied	AS/NZS 60669.2.1, AS/NZS 60669.1, AS/NZS CISPR 15, AS/NZS 4268

1-10V Daylight Sensor

SL02AB-BH



Smart daylight sensor that works with the Smart 1-10V Dimmer for daylight harvesting control of LED highbay lighting

FEATURES

- Mains powered ambient daylight sensor
- Used in combination with the KASTA Smart 1-10V Dimmer for daylight harvesting control of LED highbays
- Reliable Bluetooth® mesh network connectivity with multiple Smart 1-10V dimmers for group control
- Use the KASTA app to disable the sensor for manual control of lighting via the app
- High temperature rated
- IP65 rated
- Includes 2m flex and plug lead
- Installed onto an LED highbay using the HANECO Multi-purpose Sensor Bracket (product code: SENSOR-BRKT)
- iOS and Android app setup and control
- 3 year warranty

SPECIFICATIONS

Power Supply	220-240V a.c. 50/60Hz
Operating Ambient Temperature	-20 to 50°C
IP Rating	IP65
Physical Connection Type	3-pin plug
No Load Standby Power	<1W
Wiring Connections	Active, Neutral & Earth (3-pin plug)
Maximum Operation Current	5mA
Maximum Number of paired KASTA 1-10V Dimmers	10
Weight	255g
Housing Material	Polycarbonate (PC)
Standards Complied	AS/NZS 60669.2.1, AS/NZS 60669.1, AS/NZS CISPR 15, AS/NZS 4268

RGBTW Downlight

KB12RGBTWD1-WH



Smart 5 channel colour RGB downlight (16M RGB & Tuneable White)

FEATURES

- RGB/Tuneable White downlight
- Reliable Bluetooth® mesh network connectivity to all KASTA devices
- 8-way multiway control
- ON/OFF/DIM* and button press functionalities from local button (driver) or KASTA remote switch devices
- Supports core KASTA functionality - control devices, groups, scenes, timers and scheduling
- Ø90mm hole cutout
- Average lifetime >50,000 hours
- iOS and Android app setup and control
- 3 year warranty

**KASTA RGB devices must not be connected to any Phase-Cut (Leading/Trailing Edge & Universal) dimmers.*

SPECIFICATIONS

Power Supply	220-240V a.c. 50/60Hz
Operating Ambient Temperature	-20 to 40°C
IP Rating	IP54 (front face)
Connection Type	1.2m flex and plug
Input Power	TW: 12W; RGB: 5W
CCT	2700K - 6500K (for White)
CRI	>80
PF	≥0.90
Lumen Output	2700K: 750lm 6500K: 850lm
Beam Angle	110°
Trim Colour	White
Optics	Polycarbonate Diffuser
Electrical	Class 2
Dimming Range	2-100%
Hole Cutout Size	Ø90mm
IC Rating	IC
Housing Material	Aluminium, Polycarbonate (PC)
Standards Complied	AS/NZS 60598.2.2, AS/NZS 60695.11.5

RGBTW 5m LED Strip Kit

KB36RGBTWS5M



Smart 5 channel colour RGB LED strip kit (16M RGB & Tuneable White)

FEATURES

- RGB/Tuneable White LED strip kit including driver with flex and plug, KASTA in-line controller and 5m LED strip
- Reliable Bluetooth® mesh network connectivity to all KASTA devices
- 8-way multiway control
- ON/OFF/DIM* and button press functionalities from local button (in-line controller) or KASTA remote switch devices
- Supports core KASTA functionality - control devices, groups, scenes, timers and scheduling
- Average lifetime >50,000 hours
- iOS and Android app setup and control
- 3 year warranty

**KASTA RGB devices must not be connected to any Phase-Cut (Leading/Trailing Edge & Universal) dimmers.*

SPECIFICATIONS

Rated Supply Voltage	24V
Operating Ambient Temperature	-20 to 50°C
IP Rating	IP65 - Strip, IP20 - Controller
Maximum Input Current	6A
Maximum Input Power	144W (5m)
CCT	2700K - 6500K (for White)
CRI	80
Lumen Output	2700K: 528lm 6500K: 721lm
Dimming Range	2-100%
Beam Angle	120°
IP Rating	IP20 (driver, in-line controller) IP54 (LED strip)
Total LEDs	60
Cut Intervals	100mm
Housing Material	Silicone sleeved
Standards Complied	AS/NZS 60669.2.1, AS/NZS 60598.2.1, AS/NZS 60598.1

RGBTW Globes

KB8RGBTWGE27

KB8RGBTWGB22



Smart 5 channel colour RGB globes (16M RGB & Tuneable White)

FEATURES

- RGB/Tuneable White LED globes
- Reliable Bluetooth® mesh network connectivity to all KASTA devices
- 8-way multiway control
- ON/OFF/DIM* functionalities via KASTA remote switch devices or KASTA app
- Supports core KASTA functionality - control devices, groups, scenes, timers and scheduling
- Average lifetime >15,000 hours
- iOS and Android app setup and control
- 2 year warranty

**KASTA RGB devices must not be connected to any Phase-Cut (Leading/Trailing Edge & Universal) dimmers.*

SPECIFICATIONS

Power Supply	220-240V a.c.
Operating Ambient Temperature	-20 to 40°C
IP Rating	IP20
Input Current	35mA
Input Power	8W
CCT	2700K - 6500K (for White)
CRI	≥80
PF	0.5
Lumen Output	2700K: 560lm 6500K: 850lm
Dimming Range	2-100%
Beam Angle	180°
Standards Complied	AS/NZS 62560, AS/NZS CISPR15, AS/NZS 4268

HESPERUS™ Series Powerpoint

H2PPHB

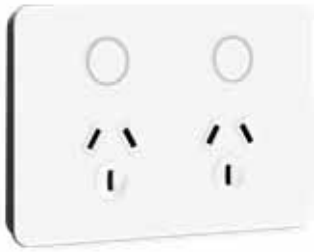

Double horizontal smart powerpoint

FEATURES

- Slim (10mm plate depth), contemporary, glass-look design with choice of 15 luxury colours
- Soft press push button operation with LED status indication
- UV stabilised to avoid discolouring
- Reliable Bluetooth® mesh network connectivity
- Short press for ON/OFF control
- Child lock enable/disable via local switch button or app
- Individual control and energy monitoring for each outlet
- Over current, over voltage, over temperature protection
- Auto-recovery if fault is removed (settings retained)
- Groups, scenes, timers and scheduling functionalities
- Fits standard first fix mounting accessories (e.g. C-clips, nail brackets, wall boxes)
- Flush mounting centres (not recessed) for quicker installation
- Backed off terminal screws and deep tunnels allow fast fitment of cables
- Multiple mounting facilities at both 84mm and 100mm, along with corner fixing points
- Insulated screw caps hinged to the grid plate to provide IP2X rating on mounting screws
- Colour coded terminals for ease of identification
- iOS and Android app setup and control
- 3 year warranty

SPECIFICATIONS

Power Supply	220-250V a.c.
Operating Ambient Temperature	-20 to 40°C
IP Rating	IP20
Current Rating	10A
Energy Monitor	0.01A to 10A
Plate Depth	10mm
Terminal Size	16mm ² (accommodates 4x2.5mm ² cables)
Terminal Screw Type	Combination Flat/Philips head
Mounting Points	84mm / 100mm and Corners
Mounting Screw Type	Combination Flat/Philips head
Frame Colour / Finish	White Matte / Black Matte
Plate Colour / Finish	15 colours, Transparent
Housing Material	Acrylic / Polycarbonate (PC)
LED Indicators	Blue (ON) / Green (Child Lock)
Standards Complied	CoS SAA 183650, AS/NZS 60669.2.1, AS/NZS 60669.1, AS/NZS CISPR 15, AS/NZS 4268

EDGY™ Series Powerpoint

KE2PPHB



Double horizontal smart powerpoint

FEATURES

- Slim (7.8mm plate depth), contemporary design
- Soft press push button operation with LED status indication
- UV stabilised to avoid discolouring
- Reliable Bluetooth® mesh network connectivity
- Short press for ON/OFF control
- Child lock enable/disable via local switch button or app
- Individual control and energy monitoring for each outlet
- Over current, over voltage, over temperature protection
- Auto-recovery if fault is removed (settings retained)
- Groups, scenes, timers and scheduling functionalities
- Fits standard first fix mounting accessories (e.g. C-clips, nail brackets, wall boxes)
- Flush mounting centres (not recessed) for quicker installation
- Backed off terminal screws and deep tunnels allow fast fitment of cables
- Multiple mounting facilities at both 84mm and 100mm, along with corner fixing points
- Insulated screw caps hinged to the grid plate to provide IP2X rating on mounting screws
- Colour coded terminals for ease of identification
- iOS and Android app setup and control
- 3 year warranty

SPECIFICATIONS

Power Supply	220-250V a.c.
Operating Ambient Temperature	-20 to 40°C
IP Rating	IP20
Current Rating	10A
Energy Monitor	0.01A to 10A
Plate Depth	7.8mm
Terminal Size	16mm ² (accommodates 4x2.5mm ² cables)
Terminal Screw Type	Combination Flat/Philips head
Mounting Points	84mm / 100mm and Corners
Mounting Screw Type	Combination Flat/Philips head
Plate Colour / Finish	White Gloss / Black Matte
Housing Material	Acrylic / Polycarbonate (PC)
LED Indicators	Blue (ON) / Green (Child Lock)
Standards Complied	CoS SAA 183650, AS/NZS 60669.2.1, AS/NZS 60669.1, AS/NZS CISPR 15, AS/NZS 4268

Curtain Control Module

KASTA-C300IBH



Smart curtain control module that can be fitted behind a standard wall switch plate and connects to a momentary push button mechanism

FEATURES

- Control AC powered motors (4-wire switched motor) or DC powered motors (Class I or Class II)
- 7-wire connection for power, motor and momentary switch mechanism
- Reliable Bluetooth® mesh network connectivity to all KASTA devices
- 8-way multiway control
- Short press on input S1 or S2 to fully OPEN or CLOSE, a second short press to STOP/PAUSE
- Long press (S1, S2) >2s will initiate movement until released
- Built-in over-voltage and over-current protection, with maximum 30 second run time
- Supports core KASTA functionality - control devices, groups, scenes, timers and scheduling
- Suits all Australian standard wall plates using a momentary mechanism
- iOS and Android app setup and control
- 3 year warranty

SPECIFICATIONS

Power Supply	220-240V a.c. 50Hz
Operating Ambient Temperature	-20 to 40°C
IP Rating	IP20
Physical Connection Type	Terminals
Wiring Connections	Active, Neutral, Motor (Open/Close) & Momentary Mechanisms
Load Output (Inductive) Max.	300W (1.2A)
Load Compatibility	AC Motor: Standard bidirectional 4-wire 240VAC single phase motor with internal limit switches (2 Active, 1 Neutral, 1 Earth) DC Motor: Class I or Class II equipment only, up to 24VDC (max.) with internal limit switches
Momentary Input (S1/S2)	Local signal input only (not 240V a.c.) Max. wiring length between S1/S2 and momentary mechanism is 10m
Housing Material	Polycarbonate (PC)
Standards Complied	AS/NZS 60669.2.1, AS/NZS 60669.1, AS/NZS 60950.1, AS/NZS CISPR 15, AS/NZS 4268

Dry Contact Output Module

KASTA-S10IBH



Smart dry contact output module for the connection to and control of third-party equipment

FEATURES

- Supports Pulse and Toggle control modes with ON/AUTO OFF and ON/OFF options
- Suitable for interconnection with Class I, Class II or Class III equipment
- 5-wire connection for power, load and switch mechanism (momentary or toggle)
- 4 output modes - 1s, 6s and 9s pulse ON (auto OFF) and toggle ON/OFF - default setting is 1s pulse
- Control third party equipment such as garage doors, motorised gates, irrigation systems etc.
- Reliable Bluetooth® mesh network connectivity to all KASTA devices
- 8-way multiway control
- Short press (or toggle) on input S1 or S2 to activate ON state
- Built-in over-voltage protection, with maximum 30 second run time
- Supports core KASTA functionality - control devices, groups, scenes, timers and scheduling
- Suits all Australian standard wall plates using a momentary or toggle mechanism
- iOS and Android app setup and control
- 3 year warranty

SPECIFICATIONS

Power Supply	220-240V a.c. 50Hz
Operating Ambient Temperature	-20 to 50°C
IP Rating	IP20
Physical Connection Type	Terminals
Wiring Connections	Active, Neutral, Load & Switch Mechanisms
Load Output Max.	2400W
Load Compatibility	0 to 240V a.c. 0 to 30V d.c.
Housing Material	Polycarbonate (PC)
Standards Complied	AS/NZS 60669.2.1, AS/NZS 60669.1, AS/NZS 60950.1, AS/NZS CISPR 15, AS/NZS 4268

Remote Switch 5-Input Module

KASTA-5RSIBH



Smart remote switch input module for the wireless control of KASTA devices from a wall switch with momentary mechanism or from a traditional 240V a.c. motion sensor

FEATURES

- All 5 inputs support 2 modes of operation - toggle input and momentary switch input
- Toggle input mode - used with toggle switch mechanisms, the load output from a sensor or relay output from another source (e.g. Assa Abloy® VingCard® system)
- Momentary switch input - used with momentary switch mechanism (short press and long press) or momentary relay output from another source
- Reliable Bluetooth® mesh network connectivity to all KASTA devices
- 8-way multiway control
- Built-in over-voltage protection
- Supports core KASTA functionality - control devices, groups, scenes, timers and scheduling
- Suits all Australian standard wall plates using a momentary or toggle mechanism
- iOS and Android app setup and control
- 3 year warranty

SPECIFICATIONS

Power Supply	220-240V a.c. 50Hz
Operating Ambient Temperature	-20 to 50°C
IP Rating	IP20
Physical Connection Type	Terminals
Wiring Connections	Active, Neutral, Momentary Mechanism or Sensor Load Output
Input Voltage (S1-S5)	240V a.c.
Housing Material	Polycarbonate (PC)
Standards Complied	AS/NZS 60950.1, AS/NZS CISPR 15, AS/NZS 4268

AC Ceiling Fan Controller

KASTA-FC150A



Smart AC ceiling fan controller providing capacitor switched 3-speed control of a fan plus ON/OFF fan light control

FEATURES

- Control of AC powered ceiling fan motors (max. 150W motor load)
- Contains relay for ON/OFF control of fan light (max. 300W load)
- Provides capacitor switching for 3-speed control of fan speed
- 7-wire connection for power, fan, light and momentary switch mechanisms
- Reliable Bluetooth® mesh network connectivity to all KASTA devices
- 8-way multiway control
- Short press on input S1 to toggle fan light, short press on input S2 to toggle fan and fan speed
- Long press on input S2 to cycle through fan speeds (Low>Medium>High, High>Medium>Low)
- Built-in over-voltage and over-current protection
- Supports core KASTA functionality - control devices, groups, scenes, timers and scheduling
- Easily installed in the hangsure bracket under the fan canopy
- iOS and Android app setup and control
- 3 year warranty

SPECIFICATIONS

Power Supply	220-240V a.c. 50Hz
Operating Ambient Temperature	-20 to 40°C
IP Rating	IP20
Physical Connection Type	Fly leads
Wiring Connections	Active, Neutral, Fan Motor, Fan Light, Momentary Mechanisms
Load Output Maximum	Fan: 150W (0.6A) Light: 300W (1.2A)
Load Compatibility	3-speed capacitor switched 240V a.c. ceiling sweet fan motor*, with or without inbuilt light
Housing Material	Polycarbonate (PC)
Standards Complied	AS/NZS 60669.2.1, AS/NZS 60669.1, AS/NZS CISPR 14.1, AS/NZS CISPR 15, AS/NZS 4268

*Minor variations in the speed of the fan may be evident when compared to the original controller, with differences also possible between the same model of fans.

Mechanism Button Caps

White Standard



Black Standard



Pictogram (32 options)



Square Style



Round Style



Adaptor Cap



A modern range of mechanism button caps are available to suit KASTA mechanisms for use in KASTA Unison™ switch plates as well as other commonly used plates from brands such as Clipsal®, HPM® and Legrand®



Complementing architectural aesthetics with smart components whilst matching traditional electrical fittings, ensuring consistency in look and design throughout the building, residence or dwelling.

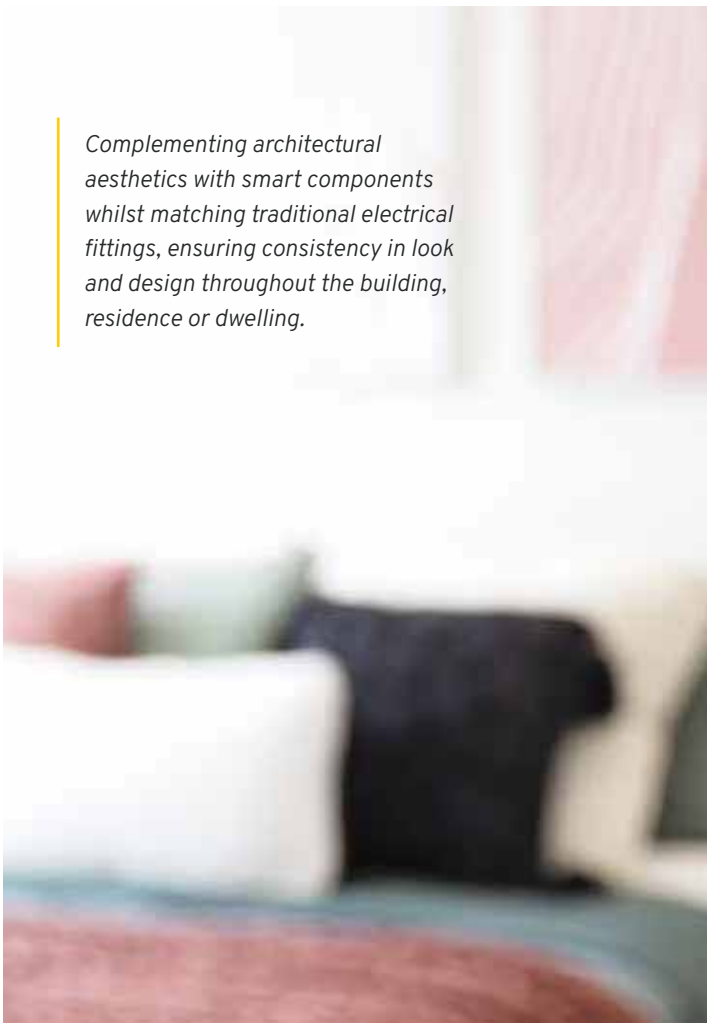

KASTA

Living Enhanced

Puro G2^{MS}

STANDARDS



The PURO G2 MS is a range of LED oyster lights providing Tritone colour selection, smooth light distribution and a flicker-free technology. This light is perfect for indoor residential applications.

- Tritone selectable - 3000K, 4000K, 5000K
- Durable white powder coated steel base
- Available in 250mm, 300mm and 400mm
- Opal twist lock diffuser makes installation easy
- Integral flicker free driver (*non-sensor versions*)
- Emergency (EM) versions available

SPECIFICATIONS

PURO G2 MS

POWER	LUMEN	lm/W	CCT	WEIGHT	SAP CODE	PRODUCT CODE
15W	1210lm	80lm/W	3000K	0.90kg	2001986	PURO15W300R-MS
	1370lm	91lm/W	4000K			
	1340lm	89lm/W	5000K			
25W	2140lm	85lm/W	3000K	0.70kg	2001990	PURO25W400R-MS
	2420lm	97lm/W	4000K			
	2330lm	93lm/W	5000K			
25W	2140lm	85lm/W	3000K	1.10kg	2001991	PURO25W-EM-MS
	2420lm	97lm/W	4000K			
	2330lm	93lm/W	5000K			

* Standard and Emergency versions available.

APPLICATIONS

- Residential
- Hallways
- Stairwells
- Porches
- Interior ceilings
- Hospitality
- Utility Rooms

COLOUR AND VARIANTS



LIGHT OPTICS



Cut off at 120 degrees.

DIAGRAMS

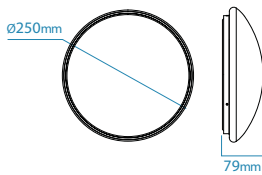

PURO 12W

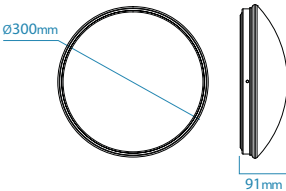

PURO 15W

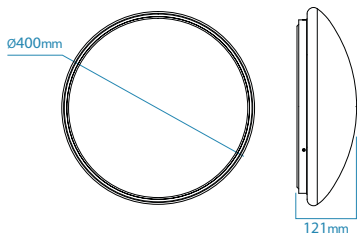

PURO 25W



Discus^{MS}



STANDARDS



The DISCUS MS is a sleek, aesthetically designed oyster light with slim body profile and IP54 protection rating that allows the fitting to be installed in both indoor and outdoor applications. It also comes in emergency (EM) versions.

- Tritone selectable - 3000K, 4000K, 5700K
- IP54 Protection for damp area installations
- Polycarbonate body and opal acrylic diffuser
- Robust vandal resistant construction
- External dip switches for sensor configuration
- Emergency (EM) versions available

SPECIFICATIONS

DISCUS MS

POWER	LUMEN	lm/W	CCT	WEIGHT	SAP CODE	PRODUCT CODE
25W	2040lm	81lm/W	3000K	1.0kg	2001937	DISC25W300R-MS
	2190lm	87lm/W	4000K			
	2080lm	83lm/W	5700K			
	2040lm	81lm/W	3000K	1.2kg	2001938	DISC25W-EM-MS
	2190lm	87lm/W	4000K			
	2080lm	83lm/W	5700K			

* Standard and Emergency versions available.

APPLICATIONS

- Retail
- Commercial
- Residential
- Colleges, Schools
- Offices
- Exterior Walls
- Under Eaves
- Stairwell

COLOUR AND VARIANTS



LIGHT OPTICS

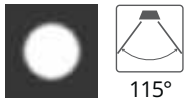

Cut off at 115 degrees.

DIAGRAMS

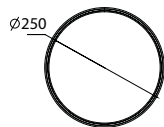

DISCUS 12W

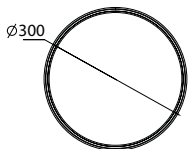

DISCUS 25W

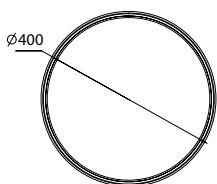

DISCUS 30W



Vista MS

STANDARDS



The VISTA MS is the perfect LED replacement for conventional battens. It enhances energy savings by offering efficiency and smart technology such as Intellisensor and Ecoswitch.

- Tritone selectable - 4000K, 4700K, 5700K
- Dual intensity selection with Ecoswitch (*non-sensor models*)
- Quick and easy installation
- 20mm cable entry, optional knockout and cables to suspend light while attaching the body
- Emergency (EM) versions available

SPECIFICATIONS

VISTA MS

NOMINAL LENGTH 1200mm (Standard mode)

POWER	LUMEN	lm/W	CCT	WEIGHT	SAP CODE	PRODUCT CODE
40W	4290lm	114lm/W	4000K	2.0kg	2002111	VISTA12-SS
	4700lm	122lm/W	4700K	2.5kg	2001065	VISTA40W12-TRI-SS-EM
	4730lm	112lm/W	5700K			

* Standard and Emergency versions available.

APPLICATIONS

- Retail
- Offices
- Schools
- Corridors
- Workshops
- Education

COLOURS



ACCESSORIES



Configuration Controller
BATTEN-REMOTE
SAP. 2002151
(Sensor Models)

LIGHT OPTICS

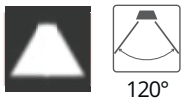

Cut off at 120 degrees.

DIAGRAMS

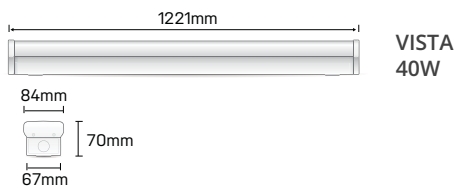

Vista hero MS



STANDARDS



The VISTA HERO MS is a conventional but elegant batten that is suitable for either new installations or as a replacement. 1230mm in length and 125mm in width, it is also available in Emergency (EM) versions.

- Tritone selectable - 4000K, 4700K, 5700K
- Quadruple power selection available (*non-sensor models*)
- Provides even and uniform light distribution
- White powder coated SPCC steel body
- Emergency (EM) versions available
- Smooth opal polycarbonate diffuser

SPECIFICATIONS

VISTA HERO MS

	POWER SETTING				CCT	EFFICACY
	40W	31W	26W	19W		
LUMEN OUTPUT	4420lm	3100lm	2700lm	2100lm	4000K	up to 117lm/W
	4580lm	3200lm	2800lm	2200lm	4700K	
	4290lm	3100lm	2700lm	2100lm	5700K	

VISTA HERO MS

MODEL LIST				
FEATURE	POWER SETTING	WEIGHT	SAP CODE	PRODUCT CODE
125mm Wide Body	40W	2.45kg	2001942	VISTA-HR12-MS
		2.55kg	2001943	VISTA-HR12-EM-MS

* Standard and Emergency versions available.

APPLICATIONS

- Residential retrofit
- Offices
- Garages
- Industrial
- Retail

COLOURS



LIGHT OPTICS



Cut off at 120 degrees.

DIAGRAMS

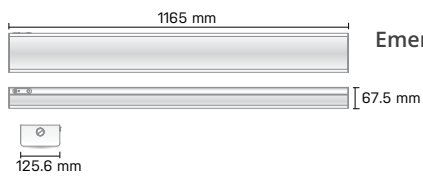

Emergency & Sensor VISTA^{hero}



Vista plus MS



STANDARDS



The VISTA PLUS MS is a premium wide body (110mm) LED batten with a stylish, smooth, satin polycarbonate diffuser. VISTA PLUS is also available in emergency (EM) versions.

- Tritone selectable - 4000K, 4700K, 5700K
- Elegant LED batten perfect for retrofit
- Powder coated SPCC steel body
- Provides even and uniform light distribution
- Flicker-free driver for softer light

SPECIFICATIONS

VISTA PLUS MS

	POWER SETTING	CCT	EFFICACY
	40W		
LUMEN OUTPUT	4700lm	4000K	up to 133lm/W
	5000lm	4700K	
	4700lm	5700K	

VISTA PLUS MS

MODEL LIST					
FEATURE	POWER SETTING	WEIGHT	SIZE	SAP CODE	PRODUCT CODE
110mm Wide Body	40W	2.40kg	1221mm	2001927	VISTA-PL12-MS
		2.60kg	1221mm	2001928	VISTA-PL12-EM-MS

* Standard and Emergency versions available.

APPLICATIONS

- Retail
- Office
- Industrial
- Commercial
- Car Parks

COLOURS



LIGHT OPTICS



115°x135°

Cut off at 115°x135° degrees.

DIAGRAMS

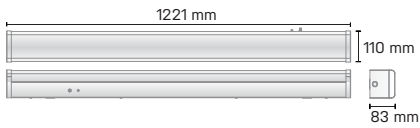

Emergency & Sensor VISTA^{plus}



Oxford MS

STANDARDS



The OXFORD MS is an extra wide body LED batten with an aesthetically pleasing low glare design minimising clutter on the ceiling for offices, retail and school applications.

- Tritone selectable - 4000K, 4700K, 5700K
- 4 power switchable (*non-sensor versions only*)
- Low glare design with flicker-free driver
- Quick and easy installation
- Emergency (EM) versions available
- Simple twist-lock end caps to secure diffuser

SPECIFICATIONS

OXFORD MS

	POWER SETTING	CCT	EFFICACY
	40W		
LUMEN OUTPUT	4200lm	4000K	up to 115lm/W
	4400lm	4700K	
	4200lm	5700K	

OXFORD MS

MODEL LIST					
FEATURE	POWER SETTING	WEIGHT	SIZE	SAP CODE	PRODUCT CODE
212mm Super Wide	40W	3.60kg	1220mm	2001887	OXFORD12-MS
		3.60kg	1220mm	2001888	OXFORD12-EM-MS

* Standard and Emergency versions available.

APPLICATIONS

- Colleges
- Schools
- Offices
- Retails

COLOURS



LIGHT OPTICS



Cut off at 120 degrees.

DIAGRAMS

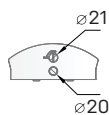

Triproof^{MS}



STANDARDS



The TRIPROOF MS outdoor LED battens feature a robust IK08 vandal resistant construction and are also available with Ecoswitch to minimise waste.

- Tritone selectable - 4000K, 5000K, 6500K
- Durable polycarbonate and UV stabilised
- Stainless steel tamper proof clips
- Vanda resistant construction
- PG16 cable entry with optional knockout
- Emergency (EM) versions available
- Quick and easy installation

SPECIFICATIONS

TRIPROOF MS

NOMINAL LENGTH 1200mm (Standard mode)

POWER	LUMEN	lm/W	CCT	WEIGHT	SAP CODE	PRODUCT CODE
40W	4510lm	113lm/W	4000K	2.0kg	2002112	TRIPROOF12-SS
	3830lm	96lm/W	5000K	2.2kg	2001068	TRIPROOF40W 12-TRI-SS-EM
	3350lm	84lm/W	6500K			

* Standard and Emergency versions available.

APPLICATIONS

- Outdoor
- Industrial
- Sport Halls
- Public Amenities

COLOURS



ACCESSORIES



Configuration Controller
BATTEN-REMOTE
SAP. 2002151
(Sensor Models)

LIGHT OPTICS



Cut off at 120 degrees.

DIAGRAMS

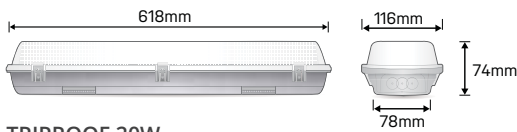

TRIPROOF 20W

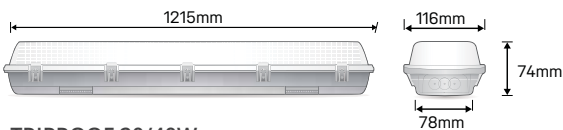

TRIPROOF 20/40W

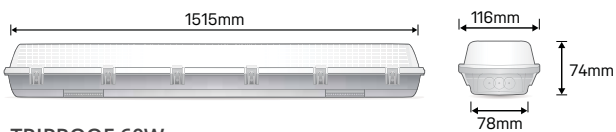

TRIPROOF 60W



Duralite^{MS}



STANDARDS



The DURALITE MS LED batten is ideal for use in utility-type applications such as car parks, workshops, storerooms and back of house areas. It features IP66 ingress protection and an impact resistance rating of IK09,

- Tritone selectable - 4000K, 4500K, 5000K
- Multi intensity weatherproof LED batten
- Anti-corrosive with stainless steel tamper proof clips
- Durable polycarbonate and UV stabilised
- Emergency (EM) versions available

SPECIFICATIONS

DURALITE MS

NOMINAL LENGTH 600mm

POWER	LUMEN	lm/W	CCT	WEIGHT	SAP CODE	PRODUCT CODE
20W	2024 / 2164 / 2069lm	105lm/W	4000K 4500K 5000K	1.05kg	2002002	DURALITE20W06-SS
18W	1800 / 1890 / 1800lm			1.30kg	2002003	DURALITE20W06-SS-EM
16W	1600 / 1680 / 1600lm					
15W	1500 / 1580 / 1500lm					
13W	1300 / 1350 / 1300lm					
12W	1200 / 1250 / 1200lm					

NOMINAL LENGTH 1200mm

POWER	LUMEN	lm/W	CCT	WEIGHT	SAP CODE	PRODUCT CODE
36W	4160 / 4380 / 4250lm	125lm/W	4000K 4500K 5000K	2.40kg	2002005	DURALITE35W12-SS-EM
30W	3750 / 3800 / 3730lm			2.00kg	2001499	DURALITE18/36W12-S
25W	3130 / 3150 / 3100lm					
18W	2720 / 2740 / 2680lm					

* Standard and Emergency versions available.

APPLICATIONS

- Outdoor
- Industrial
- Sport Halls
- Public Amenities

COLOURS



LIGHT OPTICS

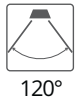

Cut off at 120 degrees.

DIAGRAMS

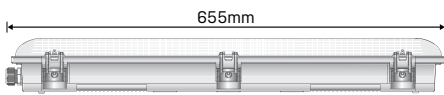

DURALITE 20W

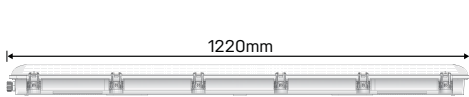
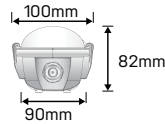

DURALITE 18/36W

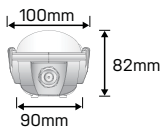

Drivers

Replacement lighting

LEDs can outlast drivers. Most LED failures are not from the LED itself, but from the driver instead. Therefore, you do not have to throw out a perfectly good luminaire when there is a simple solution.



*Featured:
FLEXION DRIVER*





Drivers



Replacement LED drivers

LEDs can outlast drivers. Don't throw out a perfectly good luminaire when there is a simple solution.

DOWNLIGHT - DIMMABLE DRIVER

COMPATIBLE	SPECIFICATION	SAP CODE	PRODUCT CODE
OVL14W145R OVL18W165R OVL20W200R	Haneco Phase-Cut Power Switchable Dimmable 8-15W Driver with Flex Plug and JST Connector	2002159	HD-15-JST-PS
ASTRO25W195R HELIX20W195R HELIX30W225R OVL30W230R	Haneco Phase-Cut Power Switchable Dimmable 15-25W Driver with Flex Plug and JST Connector	2002160	HD-25-JST-PS
ASTRO30W230R HELIX40W275R	Haneco Phase-Cut Dimmable 30W Driver with Flex Plug and JST Connector	2002161	HD-30-JST

OYSTER - DIMMABLE DRIVER

COMPATIBLE	SPECIFICATION	SAP CODE	PRODUCT CODE
PURO 300	Dimmable 7-21W Driver Constant Current 350mA 20-60V	2001217	HN-0721W-0350 DIMMABLE
PURO 400 PLUTO 400	Dimmable 9-28W Driver Constant Current 600mA 21-42V	2001218	HN-0928W-0600 DIMMABLE

BATTEN - DIMMABLE DRIVER

COMPATIBLE	SPECIFICATION	SAP CODE	PRODUCT CODE
VISTA 20/40W 1200mm	Dimmable 20-40W Driver Constant Current 700mA 28-58V	2000896	HN-1440W-0700 DIMMABLE
TRIPROOF 20/40W 1200mm	Dimmable 20-40W Driver Constant Current 700mA 28-58V	2000896	HN-1440W-0700 DIMMABLE
TRIPROOF 20/40W 1200mm	Dimmable 28-42W Driver Constant Current 700mA 40-60V	2000288	HN-1950W-0700



PANEL - NON DIMMABLE DRIVER (FLICKER-FREE)

COMPATIBLE	SPECIFICATION	SAP CODE	PRODUCT CODE
MATRIX 300 x 300mm MATRIX 300 x 600mm	Flicker-Free 18W MATRIX G3 Driver 450mA with Flex Plug and G3 DC Connector	2001992	HN-1318W-0450-FF
MATRIX 300 x 1200mm MATRIX 600 x 600mm	Flicker-Free 25/28/32/36W MATRIX G3 Driver 1000mA with Flex Plug and G3 DC Connector	2002092	HN-5680W-1000-FF
MATRIX 600 x 1200mm	Flicker-Free 48W MATRIX G3 Driver 1200mA with Flex Plug and G3 DC Connector	2001995	HN-5680W-1200-FF

PANEL - DIMMABLE DRIVER

COMPATIBLE	SPECIFICATION	SAP CODE	PRODUCT CODE
MATRIX 300 x 300mm MATRIX 300 x 600mm	Haneco Phase-cut Dimmable Constant Current 20W Driver 500mA with Flex Plug and G3 DC Connector	2002157	HD-20-DC
MATRIX 300 x 1200mm MATRIX 600 x 600mm MATRIX 600 x 1200mm	Haneco Phase-cut Dimmable Constant Current 36W Driver 1050mA with Flex Plug and G3 DC Connector	2002158	HD-36-DC

PANEL - DALI DRIVER

COMPATIBLE	SPECIFICATION	SAP CODE	PRODUCT CODE
MATRIX 300 x 300mm MATRIX 300 x 600mm	MATRIX 11W-18W Power Switchable DALI Driver with Flex Plug and G3 DC Connector	2002147	HDALI-18-DC-PS
MATRIX 300 x 1200mm MATRIX 600 x 600mm MATRIX 600 x 1200mm	MATRIX 22W-40W Power Switchable DALI Driver with Flex Plug and G3 DC Connector	2002148	HDALI-40-DC-PS
MATRIX 300 x 1200mm MATRIX 600 x 600mm MATRIX 600 x 1200mm	TRIDONIC Programmable Driver for MATRIX with Flex Plug and G3 DC Connector	2002164 2002163	HDALI-25-DC-TD HDALI-40-DC-TD



FLEXION LED STRIP - 12V DRIVER

SPECIFICATION	SAP CODE	PRODUCT CODE
FLEXION 12V Driver 0-75W 12V constant voltage	2000610	HN-0075-12V

FLEXION LED STRIP - 24V DRIVER

SPECIFICATION	SAP CODE	PRODUCT CODE
FLEXION 24V Driver 0-40W 24V constant voltage	2000918	HN-0040-24V
FLEXION 24V Driver 0-75W 24V constant voltage	2000988	HN-0075-24V-IP20
FLEXION 24V Driver 0-75W 24V constant voltage IP65	2000611	HN-0075-24V-IP65
FLEXION 24V Driver 0-100W 24V constant voltage IP67	2000613	HN-0100-24V
FLEXION 24V Driver 0-150W 24V constant voltage IP67	2000616	HN-0150-24V
FLEXION 24V Driver 0-240W 24V constant voltage IP67	2000265	HN-0240-24V

FLEXION LED STRIP - 24V DIMMABLE DRIVER

SPECIFICATION	SAP CODE	PRODUCT CODE
FLEXION 24V Dimmable Driver 0-25W 24V constant voltage	2000828	HD-0025-24V
FLEXION 24V Dimmable Driver 0-50W 24V constant voltage	2000829	HD-0050-24V
FLEXION 24V Dimmable Driver 0-200W 24V constant voltage IP67	2000830	HD-0200-24V

Surface Socket



- Compact size suits 90mm downlight holes
- Transparent nail plate to view connections
- Combination head terminal screws for Flat & Philips Screwdrivers
- Colour-coded & labelled terminals to assist cable terminations
- Multiple fixing points including external tabs for cable ties, clouts and screws

SPECIFICATIONS

FEATURES	Single Surface Socket, White 3 Pin, 10A, 250V a.c.
SAP CODE	2001933
PRODUCT CODE	SS310-WH

APPLICATIONS

- Residential
- Commercial

DIAGRAMS

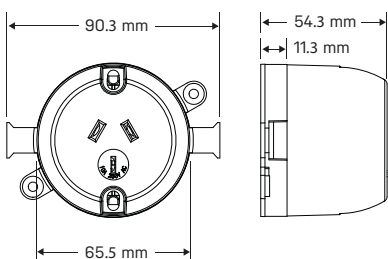

Downlight Housing



- Recessed downlight housing
- Suits downlights with 90-92mm cut-out
- Designed for installation within concrete structure

SPECIFICATIONS

FEATURES	Construction: Black ABS Weight: 200g
SAP CODE	2000865
PRODUCT CODE	CIS-DL110R

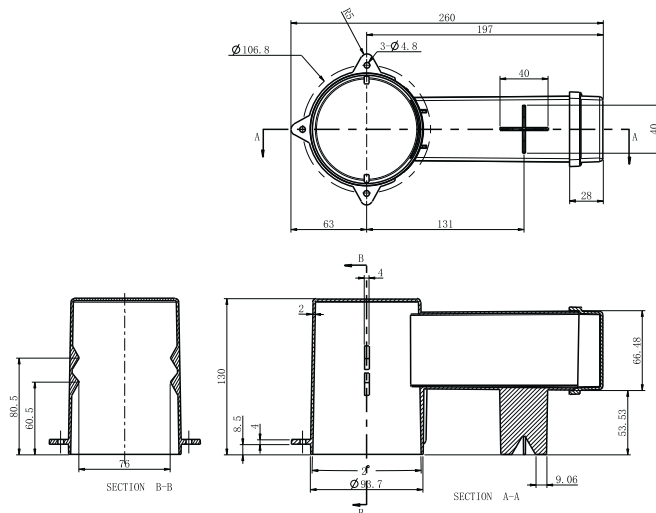



IP Rating







IP Rating

IP stands for Ingress Protection. It is a way of rating how well protected the device is from things that can get into it. The first number rating solid objects and dust from 1 to 6. The second figure is the water protection rating. The range is from 1 for slow dripping water from above up to 8 for a device that can be submerged.

First number: **Solid Objects**

- 
0 Not protected
- 
1 Protected against objects larger than 50mm
- 
2 Protected against objects larger than 12.5mm
- 
3 Protected against objects larger than 2.5mm
- 
4 Protected against objects larger than 1mm
- 
5 Dust protected. Protects ingress of dust sufficient to cause harm.
- 
6 Dust tight. No ingress of dust.

Second number: **Liquids**

- 
0 Not protected
- 
1 Protected against dripping water
- 
2 Protected against dripping water when tilted up to 15 degrees
- 
3 Protected against spraying water at an angle of up to 60 degrees
- 
4 Protected against splashing water from any direction
- 
5 Protected against jets of water from any direction
- 
6 Protected against heavy seas and powerful jets of water
- 
7 Protected against the effects of temporary immersion in water
- 
8 Protected against the effects of continuous immersion in water

IK Rating



IK Rating

The IK rating refers to impact protection. It is a 1 to 10 system with a higher number indicating a more robust product able to withstand a greater impact. IK10 can withstand a 4 litre tin of paint dropped on it from just under half a metre.

IK Code	Impact Energy (J)	Equivalent Impact
IK00	(no protection)	(no test)
IK01	0.14	Drop of 200g object from 7.5cm
IK02	0.2	Drop of 200g object from 10cm
IK03	0.3.5	Drop of 200g object from 17.5cm
IK04	0.5	Drop of 200g object from 25cm
IK05	0.7	Drop of 200g object from 35cm
IK06	1	Drop of 500g object from 20cm
IK07	2	Drop of 500g object from 40cm
IK08	5	Drop of 1700g object from 29.5cm
IK09	10	Drop of 5000g object from 20cm
IK10	20	Drop of 5000g object from 40cm

IC Rating

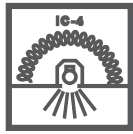

IC Rating

IC stands for 'insulation contact' and determines whether downlights can safely come into contact with potentially flammable material or with any covering that might interfere with the luminaire's cooling system.

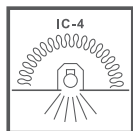

IC-4

- Suitable for residential or commercial use
- Fitting can be covered with building insulation
- Can be used where air transfer is not permitted or not desired between living space & roof space

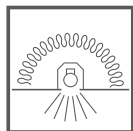

IC

- Suitable for residential or commercial use
- Fitting can be loosely covered with building insulation
- Can be used where some air transfer is permitted or desired between living space & roof

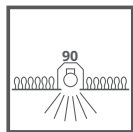

CA 90

- Suitable for residential or commercial use
- Fitting cannot be covered with building insulation
- Insulation can be placed against the sides of the fitting

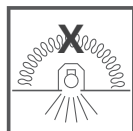

Do not cover

- Suitable for residential or commercial use in AU. Fitting cannot be covered with building insulation
- Insulation must be placed as per clearance distances according to manufactures installation guide

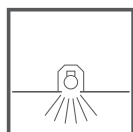

Non-IC

- Suitable for commercial use only
- Not suitable for use in residential dwellings or other places where insulation may be installed now or in the future
- Not tested for use with building insulation

Standards



Lumen

Lumens are a measure of the quantity of visible light emitted. The more lumens, the more light. Watts refers to the amount of energy consumed. LEDs have dramatically improved the conversion of power (watts) into visible light (lumens). A 60W LED now emits at least five times as much light as an old 60W incandescent bulb.



HACCP

HACCP Australia is a leading food science organisation that certifies products as food safe and appropriate for use in food production and food handling areas. For the latest updates on which Haneco products are certified, visit haneco.com.au/news/fresh-haccp-food-grade-approval/



Govt. Rebates

In the interests of reducing energy consumption in Victoria, New South Wales and South Australia the installation of approved new LED lighting is subsidised. The SA scheme is called REES, Victoria's is VEET and NSW has VEU (aka ESS). This effectively reduces the cost of installing energy efficient lights. For the latest updates on which Haneco products are certified, visit haneco.com.au/resources/government-schemes/



Our Locations



Western Australia
4/8 Tomlinson Rd
Welshpool, WA 6106
Ph: 1300 001 533

South Australia
262 Marion Rd
Netley, SA 5037
Ph: (08) 8297 6373

**Victoria and
Tasmania**
Building 8,
163-179 Forster Rd
Mount Waverley,
VIC 3149
Ph: (03) 9008 6109

**New South Wales
and ACT**
157 Orchardleigh St
Old Guildford,
NSW 2161
Ph: (02) 8999 1377

Queensland
72 Crockford St
Northgate, QLD 4013
Ph: (07) 3123 5008

GENERAL ENQUIRIES

info@haneco.com.au

Ph: (08) 8297 6373

1300 001 LED (533)

 [haneco.com.au](https://www.haneco.com.au)





1300 001 LED (533)

 haneco.com.au