



Representative Photo Only
(actual product may vary based on configuration selections)

Base For 4652 Relay Box Clamp w/Plastic Clip

- Complete range from PCB to power relays to cover all of your switching requirements
- Certifications and approvals including CE, EAC, PCT, RINA, VDE and RoHS, providing quality assurance of a market leading product.
- Compact construction allowing for most efficient use of space

SPECIFICATIONS

Product Series	46
Component Type Timers and Control relays	Relay Base
Height	32.8 mm
Width	29 mm
Depth	12.4 mm
Shock Acceleration (Max.)	20 g
Shock Duration (Max.)	4 ms
Vibration Acceleration (Max.)	20 m/s ²
Vibration Frequency, Operational (Max.)	150 Hz
Certifications	CE CCC CSA EAC GOST-R IMQ C-UR-US VDE
Shipping Approvals	Lloyd's Register of Shipping RINA (Registro Italiano Navale)



REFERENCES	
IECEX Certificate	-
Supplier Declaration of Conformity:	-
Installation Guide:	-
User Manual:	-
Manufacturer Datasheet:	-
Manufacturer Catalogue & Product Selection:	-

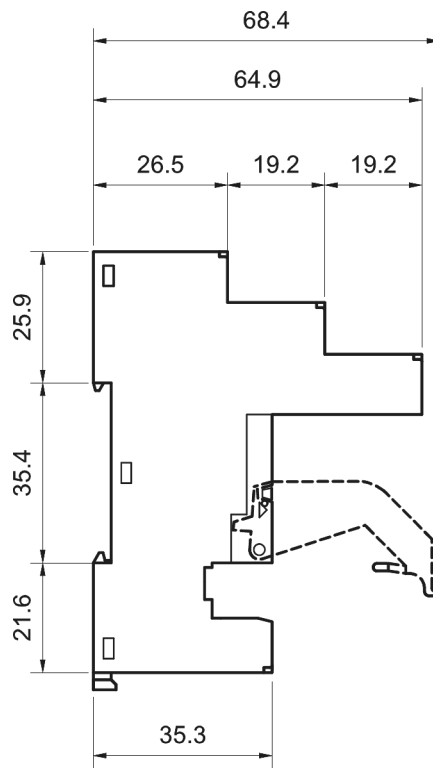

Dimension Diagram

Catalogue No: **97.02**

BASE FOR 4652 RELAY BOX CLAMP W/PLASTIC CLIP

Timers and Control Relays > General Purpose Relays > Electromechanical Relays > Finder Electromechanical Relays > PCB and Miniature Relays > 46 Series Miniature Industrial Relays

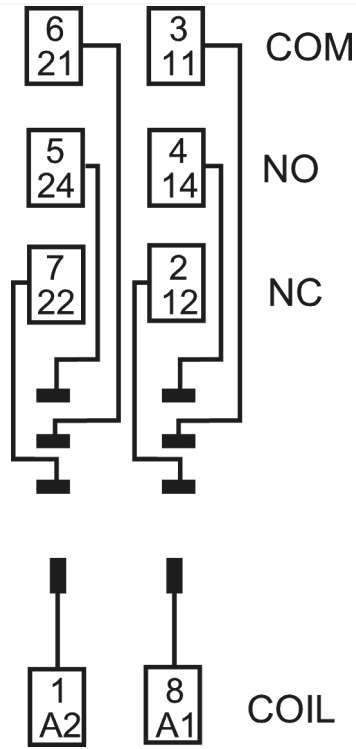

Connection / Wiring Diagram