

Section 21

Limit Switches

Encapsulated Miniature Industrial Snap Switches



9007MS



9007A

Modular, Miniature, and Compact



XCMD



XCKD



XCKP



XCKT

Compact General Duty



XCKL



9007C

Heavy Duty Industrial



9007C



XCKJ

Severe Duty



9007T



L100

Limit Switches	21-2
Application Data	21-4
Current Ratings	21-5
Industrial Snap Switches	21-6
Encapsulated Miniature	21-8
Osisense Limit Switches, Miniature, Metal	21-10
Osisense Limit Switches Metal and Plastic	21-12
Modular, Miniature, and Compact	21-13
Modular, Miniature and Compact Bodies	21-17
Light Duty Compact, Plastic, Non-Modular	21-18
XCKN and XCNR Complete Switches	21-18
Light Duty Industrial, Standard Body, Plastic	21-19
XC Standard Range, Format EN 50041	21-20
XCKS, Plastic, Double Insulated	21-20
Complete Switches with 1 Cable Entry	21-20
Variable Composition Switches with 1 Cable Entry	21-21
Variable Composition Switches—Bodies and Accessories	21-22
OsiSense XCKW	21-23
XCKW Wireless and Batteryless Limit Switches	21-23
Network Access Points	21-24
Accessories	21-25
Osisense Limit Switches XC Standard, Classic	21-26
Compact General Duty	21-28
Osisense Limit Switches, Standard Industrial, Metal	21-30
Heavy Duty / Industrial Metal Body	21-32
Heavy Duty Industrial Metal Plug-in Body	21-36
Heavy Duty Industrial Single- and Two-Pole	21-38
Severe Duty, Oiltight, Mill and Foundry	21-43

Product Panorama 1 of 2
Refer to Catalog 9006CT1007

Design	Miniature				Compact		
Catalog number	9007 A/O	9007 MS/ML	XCMN	XCMD	XCKP	XCKD	XCKL
Page	Industrial Snap Switches, page 21-6	Heavy Duty, page 21-8	Precabled, Non-Modular, page 21-14	Precabled, Modular, page 21-14	Plastic, page 21-14	Metal, page 21-14	General Duty, page 21-28
							
Enclosure	Open, plastic	Metal body, metal head	Plastic, double insulated	Metal	Plastic, double insulated	Metal	Metal
Features	A variety of operators are available.	Bottom or side cable entry. Full range of operating heads. See page 21-8.	Mounting by the body or by the head				1 conduit entry
Modularity	Selected operators	Operator	—	Head, body, lever, and connector			Head, body, and lever
Conforming to standards	—	—	—	—	CENELEC: EN 50047		—
Body dimensions (w x h x d), mm (in.)	29.0 x 63.5 x 21.0 (1.14 x 2.5 x 0.83)	40.1 x 44.4 x 15.8 (1.58 x 1.75 x 0.62)	30 x 50 x 16 (1.18 x 1.97 x 0.63)		31 x 65 x 30 (1.22 x 2.56 x 1.18)		52 x 72 x 30 (2.05 x 2.83 x 1.18)
Head	Linear	Linear or rotary	Linear movement, plunger Rotary movement, lever Rotary movement, multi-directional [1] Same heads for ranges XCMD, XCKD, XCKP and XCKT				Linear movement, plunger. Rotary movement, lever. Rotary movement, multi-directional. [1]
Contact blocks							
2 snap action contacts ⊕	—	—	N.C. + N.O.	N.C. + N.O.; N.C. + N.C.	N.C. + N.O.; N.C. + N.C.	N.C. + N.O.; N.C. + N.C.	N.C. + N.O.
2 snap action contacts	—	—	N.C. + N.O.	N.C. + N.O.; N.C. + N.C.	N.C. + N.O.; N.C. + N.C.	N.C. + N.O.; N.C. + N.C.	N.C. + N.O.
3 snap action contacts ⊕	—	—	—	N.C. + N.C. + N.O.	N.C. + N.C. + N.O.; N.C. + N.O. + N.O.	N.C. + N.C. + N.O.; N.C. + N.O. + N.O.	N.C. + N.C. + N.O.; N.C. + N.O. + N.O.
3 snap action contacts	—	—	—	N.C. + N.C. + N.O.	N.C. + N.C. + N.O.; N.C. + N.O. + N.O.	N.C. + N.C. + N.O.; N.C. + N.O. + N.O.	N.C. + N.C. + N.O.; N.C. + N.O. + N.O.
4 snap action contacts ⊕	—	—	—	N.C. + N.C. + N.O. + N.O.	—	—	—
4 snap action contacts	—	—	—	N.C. + N.C. + N.O. + N.O.	—	—	—
2 slow break contacts ⊕ break before make	—	—	—	N.C. + N.O.	N.C. + N.O.	N.C. + N.O.	N.C. + N.O.
2 slow break contacts ⊕ break before make	—	—	—	N.C. + N.O.	N.C. + N.O.	N.C. + N.O.	N.C. + N.O.
2 slow break contacts ⊕ make before break	—	—	—	—	N.O. + N.C.	N.O. + N.C.	N.O. + N.C.
2 slow break contacts ⊕ make before break	—	—	—	—	N.O. + N.C.	N.O. + N.C.	N.O. + N.C.
2 slow break contacts ⊕ simultaneous	—	—	—	—	N.C. + N.C.	N.C. + N.C.	N.C. + N.C.
2 slow break contacts ⊕ simultaneous	—	—	—	—	N.O. + N.O.	N.O. + N.O.	N.O. + N.O.
3 slow break contacts ⊕ break before make	—	—	—	N.C. + N.C. + N.O.	N.C. + N.C. + N.O.; N.C. + N.O. + N.O.	N.C. + N.C. + N.O.; N.C. + N.O. + N.O.	N.C. + N.C. + N.O.; N.C. + N.O. + N.O.
3 slow break contacts ⊕ break before make	—	—	—	N.C. + N.C. + N.O.	N.C. + N.C. + N.O.; N.C. + N.O. + N.O.	N.C. + N.C. + N.O.; N.C. + N.O. + N.O.	N.C. + N.C. + N.O.; N.C. + N.O. + N.O.
2 snap action contacts	N.C. + N.O., N.O. + N.O.	N.C. + N.O.	—	—	—	—	—
4 snap action contacts	N.C. + N.C., N.O. + N.O.	—	—	—	—	—	—
Insulation voltage (Ui) / thermal current (Ithe)	See page 21-10	300 Vac/Vdc 10 A (standard)	Screw terminal 2 contacts: 400 V / 6 A	Pre-cabled 2 contacts: 400 V / 6 A 3 contacts: 400 V / 4 A 4 contacts: 400 V / 3 A	Screw terminal: 2 contacts: 500 V / 10 A 3 contacts: 400 V / 6 A Connector: Integral M12, 4-pin: 250 V / 3 A	Screw terminal: 2 contacts: 500 V / 10 A 3 contacts: 400 V / 6 A Connector: Integral M12, 5-pin: 60 V / 4 A	Screw terminal: 2 contacts: 500 V / 10 A 3 contacts: 400 V / 6 A
Enclosure rating IP = IEC enclosure rating IK = EN shock test standard	None	NEMA Types 1, 2, 4, 6, 6P, 12, 13 IP67	NEMA Types 1, 2, 13 IP65, IK04	NEMA Types 1, 2, 4X, 6, 12 IP66, IP67, IP68, IK06	NEMA Types 1, 2, 4, 6, 6P, 12, 13 IP66, IP67, IK04	NEMA Types 1, 2, 4, 6, 12, 13 IP66, IP67, IK06	NEMA Types 1, 2, 4, 6, 6P, 12, 13 IP66, IK06
Electrical connection	Screw terminal or Faston® connector	Pre-wired cable or M12 connector	Pre-wired cable	Pre-cabled. Connector: Integral or remote M12 or remote 7/8" 16UN	Screw terminal: M16, M20, Pg 11, Pg 13, 1/2" NPT, or PF 1/2 Connector: Integral M12	Screw terminal: M16, M20, Pg 11, Pg 13, 1/2" NPT, or PF 1/2 Connector: Integral M12	Screw terminal: M20 or 1/2" NPT

21 LIMIT SWITCHES

[1] Flexible operators do not guarantee direct (positive) opening operation.

Product Panorama 2 of 2
Refer to Catalog **9006CT1007**

Design	Standard Duty Industrial				Severe Duty Mill and Foundry	
Catalog number	9007C	XCKJ	XCKS	XCKW	9007T/FT	L100/L300
Page	Standard and Compact, page 21-38	Fixed or Plug-in Body, page 21-38	Double Insulated, page 21-19	Wireless, Batteryless, page 21-23	Convertible Sequences, page 21-42	Fixed Sequences, page 21-45
						
Enclosure	Metal, diecast, zinc alloy	Metal	Plastic, double insulated	Plastic	Metal	Metal
Features	Plug-in body	Optional low or high temperature versions	—	—	Extra heavy duty contact ratings	—
Modularity	Head, body, and lever			Bodies and heads		Lever
Conforming to standards / Product certifications	UL 508, C22-2-14-95, NEMA 250, IEC 60947, EN 60947-1, EN 60947-5-1	CENELEC: EN 50041	CENELEC: EN 50041	EN/IEC 60947-5, EMC 2004/108/EC directive, R&TTE 1999/5/EC directive, CE	NEMA A600 UL508 UL Listed, CSA Certified	NEMA A600 UL508 UL Listed, CSA Certified
Body dimensions w x h x d, mm (in.)	Standard: 39 x 102 x 45 (1.54 x 4.02 x 1.77) Compact: 39 x 80 x 45 (1.54 x 3.15 x 1.77)	40 x 77 x 44 (1.57 x 3.03 x 1.73) 42.5 x 84 x 36 (1.67 x 3.31 x 1.42)	40 x 72.5 x 36 (1.57 x 2.85 x 1.42)	width: 1.57 (40)	58.7 x 114.3 x 64.5 (2.31 x 4.5 x 2.54)	58.7 x 126 x 53.3 (2.31 x 4.95 x 2.10)
Head	Linear movement, plunger Rotary movement, lever Multi-directional movement (wobble stick, cat whisker) [2]	Linear movement, plunger Rotary movement, lever Rotary movement, multi-directional [2]	Linear movement, plunger Rotary movement, lever Rotary movement, multi-directional [2]	Linear movement, plunger Rotary movement, lever Rotary movement, multi-directional [2]	Rotary movement, lever	Rotary movement, lever
Contact blocks						
2 snap action contacts →	—	N.C. + N.O.; N.C. + N.C.	N.C. + N.O.; N.C. + N.C.	—	—	Various options for L100, 2- and 3-pole
2 snap action contacts	—	N.C. + N.O.; N.C. + N.C.	N.C. + N.O.; N.C. + N.C.	—	—	—
3 snap action contacts →	—	N.C. + N.C. + N.O.; N.C. + N.O. + N.O.	N.C. + N.C. + N.O.; N.C. + N.O. + N.O.	—	—	—
3 snap action contacts	—	N.C. + N.C. + N.O.; N.C. + N.O. + N.O.	N.C. + N.C. + N.O.; N.C. + N.O. + N.O.	—	—	—
4 snap action contacts →	—	—	—	—	—	—
4 snap action contacts	—	—	—	—	—	—
2 slow break contacts break before make →	—	N.C. + N.O.	—	—	—	—
2 slow break contacts break before make	—	N.C. + N.O.	—	—	—	—
2 slow break contacts make before break →	—	N.O. + N.C.	—	—	—	—
2 slow break contacts make before break	—	N.O. + N.C.	—	—	—	—
2 slow break contacts simultaneous →	—	N.C. + N.C.	—	—	—	—
2 slow break contacts simultaneous	—	N.O. + N.O.	N.O. + N.O.	—	—	—
3 slow break contacts break before make →	—	N.C. + N.C. + N.O.; N.C. + N.O. + N.O.	N.C. + N.C. + N.O.; N.C. + N.O. + N.O.	—	—	—
3 slow break contacts break before make	—	N.C. + N.C. + N.O.; N.C. + N.O. + N.O.	N.C. + N.C. + N.O.; N.C. + N.O. + N.O.	—	—	—
1 slow break contact Form Y1561 [3]	1 N.C.	—	—	—	—	—
2 snap action contacts	1 N.O. + 1 N.C.	2 C/O	2 C/O	—	1 N.C. + 1 N.O. [4] convertible sequence	1 N.C. + 1 N.O. [4] some convertible
4 snap action contacts	2 N.O. + 2 N.C.; 2 N.O. + 2 N.C., neutral position; 2 N.O. + 2 N.C., two stage	—	—	—	—	—
Insulation voltage (Ui) and thermal current (Ithe)	Ui: 600 V, except 9007C62, 9007C66, 9007C88 (Ui = 250 V) and 9007C84, 9007C86 (Ui: 125 V). Ithe: 10 A, except 9007C84, 9007C86 (Ithe: 2.5 A)	Screw terminal 2 contacts: 500 V / 10 A 3 contacts: 400 V / 6 A Connector: Integral M12, 5-pin: 60 V / 4 A; Integral 7/8" 16UN: 250 V / 6 A	Screw terminal 2 contacts: 500 V / 10 A 3 contacts: 400 V / 6 A	600 V 20 A (AC/DC)	600 V 20 A (AC), 5 A (DC)	
Enclosure rating IP = IEC enclosure rating IK = EN shock test standard	IP67 conforming to IEC 60529; NEMA Types 2, 4, 6, 6P, 12, 13	NEMA Types 1, 2, 4, 12; IP66, IK07	IP65, IK03	IP66 and IP67 conforming to EN/IEC 60529; IK05 conforming to EN/IEC 50102	NEMA Types 1, 2, 4, 12, 13 IP65, 66, 67	NEMA Types 1, 4, 13 IP65, 66
Electrical connection	Cable entry: 1/2"-14 NPT; M20 x 1.5 ISO cable entry. Connector: Integral 5-pin mini-connector	Screw terminal: M20 x 1.5, PG13, or 1/2" PT Connector: Integral M12 or 7/8" 16UN	Screw terminal: M20 x 1.5 or PG13	—	Cable entry: 1/2" NPT or PG13.5	Cable entry: 1/2" NPT or 3/4" NPT. Other options available Connector: 7/8" 16UN or Cannon MS3102E20-AP or equal; other options available

[2] Flexible operators do not guarantee direct (positive) opening operation.

[3] Single pole only. Refer to page 21-35 for details.

[4] For other contact options, see catalog 9006CT1007.

Application Data for All Limit Switch Types

Table 21.1: Enclosure Ratings

Type	NEMA Style												IEC Style		
	1	2	3	4	4X	6	6P	7	9	12	13	IP65	IP66	IP67	
▲ Indicates NEMA or IEC Type Rating available for each product															
9007C	▲	▲	▲	▲	▲	▲	▲	▲	▲	▲	▲	▲	▲	▲	
9007CR	▲	▲	▲	▲	▲	▲	▲	▲	▲	▲	▲	▲	▲	▲	
9007FT	▲	▲	▲	▲	▲	▲	▲	▲	▲	▲	▲	▲	▲	▲	
L100/L300	▲	▲	▲	▲	▲	▲	▲	▲	▲	▲	▲	▲	▲	▲	
9007MS/ML [1]	▲	▲	▲	▲	▲	▲	▲	▲	▲	▲	▲	▲	▲	▲	
9007T	▲	▲	▲	▲	▲	▲	▲	▲	▲	▲	▲	▲	▲	▲	
XCKJ	▲	▲	▲	▲	▲	▲	▲	▲	▲	▲	▲	▲	▲	▲	
XCKL	▲	▲	▲	▲	▲	▲	▲	▲	▲	▲	▲	▲	▲	▲	
XCKN & XCNR	▲	▲	▲	▲	▲	▲	▲	▲	▲	▲	▲	▲	▲	▲	
XCKP & XCKT [2]	▲	▲	▲	▲	▲	▲	▲	▲	▲	▲	▲	▲	▲	▲	
XCKS, XCMN	▲	▲	▲	▲	▲	▲	▲	▲	▲	▲	▲	▲	▲	▲	
XCMD, XCKD	▲	▲	▲	▲	▲	▲	▲	▲	▲	▲	▲	▲	▲	▲	

Table 21.2: Ambient Temperature Ranges

Type	Low Temperature	High Temperature at Full Rated Load
9007 C		
Lever Type	-20 °F (-28.9 °C)	+185 °F (+85 °C)
Plunger & Wobble Stick Type	0 °F (-17.8 °C)	+185 °F (+85 °C)
9007 FT [3], T	-10 °F (-23 °C)	+185 °F (+85 °C)
HL100/HL300	0 °F (-17.8 °C)	+350 °F (+177 °C)
L100/L300	0 °F (-17.8 °C)	+200 °F (+93 °C)
9007 MS/ML	-4 °F (-20 °C)	+221 °F (+105 °C)
XCKJ, XCKL, XCKP, XCKT	-13 °F (-25 °C)	+158 °F (+70 °C)
XCMN, XCKN, XCNR	-13 °F (-25 °C)	+158 °F (+70 °C)
XCKS	-13 °F (-25 °C)	+158 °F (+70 °C)
XCMD	-13 °F (-25 °C)	+158 °F (+70 °C)

Some switches are available with higher or lower temperature limits, by selecting special versions or special options. Refer to the respective product sections for further information.
(Ex.: 9007MS/ML, see page 21-9.)

Table 21.3: Sealing

Type	Material
Standard shaft seals on lever types	Fluorocarbon rubber (FKM)
9007C, CR	
Plunger and wobble stick boots	Neoprene; Fluorocarbon optional
All other seals	Nitrile (Buna N); Fluorocarbon optional
R.B.Denison™ L	PVC
9007T and FT	
Shaft seal	Nitrile (Buna N)
Cover gasket	Nitrile (Buna N)
Base plate gasket	Cellulose fiber laminate
XCKJ, XCKL, XCKS	Nitrile (Buna N)
XCMD, XCKD, XCKP, XCKT, XCKN, XCNR	Nitrile (Buna N) and silicon

Table 21.4: Electrical Contact Ratings

V	AC—NEMA A600					DC			
	Max. Current—35% Power Factor					Maximum Current			
	Make	Break	Continuous Carrying Amperes			Make or Break	Continuous Carrying Amperes		
	A	VA	A	VA		A	VA		
120	60	7200	6	720	10	125	1.1/0.55 [4]	138/69 [4]	5/2.5 [4]
240	30	7200	3	720	10	—	—	—	—
480	15	7200	1.5	720	10	250	0.27	67.5	2.5
600	12	7200	1.2	720	10	600	0.10	60	2.5

Table 21.5: Contact Function Diagrams

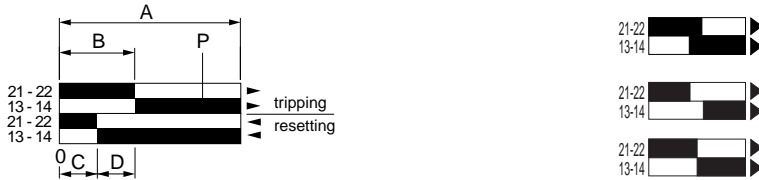

A=Maximum travel of the operator in mm or degrees.
B=Tripping travel of the contact.
C=Reset travel.
D=B-C=Differential travel.
P=Point from which positive opening is assured

Make-before-break (overlapping) SPDT
The normally open contact closes before the normally closed contact opens.
Break-before-make (offset) SPDT
The normally closed contact opens before the normally open contact closes.
Simultaneous make and break—SPDT
The normally closed contact opens at the same time as the normally open contact closes.

Table 21.6: Wiring Diagrams

Form A	Form B	Form C	Form AA	Form BB	Form CC	Form X	Form Y	Form Zb	Form Z	Form XX	Form YY	Form ZZ
SPST-NO	SPST-NC	SPDT	DPST-NO	DPST-NC	DPDT	SPST-NO-DB	SPST-NC-DB	SPDT-DB Isolated Contacts	SPDT-DB	DPST-NO-DB	DPST-NC-DB	DPDT-DB

[1] Enclosure ratings are NEMA 1, 2, 3, 4, 6, 6P, 12, and 13 except for option 21 (low force) which is NEMA 1 only. The 9007 MS/ML05 (omni-directional operation) enclosure ratings are NEMA 1, 2, 12, and 13

[2] For indoor use only—not UV protected.

[3] The Type FT will withstand hot falling sand up to +300°F (+149 °C); however, ambient temperature for the FT switch is the same as the Type T above (+185 °F, +85 °C). Do not use in higher temperature ambients.

[4] Type C52 compact unit ratings at 125 Vdc—same ratings as C54, CF53 and CR53 at other voltages.

Contact Configurations

Contact Configurations—Direct opening contacts meet IEC 60947-5-1 requirements. For contacts used in safety applications (end of travel, emergency stop device, etc.) the assurance of direct opening is required (see IEC 204, EN 60204, or NF C 79–130) after each test. The opening of the contact must be verified by testing with an impulse voltage (2500 V).

Table 21.7: Maximum Current Ratings for Control Circuit Contacts—All Types

Switch Type	Contacts	Direct Opening Contacts Meet IEC 60947-5-1 Requirements	AC—50 or 60 Hz						DC			AC/DC Continuous Carrying Amperes
			V	Inductive 35% Power Factor				Resistive 75% Power Factor Make and Break Amperes	Inductive and Resistive			
				Make		Break			Single Pole	Double Pole		
				A	VA	A	VA					
L100/L300	SPDT with 2 or 3 Contacts Form Z	No	120 240 480 600	150 75 37.5 30	18000 18000 18000 18000	20 12.5 6.25 5	2400 3000 3000 3000	6 3 1.5 1.2	125 250 600 —	1.1 0.55 0.2 —	—	20/5
XCKD 2 Contacts	SPDT Form Zb	Yes	120 240	60 30	7200 7200	6 3	720 720	6 3	125 250	0.55 0.27	—	10/2.5
XCKD 3 Contacts	3 Pole Form Zb	Yes	120 240	30 15	3600 3600	3 1.5	360 360	3 1.5	125 250	0.22 0.11	—	5/1.0
XCKJ Plug-in	SPDT Form Z	No	120 240	60 30	7200 7200	6 3	720 720	6 3	125 250	0.55 0.27	—	10
	2 SPDT Form ZZ	No	480 600	15 12	7200 7200	1.5 1.2	720 720	1.5 1.2	600 —	0.1 —	—	10 10
XCKJ Non-plug-in	SPDT Form Zb	Yes	120 240	60 30	7200 7200	6 3	720 720	6 3	125 250	0.55 0.27	—	10/2.5 10
	2 SPDT Form ZZ	No	120 240	60 30	7200 7200	6 3	720 720	6 3	125 250	0.55 0.27	—	10/2.5 10
XCKL	SPDT Form Zb	Yes	120 240	60 30	7200 7200	6 3	720 720	6 3	125 250	0.55 0.27	—	10
XCKN	2 Pole	Yes	120 240	60 30	7200 7200	6 3	720 720	6 3	125 250	0.55 0.27	—	10/2.5
XCKP 2 Contacts	SPDT Form Zb	Yes	120 240	60 30	7200 7200	6 3	720 720	6 3	125 250	0.55 0.27	—	10/2.5
XCKP 3 Contacts	3 Pole Form Zb	Yes	120 240	30 15	3600 3600	3 1.5	360 360	3 1.5	125 250	0.22 0.11	—	5/1.0
XCKT 2 Contacts	SPDT Form Zb	Yes	120 240	60 30	7200 7200	6 3	720 720	6 3	125 250	0.55 0.27	—	10/2.5
XCKT 3 Contacts	3 Pole Form Zb	Yes	120 240	30 15	3600 3600	3 1.5	360 360	3 1.5	125 250	0.22 0.11	—	5/1.0
XCMD 2-4 Contacts	2,3 or 4 Pole Form Zb	Yes	120 240	30 15	3600 3600	3 1.5	360 360	3 1.5	125 250	0.22 0.11	—	5/1.0
XCMN 2 Contacts	SPDT Form Zb	Yes	120 240	30 15	3600 3600	3 1.5	360 360	3 1.5	125 250	0.22 0.11	—	5/1.0
XCNR	2 Pole	Yes	120 240	60 30	7200 7200	6 3	720 720	6 3	125 250	0.55 0.27	—	10/2.5
9007AO1, AC	SPST, Form X or Y (rated 0.5 hp @ 110 and 200 Vac) SPDT, Form Z	No	120 240 480 600	40 20 10 8	4800 4800 4800 4800	15 10 6 5	1800 2400 2880 3000	15 10 6 5	125 250 600 —	0.5 0.25 0.05 —	0.25 0.1 — —	15
9007AO2, AO6, AB, AP	SPST, Form X or Y (rated 0.5 hp @ 110 and 200 Vac) SPDT, Form Z	No	120 240 480 600	40 20 10 8	4800 4800 4800 4800	15 10 6 5	1800 2400 2880 3000	15 10 6 5	125 250 600 —	2.0 0.5 0.1 —	0.5 0.2 0.02 —	15
9007CO3, CO6, CB, CC, CP	DPST Form AA or BB DPDT Form ZZ	No	120 240 480 600	30 15 7.5 6	3600 3600 3600 3600	3 1.5 0.75 0.6	360 360 360 360	3 1.5 0.75 0.6	125 250 600 —	1.0 0.3 0.1 —	0.2 0.1 — —	10
9007C	SPST Form Y1561 Slow break	Yes	120 240 480 600	60 30 15 12	7200 7200 7200 7200	6 3 1.5 1.2	720 720 720 720	6 3 1.5 1.2	125 250 600 —	0.55 0.27 0.1 —	—	10/2.5
	SPDT Form Z	No	120 240 480 600	60 30 15 12	7200 7200 7200 7200	6 3 1.5 1.2	720 720 720 720	6 3 1.5 1.2	125 250 600 —	0.55 0.27 0.1 —	0.22 0.11 — —	10/2.5
	DPDT Form ZZ	No	120 240 480 600	60 30 15 12	7200 7200 7200 7200	6 3 1.5 1.2	720 720 720 720	6 3 1.5 1.2	125 250 600 —	0.22 0.11 — —	0.22 0.11 — —	10/1.0
9007MS	SPDT Form C	No	120 240	60.0 30.0	7200 7200	6.0 3.0	720 720	—	—	—	—	10 (AC) / 5 (Res. @ 28 Vdc)
9007ML	SPDT Form Z	No	120 240	60.0 30.0	7200 7200	6.0 3.0	720 720	—	—	—	—	10 (AC) / 5 (Res. @ 28 Vdc)
9007T and FT	SPDT Quick Make and Break Form Z	No	120 240 480 600	150 75 37.5 30	18000 18000 18000 18000	20 12.5 6.25 5	2400 3000 3000 3000	20 12.5 6.25 5.0	125 250 600 —	5.0 1.0 0.2 —	—	20
	All Slow Make and Break Form Z	No	120 240 480 600	60 30 15 12	7200 7200 7200 7200	6 3 1.5 1.2	720 720 720 720	6 3 1.5 1.2	—	—	—	20

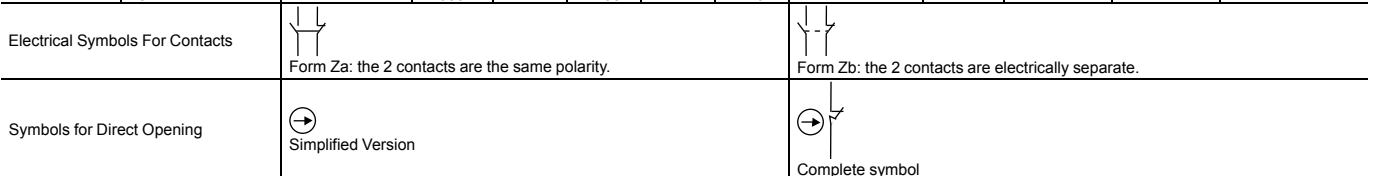

NOTE: Alternate Current Ratings—Several product lines offer special versions or options with alternate contact configurations or contact materials, which may result in current ratings that differ from those listed above. Refer to the respective product sections for further information.

Industrial Snap Switches Without Enclosures



Type AO2



Type AB21



Type AP222 with 2358C22G6 mushroom button

Industrial snap switches have been incorporated in many Square D products such as timers, specialty push buttons, foot switches, operating mechanisms, door interlocks, motor control centers, limit switches, and many other control products.

Recommended Actuator: An adjustable actuator is recommended. If nonadjustable actuator is used, a resilient type or a mechanical stop should be used to prevent "bottoming" of button mechanism.

Adjustable Actuator Overtravel: Minimum recommended overtravel in both trip and reset directions is 0.015 in.

Adjustable Actuator Total Travel: Maximum differential limit plus 0.030 in. (Example: 0.076 in. for Type AO2.)

Nonadjustable Actuator Total Travel: Fully retracted—at least 0.139 in. for Type AO1 and 0.160 in. for Types AO2 and CO3 from mounting surface. Fully engaged—at least 0.061 in. but not closer than 0.045 in. from mounting surface.

Contact Configurations: Single-pole snap switches that contain two double-break contact elements (1 N.O. and 1 N.C.) must be used on circuits of the same polarity. Double-pole snap switches contain two electrically separated sets of contact elements allowing use on circuits of opposite polarity. Each set contains two double-break contact elements (1 N.O. and 1 N.C.) that must be used on circuits of the same polarity.

Table 21.8: Quick Make and Break—600 Volts Max. AC and DC

Operator Style	Contact Arrangement	Type	Operator Style	Contact Arrangement	Type
Basic Snap Switch	1 N.O. 1 N.C.	AO1	Cabinet Door Style	1 N.O. 1 N.C.	AC1
	1 N.O.	AO1B		2 N.O. 2 N.C.	CC1
	1 N.O. 1 N.C.	AO2	Plunger Style Panel Mounting	1 N.O. 1 N.C.	AP221
	1 N.C. (Plug-in)	AO6 (Plug-in)		2 N.O. 2 N.C.	CP221
	1 N.C.	AO2A		Operator Only	AP201
	1 N.O.	AO2B			
	2 N.O. 2 N.C.	CO3	Roller Plunger Style Panel Mounting Non-Oiltight	1 N.O. 1 N.C.	AP321 [1]
	2 N.O.	CO6 (Plug-in)		2 N.O. 2 N.C.	CP321
Two Stage 2 N.O. 2 N.C.	CO7	Operator Only		AP301 [1] AP304 [2]	
Rigid Roller Lever Style	1 N.O. 1 N.C.	AB21 (RH) AB22 (LH)	Roller Plunger Style Panel Mounting Oiltight	1 N.O. 1 N.C.	AP323
	7/32" width roller	AB41 (without side mtg. bracket)		2 N.O. 2 N.C.	CP323
	1 N.O. 1 N.C.	AB23 (RH) AB24 (LH)	Operator Only		AP303 [1] AP305 [1][2]
	15/32" width roller	CB31 (RH)			
	2 N.O. 2 N.C.	CB41 (without side mtg. bracket)			
	7/32" width roller	CB33 (RH) CB34 (LH)			
	2 N.O. 2 N.C.	CB33 (RH) CB34 (LH)			
	15/32" width roller	CB34 (LH)			
Rigid Roller Lever Style One Way Roller	1 N.O. 1 N.C.	AB25 (RH)	Mushroom Button Style Panel Mounting	1 N.O. 1 N.C.	AP222

Table 21.9: Maximum Current Ratings For Control Contacts—All Types

Switch Type	Contacts [3]	AC—50 or 60 Hz						DC			AC or DC Continuous Carrying Amperes
		Voltage	Inductive 35% Power Factor				Resistive 75% Power Factor Make and Break Amperes	Voltage	Inductive and Resistive		
			Make		Break				Make and Break Amperes		
			A	VA	A	VA			Single Pole	Double Pole	
AO1, AC	SPDT	120	40	4800	15	1800	15	125	0.5	0.25	15
	Form Z	240	20	4800	10	2400	10	250	0.25	0.1	15
	SPST	480	10	4800	6	2880	6	600	0.05	—	15
	Form X or Y	600	8	4800	5	3000	5	—	—	—	15
AW, AO2, and AO6, AB, AP	SPDT	120	40	4800	15	1800	15	125	2.0	0.5	15
	Form Z	240	20	4800	10	2400	10	250	0.5	0.2	15
	SPST	480	10	4800	6	2880	6	600	0.1	0.02	15
	Form X or Y	600	8	4800	5	3000	5	—	—	—	15
AW, CO3, and CO6, CB, CC, CP	DPDT	120	30	3600	3	360	3	125	1.0	0.2	10
	Form ZZ	240	15	3600	1.5	360	1.5	250	0.3	0.1	10
	DPST	480	7.5	3600	0.75	360	0.75	600	0.1	—	10
	Form AA or BB	600	6	3600	0.6	360	0.6	—	—	—	10

Acceptable Wire Size 14–22 AWG
Recommended Terminal Clamp Torque 6–9 lb-in (0.7–1.0 N•m)



[1] For use with Type AO and CO basic switches.
[2] Roller turned 90° from standard (perpendicular to mounting holes).
[3] Do not meet IEC 60947–5–1 requirements for direct opening contacts

Approximate Dimensions and Operating Data, 9007AO, CO, AP, and CP

Approximate Dimensions and Operating Data, 9007AO, CO, AP, and CP

9007AO, Single-Pole Snap Switch

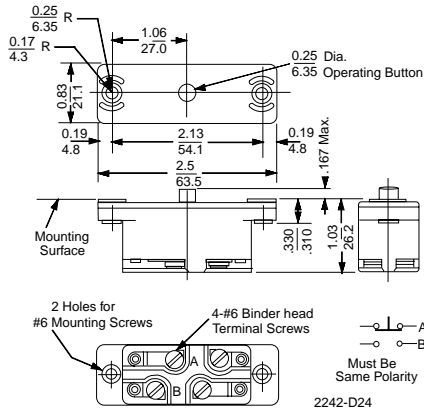

9007CO, Two-Pole Snap Switch

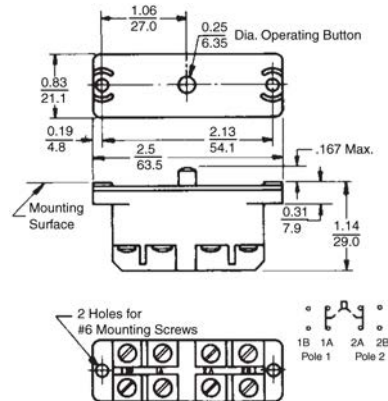

	Operating Data, in. (mm)	
	AO1, 1B	AO2, 2A, 2B
Pre-travel	0.057–0.074 (1.4–1.8)	0.057–0.074 (1.4–1.8)
Differential	0.015–0.025 (0.6–0.6)	0.035–0.046 (0.9–1.16)
Total travel	0.103–0.125 (2.6–3.2)	0.103–0.125 (2.6–3.2)
Operating force	7–11 oz (0.05–0.08 N)	10–14 oz (0.07–0.1 N)
Shipping weight	0.25 lb (0.11 kg)	0.25 lb (0.11 kg)

	Operating Data, in. (mm)	
	CO3	CO7
Pre-travel 1st stage	0.057–0.074 (1.4–1.8)	0.035–0.060 (0.9–1.5)
Pre-travel 2nd stage	—	0.060–0.085 (1.5–2.1) [4]
Differential	0.025–0.046 (0.6–1.16)	0.010–0.020 (0.25–0.50)
Total travel	0.103–0.125 (2.6–3.2)	—
Operating force	7–12 oz (0.05–0.084 N)	7–12 oz (0.05–0.084 N)
Shipping weight	0.25 lb (0.11 kg)	0.25 lb (0.11 kg)

9007AP201, 221, and CP221

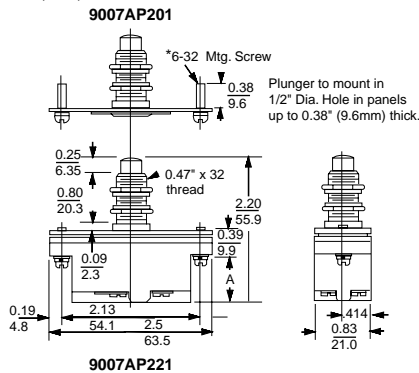

9007AP301, 303, 304, 305, 321, 323, 324, 325, and CP321, 323, 324, 325

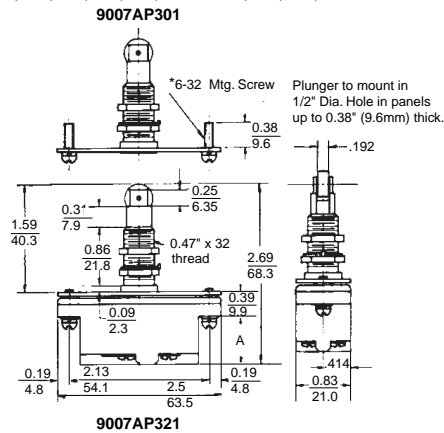

Type	Dimension A
AP221	0.70 (17.8)
CP221	0.80 (20.3)

	Operating Data, in. (mm)	
	AP221	CP221
Pretravel	0.070–0.089 (1.8–2.2)	0.070–0.089 (1.8–2.2)
Differential	0.035–0.046 (0.9–1.2)	0.025–0.046 (0.9–1.2)
Overtravel	0.161–0.180 (4.1–4.6)	0.161–0.180 (4.1–4.6)
Total travel	0.231–0.269 (5.8–6.8)	0.231–0.269 (5.8–6.8)
Operating force	10–14 oz (0.07–0.1 N)	7–12 oz (0.05–0.08 N)
Shipping weight	0.25 lb (0.11 kg)	0.25 lb (0.11 kg)

Type	Dimension A
AP321, 323, 324, 325	0.70 (17.8)
CP321, 323, 324, 325	0.80 (20.3)

	Operating Data, in. (mm)			
	AP321	AP323, 325	CP321	CP323
Pretravel	0.060–0.150 (1.5–3.8)	0.060–0.150 (1.5–3.8)	0.060–0.150 (1.5–3.8)	0.060–0.150 (1.5–3.8)
Differential	0.035–0.046 (0.9–1.2)	0.035–0.046 (0.9–1.2)	0.025–0.046 (0.9–1.2)	0.035–0.046 (0.9–1.2)
Total travel	0.200–0.340 (5.1–8.6)	0.200–0.340 (5.1–8.6)	0.200–0.340 (5.1–8.6)	0.200–0.340 (5.1–8.6)
Operating force	20 oz (0.14 N)	28 oz (0.2 N)	26 oz (0.18 N)	28 oz (0.2 N)

[4] Separation between first and second stage trip points is 0.020–0.025 (0.5–0.6).

Miniature MS Limit Switch



The heavy-duty, miniature MS limit switch is completely encapsulated and intended for difficult applications such as machine tools, earth moving equipment, and general transportation. 9007MS04S0084

The switch has 40 mm mtg hole centers.

MS Circuit—Form C	Electrical Ratings/SPDT Form C (MS Type)			
	Silver Contacts			Gold Contacts
1 N.O.—1 N.C.	Vac	Make	Break	
	120	60 A	6 A	
	240	30 A	3 A	
	10.0 Amperes Continuous			
DC Contact Rating: 5 A (Res), 28 Vdc				

ML Circuit—Form Z	Electrical Ratings/SPDT-DB Form Z (ML Type)		
	Silver Contacts		
1 N.O.—1 N.C.	Vac	Make	Break
	120	60 A	6 A
	240	30 A	3 A
	10.0 Amperes, Continuous		
DC Contact Rating: 5 A (Res), 28 Vdc			

Table 21.10: Specifications

Temperature range (The minimum temperatures listed are based on the absence of freezing moisture or water.)	-4 °F to +221 °F (-20 °C to +105 °C) For -40 °F / -40 °C minimum temperature, see Forms 21 and 80 on page 21-9.
Enclosure rating	NEMA 1, 2, 4, 6, 6P, 12, 13, IP67
Vibration resistance	10 G (75–1200 Hz)
Shock resistance	35 G
Contact Characteristics	
Rated thermal current	10 A (standard)
Rated insulation voltage	300 Vac and Vdc (standard)
Gold contact switching ratings	0.1A, 24 Vdc; 0.24 VA
Cable	#18 AWG SJTO

Table 21.11: Selection (append prefix 9007 to the catalog number)

Description / Functional Diagram [1]	MS	ML	Operating Force/Torque	Contact Form	Contact Type	Catalog Number [2]
Top plunger						
			80 oz	SPDT Form C	Silver	MS01S0100
			80 oz	SPDT Form C	Gold	MS01G0100
			80 oz	SPDT Form Z	Silver	ML01S0100
Parallel roller plunger						
			80 oz	SPDT Form C	Silver	MS02S0100
			80 oz	SPDT Form C	Gold	MS02G0100
			80 oz	SPDT Form Z	Silver	ML02S0100
Cross roller plunger						
			80 oz	SPDT Form C	Silver	MS03S0100
			80 oz	SPDT Form C	Gold	MS03G0100
			80 oz	SPDT Form Z	Silver	ML03S0100
Rotary lever, CW and CCW						
<p>Not included (see Table 21.14 on page 21-9)</p>			48 oz-in	SPDT Form C	Silver	MS04S0100
			48 oz-in	SPDT Form C	Gold	MS04G0100
			48 oz-in	SPDT Form Z	Silver	ML04S0100
Omnidirectional—wire whisker (NEMA 1, 2, 12, 13 only)						
			15 oz-in	SPDT Form C	Silver	MS05S0100
			15 oz-in	SPDT Form C	Gold	MS05G0100
Bushing mounted—top plunger						
			80 oz	SPDT Form C	Silver	MS06S0100
Bushing mounted—parallel roller plunger						
			80 oz	SPDT Form C	Silver	MS07S0100
			80 oz	SPDT Form C	Gold	MS07G0100
			80 oz	SPDT Form Z	Silver	ML07S0100
Bushing mounted—cross roller plunger						
			80 oz	SPDT Form C	Silver	MS08S0100
Adjustable top plunger						
			80 oz	SPDT Form C	Silver	MS09S0100
			80 oz	SPDT Form Z	Silver	ML09S0100



E78403
NKCR



LR 25490
3211-03



[1] If the application includes oil, booting switches are recommended. See page 21-9

[2] For available options and part number explanations, see page 21-9. Add options to the end of the catalog number. Up to three options may be added, if applicable.

Lever Arms and Options

Table 21.12: Selection—Booted Devices (append prefix 9007 to the catalog number)





Description / Functional Diagram	MS	ML	Operating Force/Torque	Contact Form	Contact Type	Catalog Number [3][4]
			80 oz	SPDT Form C	Silver	MS10S0100
			80 oz	SPDT Form C	Gold	MS10G0100
			80 oz	SPDT Form Z	Silver	ML10S0100
			80 oz	SPDT Form C	Silver	MS12S0100
			80 oz	SPDT Form Z	Silver	ML12S0100
			80 oz	SPDT Form C	Silver	MS13S0100

Table 21.13: Cable Length and General Options Designators: 9007MS01Sxxy

Replace xx and yy in the catalog number above with the designators in the tables below. Some combinations of cable lengths and options are unavailable; consult Schneider Electric.

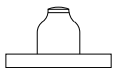
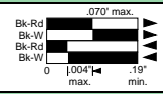
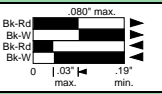

Cable Length (xx) [5]	Designator	General Options (yy) [3]	Designator
No cable [6]	00	#16 AWG SJTO cable (MS only)	02
3 ft—standard	01	Side entrance #18 AWG SJTO cable	06
6 ft	02	Gray #18 AWG SJTO cable	10
9 ft	03	Male 4 pin micro-connector in housing (DC type) (MS only)	54
12 ft	04	Male 5 pin micro-connector (DC type) (ML only)	55
18 ft	05	Low temperature (-40 °F / -40 °C), 9007MS04 (NEMA 1 only)	80
33 ft	13	Tapped holes in top of plunger housing (MS and ML)	81
		Male 4 pin micro-connector in housing (AC type) (MS only)	82
		Male 4-pin micro-connector in housing (AC type) (no cable)	84

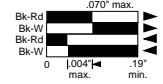
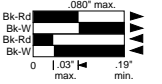
Table 21.14: Style 7 Levers—0.75 in. (19 mm) diameter, nylon or steel roller (9007 prefix is not required on lever catalog numbers)

Length		Catalog Number 1/4 in. (6 mm) Wide		Catalog Number 1/2 in. (13 mm) Wide		Catalog Number 3/4 in. (19 mm) Wide	Catalog Number 1 in. (25 mm) Wide
inch	(mm)	Nylon	Steel	Nylon	Steel	Nylon	Nylon
0.875	(22.23)	7A2N	7A2	7B2N	7B2	—	—
1.375	(34.93)	7A3N	—	7B3N	—	7F3N	—
1.5	(38.10)	7A1N	7A1	7B1N	—	7F1N	7J1N
1.75	(44.45)	7A7N	—	—	—	—	—
2.00	(50.8)	7A4N	—	7B4N	—	7F4N	7J4N

NOTE: Lever tightening torque for mounting the lever on the shaft: minimum **17 lb-in.**
Other levers available. See catalog 9006CT1007. For inside (reverse) roller option at no charge, replace 7 with 7X (for example: 7A2N changes to 7XA2N).

Table 21.15: Specialty Arms (9007 prefix is not required on lever catalog numbers)

Description	Catalog Number
Style 7D adjustable length 1-3/8" to 3-3/8"—0.75" diameter, 1/4" wide, metal roller	7D
Style 7DN adjustable length 1-3/8" to 3-3/8"—0.75" diameter, 1/4" wide, nylon roller	7DN
Style 7S spring nylon, 6" rod, 0.3" diameter	7S
Style 7N nylon rod, 5" long, 0.3" diameter	7N

NOTE: Lever tightening torque for mounting the lever on the shaft: minimum **17 lb-in.**

Male plug (face) pin-outs

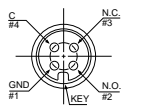

Option 54 (MS only)—DC

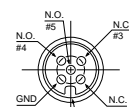

Option 55 (ML only)—DC

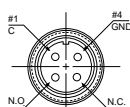

Option 12 (MS only)—AC or DC (3 Amps)

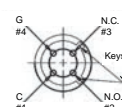

Option 82 (MS only)—AC

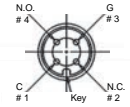

Option 84 (MS only)—AC

NOTE: DC connectors are rated 3 A, 250 Vac/Vdc.

[3] See available options below. Add to the end of the catalog number. Up to three options may be added, if applicable.
[4] This catalog number is for devices with a standard cable and no options. See page for other cable length selections and general options.
[5] See available options below. Add to the end of the catalog number. Up to three options may be added, if applicable.
[6] Use with options 54, 55, and 82.

Overview — Metal

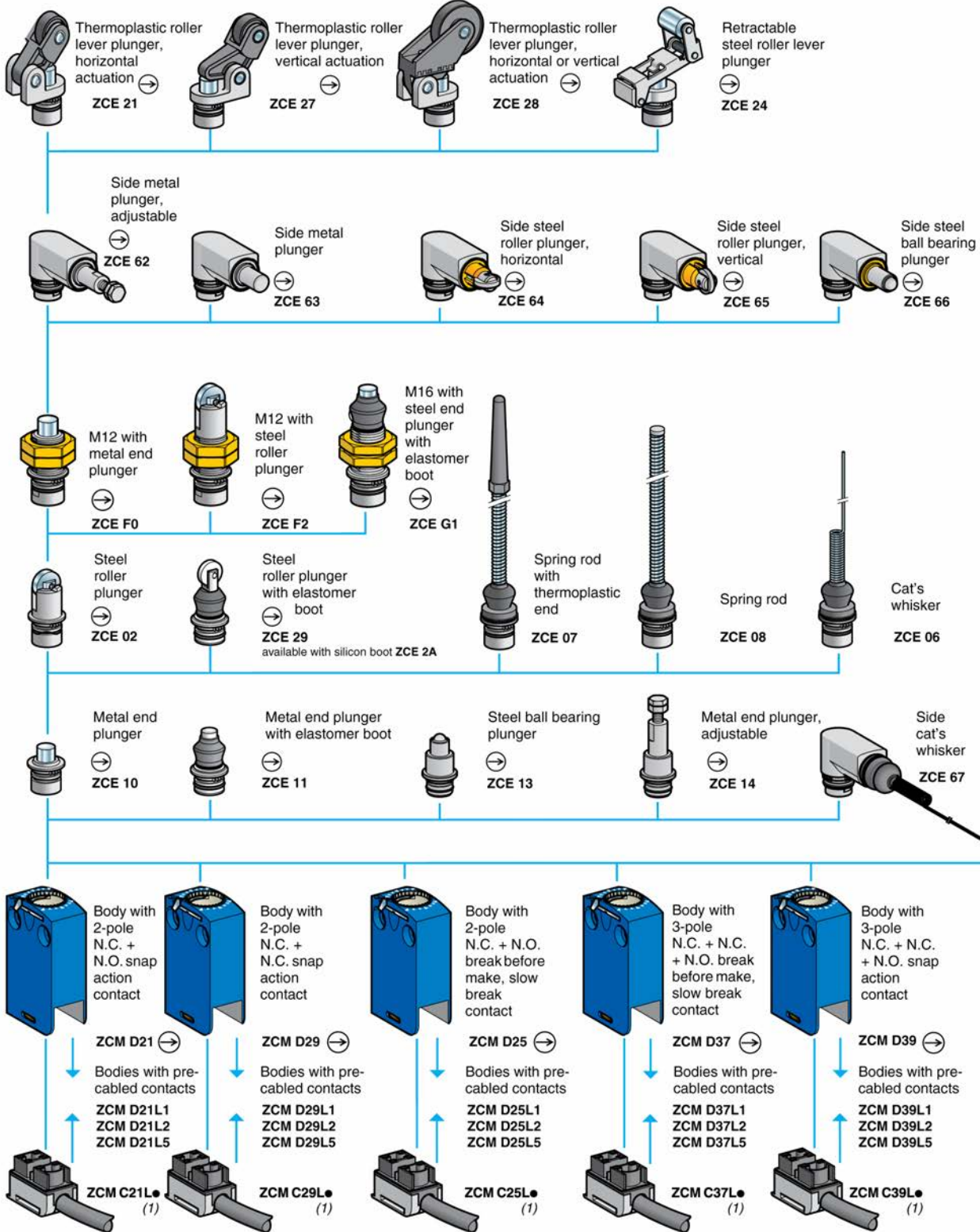

1. Pre-cabled connection components: replace the bullet (•) in the catalog number with the required cable length in meters, either 1, 2, 3, 5, 7 or 10. Example: ZCMC21L• becomes ZCMC21L7 for a 7 m (23.0 ft) cable. Note: only cable lengths of 1, 2 and 5 m (3.3, 6.6, and 16.4 ft) are available for pre-cabled connection components ZCMC37L• and ZCMC39L•.

Dimensions: mm (in.)

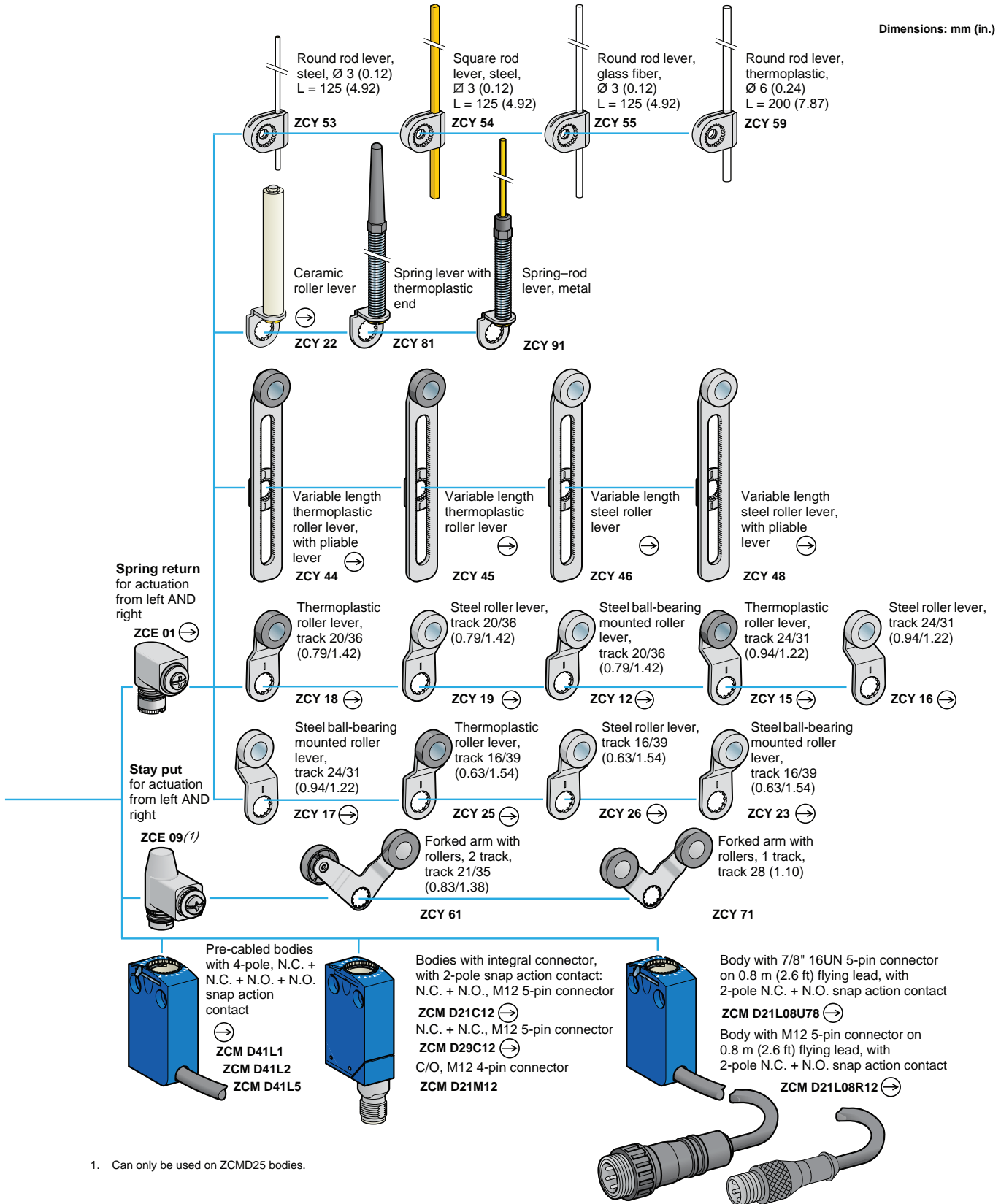

1. Can only be used on ZCMD25 bodies.

Overview — Metal and Plastic

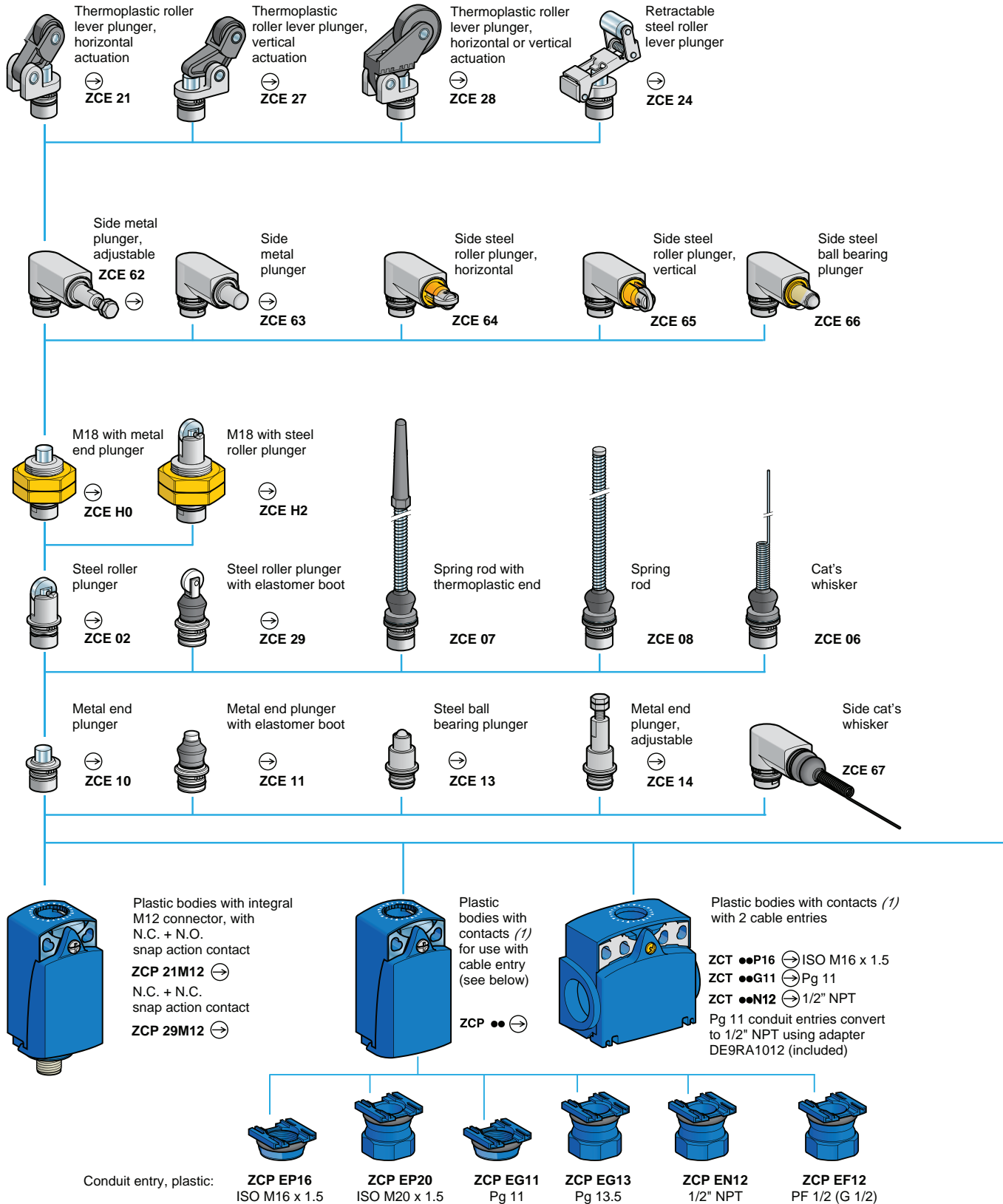

1. For further details, see catalog 9006CT1007.

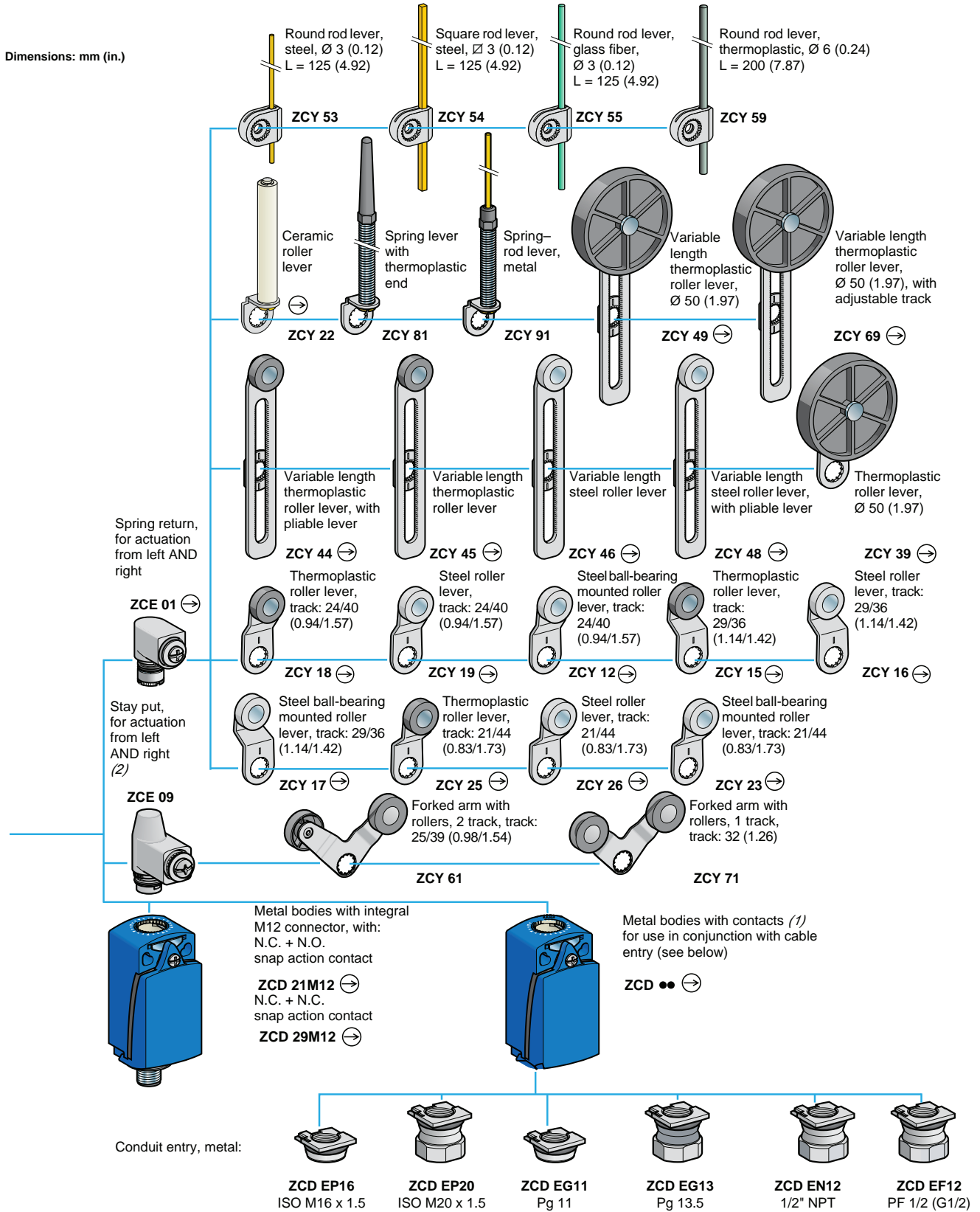

1. For further details, see catalog 9006CT1007.

Miniature, Precabled Limit Switches, Metal

Table 21.16: XCMD Modular and XCMN Non-Modular

OsiSense XCMD, XCMN	Steel Roller Plunger	Plastic Roller Lever	Variable Length Plastic Roller Lever	M12 Head Steel Roller Plunger	Cat Whisker	End Plunger (non-modular)
<p>2-pole contact N.C. + N.O. snap action</p>						
Actuation speed (m/s)	0.5	1.5	1.5	0.1	1	0.5
Switches conforming to IEC 60947-5-1 section 3	yes	yes	yes	yes	no	yes
Degree of protection conforming to IEC 60529	IP66 and IP67	IP66 and IP67	IP66 and IP67	IP66 and IP67	IP66 and IP67	IP65
Rated operational characteristics	Vac 15; B 300 (Ue = 240 V, Ie = 1.5 A) / Vdc 13; R 300 (Ue = 250 V, Ie = 0.1 A)					
Cable entry	pre-cabled, adjustable direction, length = 1 m (other lengths available on request)					pre-cabled length = 1 m
Mounting holes—in. (mm)	0.79 (20)	0.79 (20)	0.79 (20)	0.79 (20)	0.79 (20)	0.79 (20)
Body dimensions—in. (mm), W x D x H	1.18 x 0.63 x 2.32 (30 x 16 x 59)	1.18 x 0.63 x 2.32 (30 x 16 x 59)	1.18 x 0.63 x 2.32 (30 x 16 x 59)	1.18 x 0.63 x 2.32 (30 x 16 x 59)	1.18 x 0.63 x 2.32 (30 x 16 x 59)	1.18 x 0.63 x 2.32 (30 x 16 x 59)
Ordering information	Cat. No.	Cat. No.	Cat. No.	Cat. No.	Cat. No.	Cat. No.
2-pole, N.C. + N.O. snap action	XCMD2102L1	XCMD2115L1	XCMD2145L1	XCMD21F2L1	XCMD2106L1	XCMN2110L1
2-pole, N.C. + N.O. break before make, slow break	XCMD2502L1	XCMD2515L1	XCMD2545L1	XCMD25F2L1	XCMD2506L1	—

Exploded view [page 21-10](#)

Compact, Modular Limit Switches, Metal or Plastic

Table 21.17: XCKD and XCKP Compact, 30 mm Wide, Conforming to Standard EN 50047

OsiSense XCKP	Metal End Plunger	Plastic Roller Lever Horizontal Actuation	M18 Head Metal End Plunger	Plastic Roller Lever	Variable Length Plastic Roller Lever	Rubber Roller Lever Ø 50 mm	Cat Whisker
<p>2-pole contact N.C. + N.O. snap action 2-pole contact N.C. + N.O. slow break</p>							
Actuation speed (m/s)	0.5	1	0.5	1.5	1.5	1.5	1
Switches conforming to IEC 60947-5-1 section 3	yes	yes	yes	yes	yes	yes	no
Degree of protection conforming to IEC 50 529	IP66 and IP67	IP66 and IP67	IP66 and IP67	IP66 and IP67	IP66 and IP67	IP66 and IP67	IP66 and IP67
Rated operational characteristics	Vac 15; A 300 (Ue = 240 V, Ie = 3 A) / Vdc 13; Q 300 (Ue = 250 V, Ie = 0.27 A)						
Cable entry	1 tapped entry for 1/2" NPT						
Mounting holes (mm)	20	20	M18 x 1	20	20	20	20
Body dimensions (mm) W x D x H	30 x 30 x 73	30 x 30 x 73	30 x 30 x 73	30 x 30 x 73	30 x 30 x 73	30 x 30 x 73	30 x 30 x 73
Ordering information	Cat. No.	Cat. No.	Cat. No.	Cat. No.	Cat. No.	Cat. No.	Cat. No.
XCKD Metal, 30 mm Wide							
2-pole, N.C. + N.O. snap action	XCKD2110N12	XCKD2121N12	XCKD21H0N12	XCKD2118N12	XCKD2145N12	XCKD2139N12	XCKD2106N12
2-pole, N.C. + N.O. break before make, slow break	XCKD2510N12	XCKD2521N12	XCKD25H0N12	XCKD2518N12	XCKD2545N12	XCKD2539N12	XCKD2506N12
XCKP Plastic, 30 mm Wide, Double Insulated							
2-pole, N.C. + N.O. snap action	XCKP2110N12	XCKP2121N12	XCKP21H0N12	XCKP2118N12	XCKP2145N12	XCKP2139N12	XCKP2106N12
2-pole, N.C. + N.O. break before make, slow break	XCKP2510N12	XCKP2521N12	XCKP25H0N12	XCKP2518N12	XCKP2545N12	XCKP2539N12	XCKP2506N12

Exploded view [page 21-12](#)

Compact Limit Switches with 2 Cable Entries and Modular Head

Table 21.18: XCKT Compact, Plastic, 2 Cable Entries, Standard, 40 mm

OsiSense XCKT	Metal End Plunger	Metal Roller Plunger	Plastic Roller Lever
<p>2-pole contact N.C. + N.O. snap action</p>			
Actuation speed (m/s)	0.5	0.5	1.5
Switches conforming to IEC 60947-5-1 section 3	yes	yes	yes
Degree of protection conforming to IEC 60529	IP66 and IP67	IP66 and IP67	IP66 and IP67
Rated operational characteristics	Vac 15; A 300 (Ue = 240 V, Ie = 3 A) / Vdc 13; Q 300 (Ue = 250 V, Ie = 0.27 A)		
Cable entry	Two Pg 11 cable entries. One 1/2" NPT adapter, DE9RA1012, is included.		
Mounting holes—in. (mm)	0.79 or 1.57 (20 or 40)	0.79 or 1.57 (20 or 40)	0.79 or 1.57 (20 or 40)
Body dimensions—in. (mm), W x D x H	2.36 x 1.18 x 2.4 (60 x 30 x 61)	2.36 x 1.18 x 2.4 (60 x 30 x 61)	2.36 x 1.18 x 2.4 (60 x 30 x 61)
Ordering information	Cat. No.	Cat. No.	Cat. No.
Complete switch	2-pole, N.C. + N.O. snap action XCKT2110N12	XCKT2102N12	XCKT2118N12

Modular, Compact Limit Switches with Manual Reset

Table 21.19: XCDR and XCPR Compact, Metal or Plastic, with Manual Reset, 30 mm

OsiSense XCDR and XCPR	Metal End Plunger	Plastic Roller Lever Horizontal Actuation	Plastic Roller Lever Vertical Actuation
Actuation speed (m/s)	0.5	1	1
Switches conforming to IEC 60947-5-1 section 3	yes	yes	yes
Degree of protection conforming to IEC 60529	IP66 and IP67	IP66 and IP67	IP66 and IP67
Rated operational characteristics	Vac 15; A 300 (Ue = 240 V, Ie = 3 A) / Vdc 13; Q 300 (Ue = 250 V, Ie = 0.27 A)		
Cable entry	1 tapped entry for 1/2" NPT		
Mounting holes—in. (mm)	0.79 (20)	0.79 (20)	0.79 (20)
Body dimensions—in. (mm), W x D x H	1.18 x 1.18 x 3.74 (30 x 30 x 95)	1.18 x 1.18 x 3.74 (30 x 30 x 95)	1.18 x 1.18 x 3.74 (30 x 30 x 95)
Ordering information	Cat. No.	Cat. No.	Cat. No.
XCDR Metal			
Complete switch	2-pole, N.C. + N.O. snap action XCDR2110N12	XCDR2121N12	XCDR2127N12
	2-pole, N.C. + N.O. break before make, slow break XCDR2510N12	XCDR2521N12	XCDR2527N12
XCPR Plastic, Double Insulated			
Complete switch	2-pole, N.C. + N.O. snap action XCPR2110N12	XCPR2121N12	XCPR2127N12
	2-pole, N.C. + N.O. break before make, slow break XCPR2510N12	XCPR2521N12	XCPR2527N12

Common Head and Levers for XCMD, XCKD, XCKP, XCKT

Table 21.20: Metal Plunger and Multi-Directional Heads

Metal End Plunger	Metal End Plunger with Elastomer Protective Boot	Steel Roller Plunger	Retractable Steel Roller Lever	Plastic Roller Lever, Horizontal Actuation	Plastic Roller Lever, Vertical Actuation
Cat. No. ZCE10	Cat. No. ZCE11	Cat. No. ZCE02	Cat. No. ZCE24	Cat. No. ZCE21	Cat. No. ZCE27

M12 Head Metal Plunger ^[1]	M18 Head Metal Plunger ^[2]	M12 Head Steel Roller Plunger ^[2]	M18 Head Steel Roller Plunger ^[2]	Spring Lever	Spring Lever with Plastic End	Cat Whisker
Bushing Mounted	Bushing Mounted	Bushing Mounted	Bushing Mounted			
Cat. No. ZCEF0	Cat. No. ZCEH0	Cat. No. ZCEF2	Cat. No. ZCEH2	Cat. No. ZCE08	Cat. No. ZCE07	Cat. No. ZCE06

Table 21.21: Metal Rotary Heads and Levers

Rotary Head without Lever, Spring Return, for Actuation from RH or LH Side	Rotary Head without Lever, Stay Put, for Actuation from RH or LH Side ^[3]	Plastic Roller Lever, Track: 24/31 mm (ZCMD) 29/36 mm (ZCD/P/T) ^[1]	Steel Roller Lever, Track: 24/31 mm (ZCMD) 29/36 mm (ZCD/P/T) ^[1]	Plastic Roller Lever, Track: 16/39 mm (ZCMD) 21/44 mm (ZCD/P/T) ^[1]	Steel Roller Lever, Track: 16/39 mm (ZCMD) 21/44 mm (ZCD/P/T) ^[1]	Plastic, Roller Lever, Track: 20/36 mm (ZCMD) 24/40 mm (ZCD/P/T) ^[2]
Cat. No. ZCE01	Cat. No. ZCE09	Cat. No. ZCY15	Cat. No. ZCY16	Cat. No. ZCY25	Cat. No. ZCY26	Cat. No. ZCY18

Steel Roller Lever, for Track: 20/36 mm (ZCMD) 24/40 mm (ZCD/P/T) ^[2]	Ceramic Roller Lever	Variable Length, Rigid Plastic Roller Lever	Variable Length, Bendable Plastic Roller Lever	Variable Length, Rigid Steel Roller Lever	Variable Length, Bendable Steel Roller Lever	Metal Spring Lever
Cat. No. ZCY19	Cat. No. ZCY22	Cat. No. ZCY45	Cat. No. ZCY44	Cat. No. ZCY46	Cat. No. ZCY48	Cat. No. ZCY91

Plastic Roller Lever Ø 50 mm	Adjustable Plastic Roller Lever Ø 50 mm	Square Steel Rod Lever, U 3 mm, length = 125 mm	Round, Glass Fiber Rod Lever, Ø 3 mm length = 125 mm	Round Plastic Rod Lever, Ø 6 mm, length = 200 mm	Forked Lever Arm with 2 Tracks: 25/39 mm	Forked Lever Arm with 1 Track: 32 mm
Cat. No. ZCY39	Cat. No. ZCY49	Cat. No. ZCY54	Cat. No. ZCY55	Cat. No. ZCY59	Cat. No. ZCY61 Recommended for Use with ZCE09 Head	Cat. No. ZCY71 Recommended for Use with ZCE09 Head

[1] Recommended for use with body: ZCMD...
 [2] Recommended for use with body ZCD... / ZCP... / ZCT...
 [3] Can only be used on ZCMD25 bodies.

Body/Contact Assemblies

NOTE: Metal components must be used with metal bodies. Plastic components must be used with plastic bodies.

Table 21.22: Miniature, Metal Body/Contact Assemblies

Type of contact	2-pole N.C. + N.O. Snap action	2-pole N.C. + N.C. Snap action	3-pole N.C. + N.C. + N.O. Snap action	4-pole N.C. + N.C. + N.O. + N.O. Snap action	2-pole N.C. + N.O. Slow break	3-pole N.C. + N.C. + N.O. Slow break	2-pole N.C. + N.O. Snap action 5-pin connector	1 SPDT contact Snap action 4-pin connector
Metal body	Cat. No. ZCMD21	Cat. No. ZCMD29	Cat. No. ZCMD39	Cat. No. ZCMD41	Cat. No. ZCMD25	Cat. No. ZCMD37	Cat. No. ZCMD21C12	Cat. No. ZCMD21M12

Table 21.23: Connection of Miniature Body/Contact Assemblies

Length (m)	Cat. No.	Cat. No.	Cat. No.	Cat. No.	Cat. No.	
Specific pre-cabled connection components						
1	ZCMC21L1	ZCMC29L1	ZCMC39L1	ZCMC25L1	ZCMC37L1	 1 - 2 = N.C. 3 - 4 = N.O. 5 = Ground
2	ZCMC21L2	ZCMC29L2	ZCMC39L2	ZCMC25L2	ZCMC37L2	
5	ZCMC21L5	ZCMC29L5	ZCMC39L5	ZCMC25L5	ZCMC37L5	

Exploded view page 21-10

Table 21.24: Compact, Metal or Plastic Body/Contact Assemblies

Type of contact	2-pole N.C. + N.O. Snap action	2-pole N.C. + N.O. Snap action	3-pole N.C. + N.C. + N.O. Snap action	2-pole N.C. + N.O. Slow break	2-pole N.C. + N.O. Snap action	2-pole N.C. + N.O. Snap action	2-pole N.C. + N.O. Snap action	2-pole N.C. + N.O. Snap action	2-pole N.C. + N.O. Slow break
Metal	Cat. No. ZCD21	Cat. No. ZCD29	Cat. No. ZCD39	Cat. No. ZCD25	Cat. No. —	Cat. No. ZCD21M12	Cat. No. —	Cat. No. —	Cat. No. —
Plastic	Cat. No. ZCP21	Cat. No. ZCP29	Cat. No. ZCP39	Cat. No. ZCP25	Cat. No. ZCP21D44	Cat. No. —	Cat. No. ZCP21M12	Cat. No. ZCT21P16	Cat. No. ZCT25P16

Table 21.25: Connection of Compact Body/Contact Assemblies

	ISO M16	ISO M20	Pg 11	Pg 13.5	1/2" NPT	PF 1/2 NPSF	Deutsch Connector
	Cat. No.	Cat. No.	Cat. No.	Cat. No.	Cat. No.	Cat. No.	Cat. No.
Interchangeable cable entry							
Metal	ZCDEP16	ZCDEP20	ZCDEG11	ZCDEG13	ZCDEN12	ZCDEF12	—
Plastic	ZCPEP16	ZCPEP20	ZCPEG11	ZCPEG13	ZCPEN12	ZCPEF12	ZCPED44

NOTE: Plastic conduit entries shown. Order plastic conduit entries for plastic bodies (XCKP/ZCP). Order metal conduit entries (chrome color) for metal bodies (XCKD/ZCD). Metal conduit entries do not fit on plastic bodies.

Exploded view page 21-12

XCKN / XCNR Compact Plastic, Non-Modular Switches

Table 21.26: XCKN Compact Plastic, Non-Modular, 30 mm Wide



















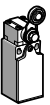

OsiSense Limit Switches						
	2 pole snap action				Thermoplastic roller-lever plunger	
	2 pole break before make, slow break	Metal end plunger	Plastic roller plunger for lateral cam approach	Plastic roller plunger for cross cam approach	Horizontal actuation in 1 direction	Vertical actuation in 1 direction
Switch actuation		On end	By 30° cam			
Type of actuation						
Maximum actuation speed		0.5 m/s (1.64 ft/s)	0.3 m/s (0.99 ft/s)		0.1 m/s (3.28 ft/s)	
Minimum force of torque		For tripping	15 N (3.37 lb)		12 N (2.70 lb)	
		For positive opening	30 N (6.75 lb)		20 N (4.50 lb)	
Weight, kg (lb)		0.065 (0.143)	0.065 (0.143)		0.065 (0.143)	0.070 (0.154)
Ordering Information (sold in packs of 20)		Cat. No.	Cat. No.	Cat. No.	Cat. No.	Cat. No.
2 pole N.C. + N.O. snap action		XCKN2110P20	XCKN2102P20	XCKN2103P20	XCKN2121P20	XCKN2127P20
2 pole N.C. + N.O., break before make, slow break		XCKN2510P20	XCKN2502P20	XCKN2503P20	XCKN2521P20	XCKN2527P20
2 pole N.C. + N.C. snap action		XCKN2910P20	XCKN2902P20	XCKN2903P20	XCKN2921P20	XCKN2927P20
	2 pole snap action					
	2 pole break before make, slow break	Rotary, thermoplastic roller-lever	Rotary, variable length thermoplastic roller-lever	Rotary, variable length, thermoplastic roller-lever, Ø 50 mm	Multi-directional, spring rod	Multi-directional, cat's whisker
Switch actuation		By 30° cam			By any moving part	
Type of actuation						
Maximum actuation speed		1.5 m/s (4.92 ft/s)			1 m/s (3.28 ft/s), any direction	
Minimum force of torque		For tripping			0.1 N·m (0.89 lb-in)	
		For positive opening			0.15 N·m (1.33 lb-in)	
Weight, kg (lb)		0.085 (0.187)	0.090 (0.198)	0.110 (0.243)	0.115 (0.254)	0.085 (0.187)
Ordering Information (sold in packs of 20)		Cat. No.	Cat. No.	Cat. No.	Cat. No.	Cat. No.
2 pole N.C. + N.O. snap action		XCKN2118P20	XCKN2145P20	XCKN2139P20	XCKN2149P20	XCKN2108P20
2 pole N.C. + N.O., break before make, slow break		XCKN2518P20	XCKN2545P20	XCKN2539P20	XCKN2549P20	XCKN2508P20
2 pole N.C. + N.C. snap action		XCKN2918P20	XCKN2945P20	XCKN2939P20	XCKN2949P20	XCKN2908P20

Table 21.27: XCNR Compact Plastic, Non-Modular, with Manual Reset, 30 mm Wide











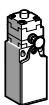

Terminal Diagrams						
	2 pole N.C. + N.O.			Thermoplastic roller-lever plunger		
	2 pole N.C. + N.C.	Metal end plunger	Plastic roller plunger	Horizontal actuation in 1 direction	Vertical actuation in 1 direction	Rotary head, thermoplastic roller-lever plunger
Switch actuation		On end	By 30° cam			
Type of actuation						
Maximum actuation speed		0.5 m/s (1.64 ft/s)	0.3 m/s (0.99 ft/s)	0.1 m/s (3.28 ft/s)		1.5 m/s (4.92 ft/s)
Minimum force of torque		For tripping	15 N (3.37 lb)		12 N (2.70 lb)	
		For positive opening	30 N (6.74 lb)		20 N (4.50 lb)	
Weight, kg (lb)		0.080 (0.18)	0.080 (0.18)	0.085 (0.19)		0.090 (0.20)
Ordering Information (sold in packs of 20)		Cat. No.	Cat. No.	Cat. No.	Cat. No.	Cat. No.
2 pole N.C. + N.O. snap action		XCNR2110P20	XCNR2102P20	XCNR2121P20	XCNR2127P20	XCNR2118P20
2 pole N.C. + N.O. break before make, slow break		XCNR2510P20	XCNR2502P20	XCNR2521P20	XCNR2527P20	XCNR2518P20
2 pole N.C. + N.C. snap action		XCNR2910P20	XCNR2902P20	XCNR2921P20	XCNR2927P20	XCNR2918P20

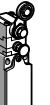
Table 21.28: Cable Entries and Contact Configurations

Cable entry	M20	Order with suffix P20 for 1 entry tapped to M20 x 1.5 mm for ISO cable entry. Clamping capacity 7 to 13 mm (0.28 to 0.51 in.)
	Pg 11	Replace P20 suffix with G11 suffix, 18.6 x 1.41
	1/2" NPT	Replace P20 suffix with G11 suffix. Order 1/2" NPT adapter DE91012
	Other cable entries	For other cable entries, including complete switches with ISO M16 x 1.5 or PF 1/2 (G 1/2) cable entry, please consult your local sales office.
Other contact configurations		For other 2- and 3-pole configurations, please consult your local sales office.
Function diagrams		See catalog 9006CT1007.

New!

XCKS Standard Body, Plastic, Double Insulated

Table 21.29: Environmental Specifications

Conforming to standards	Products	IEC 60947-5-1, EN 60947-5-1, UL 508, CSA C22-2 n° 14
	Machine assemblies	IEC 60204-1, EN 60204-1
Approvals		UL, CSA, CCC
Ambient air temperature	For operation	-25 to +70 °C (-13 to +158 °F)
	For storage	-40 to +70 °C (-40 to +158 °F)
Vibration resistance	Conforming to IEC 60068-2-6	25 gn (10–500 Hz)
Shock resistance	Conforming to IEC 60068-2-27	50 gn (11 ms)
Electric shock protection		Class II conforming to IEC 61140 and NF C 20-030
Degree of protection		IP65 conforming to IEC 60529; IK03 conforming to EN 50102
Repeat accuracy		0.05 mm on the tripping points, with 1 million operating cycles for head with end plunger
Cable entry	Depending on model	Tapped entry for PG 13 conduit thread. To convert to 1/2" NPT, use adapter DE9RA1212 . For ISO M20 x 1.5, add H29 to the end of the catalog number. Example: XCKS101 becomes XCKS101H29 .
Materials		Plastic (body and head)

Table 21.30: Selection, Plunger and Rotary Heads











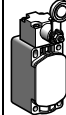
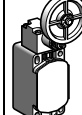
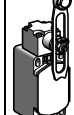

	Form B [1]	Form C [1]	Form A [1]				Form D [1]
 2-pole N.C. + N.O. snap action							
 2-pole N.C. + N.O. break before make, slow break							
 2-pole N.C. + N.C.							
	Metal end plunger	Steel roller plunger	Thermoplastic roller lever [2]	Elastomer roller lever, Ø 50 mm (1.97 in.) [2]	Variable length thermoplastic roller lever [2]	Variable length elastomer roller lever, Ø 50 mm (1.97 in.) [2]	Round thermoplastic rod lever, Ø 6 mm (0.24 in.) [3] [4]
Ordering Information [5]	Cat. No.	Cat. No.	Cat. No.	Cat. No.	Cat. No.	Cat. No.	Cat. No.
2-pole N.C. + N.O. snap action (XE2SP2151)	XCKS101	XCKS102	XCKS131	XCKS139	XCKS141	XCKS149	XCKS159
2-pole N.C. + N.O. break before make, slow break (XE2NP2151)	XCKS501	XCKS502	XCKS531	XCKS539	XCKS541	XCKS549	XCKS559
2-pole N.C. + N.C. snap action (XE2SP2141)	ZCKS9 + ZCKD01	ZCKS9 + ZCKD02	ZCKS9 + ZCKD31	ZCKS9 + ZCKD39	ZCKS9 + ZCKD41	ZCKS9 + ZCKD49	ZCKS9 + ZCKD59
2-pole N.C. + N.C. simultaneous, slow break (XE2NP2141)	ZCKS7 + ZCKD01	ZCKS7 + ZCKD02	ZCKS7 + ZCKD31	ZCKS7 + ZCKD39	ZCKS7 + ZCKD41	ZCKS7 + ZCKD49	ZCKS7 + ZCKD59
Weight, kg (lb)	0.095 (0.209)	0.105 (0.231)	0.145 (0.320)	0.150 (0.331)	0.155 (0.342)	0.155 (0.342)	0.150 (0.331)
Contact operation	⊖ N.C. contact with positive opening operation, when properly mounted and using a conforming operator.			—			

Table 21.31: Specifications

Switch actuation	On end	By 30° cam			By any moving part
Type of actuation					
Maximum actuation speed	0.5 m/s (1.64 ft/s)	1.5 m/s (4.92 ft/s)			1 m/s (3.28 ft/s)
Minimum force or torque	For tripping	15 N (3.37 lb)	12 N (2.70 lb)	0.15 N·m (1.33 lb-in)	
	For positive opening	45 N (10.12 lb)	36 N (8.09 lb)	0.3 N·m (2.66 lb-in)	—
Cable entry	1 entry tapped M20 x 1.5 mm for ISO cable entry, clamping capacity 7 to 13 mm (0.28 to 0.51 in.). To convert PG 13 to 1/2" NPT, use adapter DE9RA1212 . For ISO M20 x 1.5, add H29 to the end of the catalog number. Example: XCKS101 becomes XCKS101H29 .				

[1] Form conforming to EN 50041. See page 6/92 of catalog 9006CT1007.
 [2] Adjustable throughout 360° in 5° steps, or in 90° steps by reversing the notched washer.
 [3] Adjustable throughout 360° in 5° steps, or in 45° steps by reversing the lever mounting.
 [4] Value taken with actuation by moving part at 100 mm (3.94 in.) from the mounting.
 [5] Switches with gold contacts or eyelet type connections: please consult your local sales office.

Complete Switches with 1 Cable Entry

New!



Type of head	Plunger (fixing by the body)		Rotary (fixing by the body)				
Form conforming to EN 50041 [1]	B	C	A	A	A	D	
Type of operator	Metal end plunger	Steel roller plunger	Thermoplastic or steel roller lever [2]	Elastomer roller lever, Ø50 mm [2]	Variable length thermoplastic or steel roller lever [2]	Variable length elastomer roller lever, Ø50 mm [2]	Round thermoplastic rod lever, Ø6 mm [3] [4]
Positive operation				—		—	—
References of complete switches with 1 ISO M20 x 1.5 cable entry							
2-pole NC + NO snap action	XCKS101H29	XCKS102H29	XCKS131H29 (thermoplastic) (steel)	XCKS139H29	XCKS141H29 (thermoplastic) (steel)	XCKS149H29	XCKS159H29
2-pole NC + NO break before make, slow break	XCKS501H29	XCKS502H29	XCKS531H29 (thermoplastic) (steel)	XCKS539H29	XCKS541H29 (thermoplastic) (steel)	XCKS549H29	XCKS559H29
Weight, kg (lb)	0.125 (0.28)	0.135 (0.30)	0.160 (0.35)	0.175 (0.39)	0.165 (0.36)	0.180 (0.40)	0.170 (0.37)
Contact operation			(A) = cam displacement (P) = positive opening point		NC contact with positive opening operation		

Catalog numbers of complete switches with 1 Pg 13.5 cable entry

For an entry tapped for a Pg 13.5 cable gland, delete H29 from the end of the reference. (Except XCKS133H29, XCKS143H29, XCKS533H29 and XCKS543H29). Example: XCKS101H29 becomes XCKS101.

Catalog numbers of complete switches with 1/2" NPT cable entry

For an entry tapped for a 1/2" NPT cable gland, replace H29 at the end of the reference by H7. (Except XCKS133H29, XCKS143H29, XCKS501H29, XCKS533H29, XCKS539H29, XCKS543H29, XCKS549H29 and XCKS559H29). Example: XCKS101H29 becomes XCKS101H7.

Specifications

Switch actuation	On end	By 30° cam	By any moving part			
Type of actuation				or		
Maximum actuation speed	0.5 m/s (1.64 ft/s)		1.5 m/s (4.92 ft/s)		1 m/s (3.28 ft/s)	
Mechanical durability (in millions of operating cycles)	25	15	20			
Minimum force or torque	For tripping	15 N (3.37 lbf)	12 N (2.70 lbf)	0.10 N•m (0.86 lb-in)		—
	For positive opening	30 N (6.74 lbf)	20 N (4.50 lbf)	0.15 N•m (1.33 lb-in)	—	0.15 N•m (1.33 lb-in)
Cable entry	1 entry tapped M20 x 1.5 mm for ISO cable gland, clamping capacity 7–13 mm					

[1] Form conforming to EN 50041, see page 31900/9.
 [2] Adjustable throughout 360° in 5° steps, or in 90° steps by reversing the notched washer.
 [3] Adjustable throughout 360° in 5° steps, or in 45° steps by reversing the lever mounting.
 [4] Value taken with actuation by moving part at 100 mm from the fixing.

Variable Composition Switches with 1 Cable Entry



NOTE: ZCKD heads can only be used with ZCKS bodies.

Catalog numbers of variable composition switches (ZCKS bodies and ZCKD heads) with 1 ISO M20 x 1.5 cable entry [5]

Form conforming to EN 50041 [6]	B	C	A	A	A	A	D
Type of operator	Metal end plunger	Steel roller plunger	Thermoplastic roller lever [7]	Elastomer roller lever, Ø50 mm [7]	Variable length thermoplastic roller lever [7]	Variable length elastomer roller lever, Ø50 mm [7]	Round thermoplastic rod lever, Ø6 mm [8] [9]
Positive operation				—		—	—
2-pole NC + NC snap action (XE2SP2141)	ZCKS9H29 + ZCKD01 	ZCKS9H29 + ZCKD02 	ZCKS9H29 + ZCKD31 	ZCKS9H29 + ZCKD39 	ZCKS9H29 + ZCKD41 	ZCKS9H29 + ZCKD49 	ZCKS9H29 + ZCKD59
2-pole NC + NC simultaneous, slow break (XE2NP2141)	ZCKS7H29 + ZCKD01 	ZCKS7H29 + ZCKD02 	ZCKS7H29 + ZCKD31 	ZCKS7H29 + ZCKD39 	ZCKS7H29 + ZCKD41 	ZCKS7H29 + ZCKD49 	ZCKS7H29 + ZCKD59
3-pole NC + NC + NO snap action (XE3SP2141)	ZCKSD39H29 + ZCKD01 	ZCKSD39H29 + ZCKD02 	ZCKSD39H29 + ZCKD31 	ZCKSD39H29 + ZCKD39 	ZCKSD39H29 + ZCKD41 	ZCKSD39H29 + ZCKD49 	ZCKSD39H29 + ZCKD59
3-pole NC + NC + NO break before make, slow break (XE3NP2141)	ZCKSD37H29 + ZCKD01 	ZCKSD37H29 + ZCKD02 	ZCKSD37H29 + ZCKD31 	ZCKSD37H29 + ZCKD39 	ZCKSD37H29 + ZCKD41 	ZCKSD37H29 + ZCKD49 	ZCKSD37H29 + ZCKD59
Weight, kg (lb)	0.095 (0.21)	0.105 (0.23)	0.145 (0.32)	0.150 (0.33)	0.155 (0.34)	0.155 (0.34)	0.150 (0.33)
Contact operation		closed open	(A) = cam displacement (P) = positive opening point				NC contact with positive opening operation

Catalog numbers of variable composition switches (ZCKS bodies and ZCKD heads) with 1 Pg 13.5 cable entry

For ZCKS bodies with 1 Pg 13.5 cable entry, delete H29 from the end of the reference. Example: ZCKS1H29 becomes ZCKS1.

Specifications

Switch actuation	On end	By 30° cam	By any moving part	
Type of actuation				
Maximum actuation speed	0.5 m/s (1.64 ft/s)		1.5 m/s (4.92 ft/s)	
Mechanical durability [10] (in millions of operating cycles)	25	15	20	
Minimum force or torque	For tripping	15 N (3.37 lbf)	12 N (2.70 lbf)	0.15 N•m (1.33 lb-in)
	For positive opening	45 N (10.12 lbf)	36 N (8.09 lbf)	0.3 N•m (2.66 lb-in)
Cable entry	1 entry tapped M20 x 1.5 mm for ISO cable gland, clamping capacity 7–13 mm			

[5] Switches with gold contacts or eyelet type connections: please consult our Customer Care Centre.

[6] Form conforming to EN 50041

[7] Adjustable throughout 360° in 5° steps, or in 90° steps by reversing the notched washer.

[8] Adjustable throughout 360° in 5° steps, or in 45° steps by reversing the lever mounting.

[9] Value taken with actuation by moving part at 100 mm from the fixing.

[10] Limited to 15 million operating cycles for switches with contacts XE3P.

Variable Composition Switches—Bodies and Accessories

Table 21.32: Bodies with 2-Pole Contact

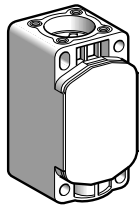

ZCKS*

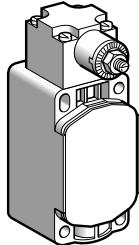

ZCKS404



XE2SP21*1

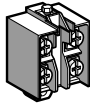

XE2NP21*1

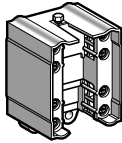

XE3SP21

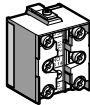

XE3*P21**



DE9RA**12

Style	With contact block	Positive operation	Cable entry	Catalog No.	Weight, kg (lb)
1 step	NC + NO snap action (XE2SP2151)	→	Pg 13.5	ZCKS1	0.080 (0.18)
			ISO M20 x 1.5	ZCKS1H29	0.080 (0.18)
	2 CO simultaneous, snap action (XESP3021)	—	Pg 13.5	ZCKS2	0.080 (0.18)
			ISO M20 x 1.5	ZCKS2H29	0.080 (0.18)
	NC + NO break before make, slow break (XE2NP2151)	→	Pg 13.5	ZCKS5	0.080 (0.18)
			ISO M20 x 1.5	ZCKS5H29	0.080 (0.18)
	NO + NC make before break, slow break (XE2NP2161)	→	Pg 13.5	ZCKS6	0.080 (0.18)
			ISO M20 x 1.5	ZCKS6H29	0.080 (0.18)
	NC + NC simultaneous, slow break (XE2NP2141)	→	Pg 13.5	ZCKS7	0.080 (0.18)
			ISO M20 x 1.5	ZCKS7H29	0.080 (0.18)
NO + NO simultaneous, slow break (XE2NP2131)	—	Pg 13.5	ZCKS8	0.080 (0.18)	
		ISO M20 x 1.5	ZCKS8H29	0.080 (0.18)	
NC + NC snap action (XE2SP2141)	→	Pg 13.5	ZCKS9	0.080 (0.18)	
		ISO M20 x 1.5	ZCKS9H29	0.080 (0.18)	

Table 21.33: Bodies with Double-Pole Contact and Spring Return Rotary Head

Without operating lever					
Style	With contact block	Positive operation	Cable entry	Catalog No.	Weight, kg (lb)
2 step 1 from left and 1 from right	2 CO staggered snap action	—	Pg 13.5	ZCKS404	0.150 (0.33)
			ISO M20 x 1.5	ZCKS404H29	0.150 (0.33)

Table 21.34: Bodies with 3-Pole Contact and 1 Cable Entry

Style	With contact block	Positive operation (†)	Cable entry	Catalog No.	Weight, kg (lb)
—	NC + NO + NO snap action (XE3SP2151)	→	Pg 13.5	ZCKSD31	0.080 (0.18)
			ISO M20 x 1.5	ZCKSD31H29	0.080 (0.18)
	NC + NC + NO snap action (XE3SP2141)	→	Pg 13.5	ZCKSD39	0.080 (0.18)
			ISO M20 x 1.5	ZCKSD39H29	0.080 (0.18)
	NC + NC + NO break before make, slow break (XE3NP2141)	→	Pg 13.5	ZCKSD37	0.080 (0.18)
			ISO M20 x 1.5	ZCKSD37H29	0.080 (0.18)
	NC + NO + NO break before make, slow break (XE3NP2151)	→	Pg 13.5	ZCKSD35	0.080 (0.18)
			ISO M20 x 1.5	ZCKSD35H29	0.080 (0.18)

Table 21.35: Contact Blocks for ZCKS Bodies

Type of contact	For body	Positive operation	Catalog No.	Weight, kg (lb)
2-pole contact				
NC + NO snap action	ZCKS1	→	XE2SP2151	0.020 (0.04)
NC + NO break before make, slow break	ZCKS5	→	XE2NP2151	0.020 (0.04)
2 CO simultaneous snap action	ZCKS2	—	XESP3021	0.045 (0.10)
NO + NC make before break, slow break	ZCKS6	→	XE2NP2161	0.020 (0.04)
NC + NC simultaneous, slow break	ZCKS7	→	XE2NP2141	0.020 (0.04)
NO + NO simultaneous, slow break	ZCKS8	—	XE2NP2131	0.020 (0.04)
NC + NC snap action	ZCKS9	→	XE2SP2141	0.020 (0.04)
3-pole contact				
NC + NO + NO snap action	ZCKSD31	→	XE3SP2151	0.035 (0.08)
NC + NC + NO snap action	ZCKSD39	→	XE3SP2141	0.035 (0.08)
NC + NC + NO break before make, slow break	ZCKSD37	→	XE3NP2141	0.035 (0.08)
NC + NO + NO break before make, slow break	ZCKSD35	→	XE3NP2151	0.035 (0.08)

Table 21.36: Accessories for ZCKS and XCKS

Description	Minimum order quantity	Catalog No.	Weight, kg (lb)
Adapter for 1/2" NPT conduit (male Pg 13.5 / female 1/2" NPT)	10	DE9RA1212	0.035 (0.08)
Adapter for 1/2" NPT conduit (male M20 x 1.5 / female 1/2" NPT)	5	DE9RA2012	0.050 (0.11)
Other versions	Gold flashed contacts. Consult the Customer Care Center (1-888-778-2733).		

→ NC contact with positive opening operation, or head assuring positive opening operation

Table 21.37: Limit Switch Catalog Numbers *New!*

Actuator type	Reference	Weight, kg (lb)
Metal plunger	XCKW101	0.210 (0.46)
Steel roller plunger	XCKW102	0.220 (0.49)
Thermoplastic roller lever	XCKW131	0.240 (0.53)
Steel roller lever	XCKW133	0.245 (0.54)
Variable length thermoplastic roller lever	XCKW141	0.260 (0.57)
Variable length steel roller lever	XCKW143	0.265 (0.58)
Elastomer roller lever, Ø50 mm	XCKW139	0.220 (0.49)
Variable length elastomer roller lever, Ø50 mm	XCKW149	0.270 (0.60)
Round thermoplastic rod lever, Ø6 mm	XCKW159	0.230 (0.51)



XCKW101



XCKW102



XCKW159



XCKW131



XCKW133



XCKW139



XCKW141



XCKW143



XCKW149

Table 21.38: Ready-to-Use Packs, Catalog Numbers

Composition	Reference	Weight, kg (lb)
<ul style="list-style-type: none"> 1 limit switch with steel roller plunger XCKW102. 1 receiver with 2 relay outputs ZBRRD. 	XCKWD02 [1]	0.410 (0.90)
<ul style="list-style-type: none"> 1 limit switch with thermoplastic roller lever XCKW131. 1 receiver with 2 relay outputs ZBRRD. 	XCKWD31 [1]	0.410 (0.90)

NB: The transmitter (limit switch) and receiver are factory-paired.



Table 21.39: Receivers

Number and type of outputs	Power supply	Number of transmitters	Reference	Weight, kg (lb)
4 PNP outputs 200 mA / 24 V	24-Vdc	32	ZBRRC [1]	0.130 (0.29)
2 relay outputs type C/O, 3A	24-240 Vac/Vdc	32	ZBRRD [1]	0.130 (0.29)
2 PNP outputs 200 mA / 24 V	24 Vdc	2	XZBWR2STT24 [2]	0.130 (0.29)



Network Access Points

Table 21.40: Network Access Points ^{New!}

Description	Data Function	Output Type	Receiver Voltage	Catalog Number	Weight, kg
Configurable access points equipped with: <ul style="list-style-type: none"> 7-segment display jog dial 8 LED indicators (power ON, function modes, communication status, signal strength) external antenna connector and protective cap for 60 transmitters max. 	Set/Reset	2 RS485 connectors that provide Modbus RS485 serial link connectivity	24-240 Vac/Vdc	ZBRN2 [3]	0.270 (0.60)
	Set/Reset	1 slot for communication module (to be ordered separately)	24-240 Vac/Vdc	ZBRN1 [3]	0.270 (0.60)



[1] Schneider Electric product, also compatible with **ZB-RTA** wireless push buttons (with a software version \geq V2.0).
 [2] Also compatible with **ZB-RTA** wireless push buttons and the **XZBWE112A24** wireless multi-sensor transmitter (with a software version \geq V1.0).
 [3] Schneider Electric product, also compatible with **ZB-RTA** wireless push buttons (with a software version above or equal to V1.5).

Accessories

Table 21.41: Modbus/TCP network communication module

Description	Communication port	Reference	Weight, kg (lb)
Communication module for access point ZBRN1 Modbus/TCP protocol with embedded web pages, available in 5 languages, for configuration, monitoring and diagnostics	2 RJ45 connectors for daisy chain or daisy chain loop operation	ZBRCETH[4]	0.044 (0.10)



ZBRCETH

Table 21.42: Antennas

Use	Description	Reference	Weight, kg (lb)
Relay Antenna			
Increases the distance between the limit switches and the receivers	24–240 Vac/Vdc 5 m cable, 1 Power On LED, 2 reception/transmission LEDs	ZBRA1[5]	0.200 (0.04)
External antenna			
Connected to access point (ZBRN1 or ZBRN2) to increase the transmission distance	2 m cable 1 RF connector	ZBRA2[4]	0.040 (0.09)



ZBRA1



ZBRA2

[4] Schneider Electric product.
[5] Schneider Electric product, also compatible with **ZB-RTA** wireless push buttons.

Overview — Metal, Variable Composition

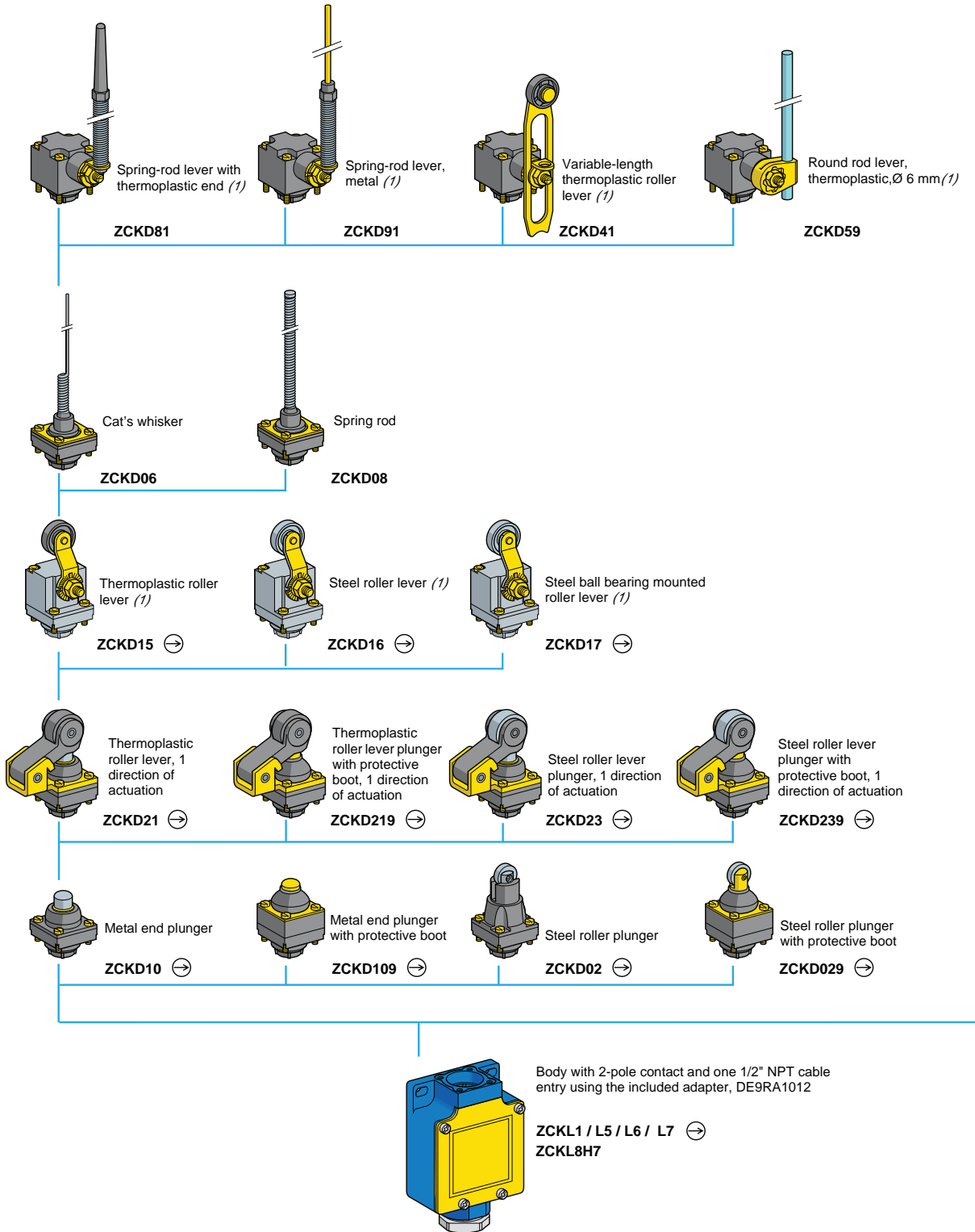

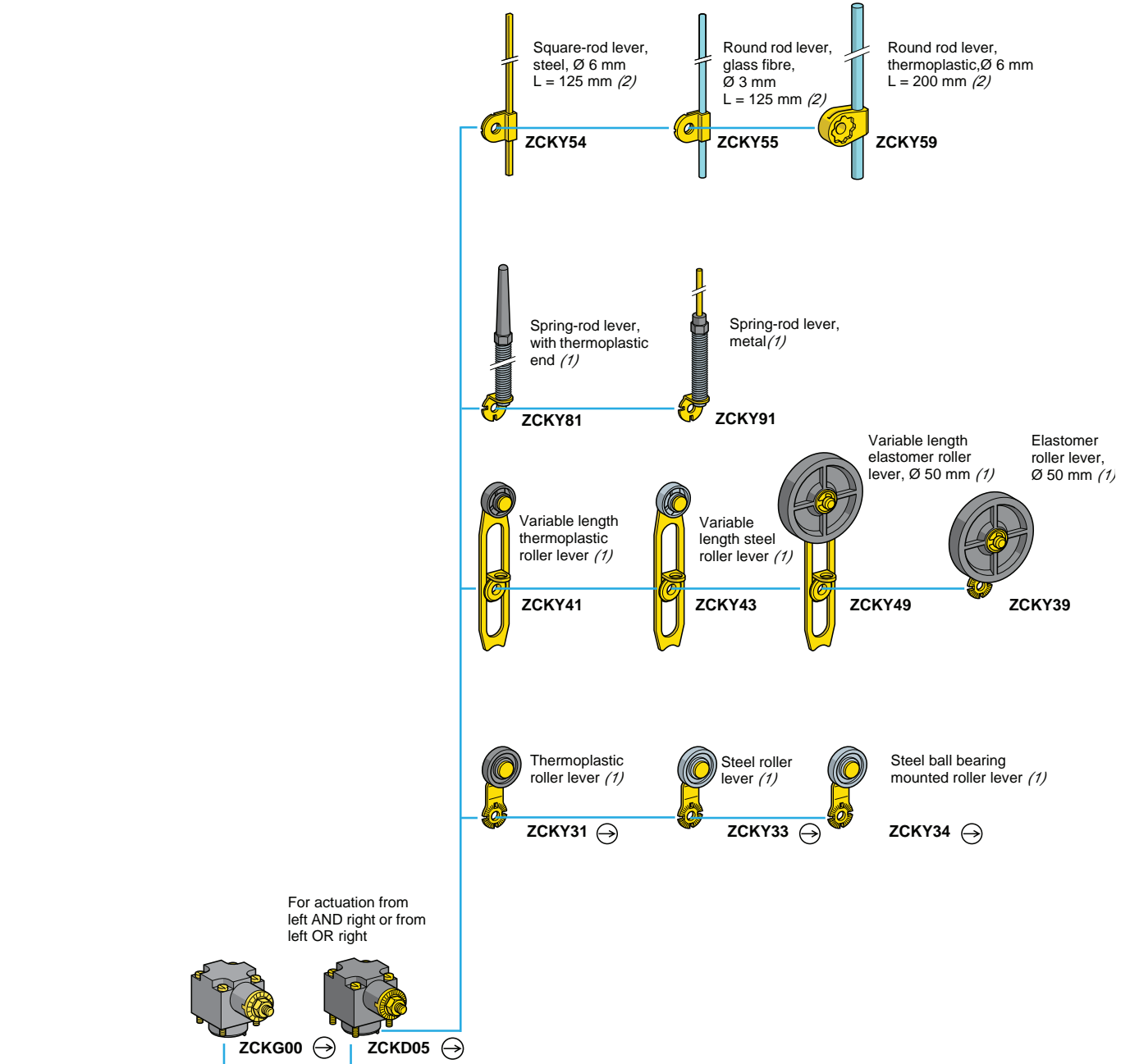

- ⊕ Head assuring positive opening operation when used with a conforming lever.
- (1) Adjustable throughout 360° in 5° steps, or in 90° steps by reversing the notched washer.
- (2) Adjustable throughout 360° in 5° steps, or in 45° steps by reversing the lever mounting.

XCKL Limit Switch

XCKL is a compact, general-duty limit switch for applications such as machine tools and material handling.



XCKL110H7

Table 21.43: Specifications

Rated Power (conforms to IEC 947-5-1, duty categories AC15 and DC13)	
Temperature range	-13 to +158 °F (-25 to +70 °C) The minimum temperatures listed are based on the absence of freezing moisture or water.
Enclosure rating	NEMA Type 1, 2, 3, 4, 12 IP66
Vibration resistance	25 G (10–500 Hz), conforming to IEC 68-2-6
Shock resistance	50 G, conforming to IEC 68-2-27
Repeatability	0.002 in. (0.05 mm)
Cable entry	Standard: Pg 11 with DE9RA1012 adapter for 1/2" NPT conduit entry
Contact Characteristics	
Rated thermal current	10 A
Rated insulation voltage	300 Vac and dc (A300 and Q300)
Contact resistance (max.)	25 mW
Cable (max.)	2 x #16 AWG (1.5 mm ²) per terminal
Short circuit protection (customer supplied)	10 A fuse type SC. Outside U.S. use gl or N.

Complete Switches

Table 21.44: Lever Operated Switches

Description [1]	Functional Diagram	Operating Torque/Force	Contact Configuration	Catalog Number
Programmable head CW and/or CCW—snap action Delrin® roller lever—adjustable in 5° or 45° increments (reversible mounting) →		14.2 oz-in	SPDT (N.O. + N.C.) snap	XCKL10011H7
		14.2 oz-in	SPDT (N.O. + N.C.) slow	XCKL50011H7
Adjustable length roller lever—adjustable in 5° or 45° increments (reversible mounting) →		14.2 oz-in	SPDT (N.O. + N.C.) snap	XCKL10041H7
		14.2 oz-in	SPDT (N.O. + N.C.) slow	XCKL50041H7
CW and CCW, Delrin roller lever →		21.3 oz-in	SPDT (N.O. + N.C.) snap	XCKL115H7
		21.3 oz-in	SPDT (N.O. + N.C.) slow	XCKL515H7
One way lever-Delrin roller →		25.3 oz-in	SPDT (N.O. + N.C.) snap	XCKL121H7
		25.3 oz-in	SPDT (N.O. + N.C.) slow	XCKL521H7



XCKL10011H7



XCKL115H7

Table 21.45: Omnidirectional

Description [1]	Functional Diagram	Operating Torque/Force	Contact Configuration	Catalog Number
Wobble stick-steel rod		1.84 oz-in	SPDT (N.O. + N.C.) snap	XCKL106H7
		1.84 oz-in	SPDT (N.O. + N.C.) slow	XCKL506H7



XCKL110H7



XCKL102H7

Table 21.46: Plunger Operated

Description [1]	Functional Diagram	Operating Torque/Force	Contact Configuration	Catalog Number
Rod plunger →		35.6 oz	SPDT (N.O. + N.C.) snap	XCKL110H7
		35.6 oz	SPDT (N.O. + N.C.) slow	XCKL510H7
Roller plunger →		35.6 oz	SPDT (N.O. + N.C.) snap	XCKL102H7
		35.6 oz	SPDT (N.O. + N.C.) slow	XCKL502H7

Exploded view [page 21-26](#)

Lever arms [page 21-29](#)



File E39281
CCN NKCR



File Class LR44087
3211-03



Acceptable Wire Sizes: 14–24 AWG
Recommended Terminal Clamp Torque: 13 lb-in

[1] Diagrams shown are for XCKL1 . . .

XCKL Components



ZCKL1H7, ZCKL5H7



ZCKG00H7



ZCKD15, 16, 17H7

BUILDING A COMPLETE SWITCH

Complete Switch = Body (with contact assembly) + Head + Lever

Examples:

Body ZCKL1H7 + **Head** ZCKD15 = **XCKL115H7**

Body ZCKL5H7 + **Head** ZCKD02 = **XCKL502H7**

Body ZCKL1H7 + **Head** ZCKG00 + **Lever** ZCKY11 = **XCKL10011H7**

NOTE: Some combinations are not available as complete switches.

Table 21.47: Bodies—Electric

Components	Contacts	Catalog Number
Body: Single pole, double break, 1 N.O. + 1 N.C. Snap action, positive opening, same polarity	Silver	ZCKL1H7
	Gold Flashed	ZCKL18H7
Body: Single pole, double break, 1 N.O. + 1 N.C. Slow make, slow break isolated	Silver	ZCKL5H7

Table 21.48: Rotary Heads

Components	Catalog Number
Programmable head [2] CW and/or CCW	Select lever arm separately ZCKG00
Offset Delrin roller lever [3]	ZCKD15
Offset steel roller lever [3]	ZCKD16
Offset ball-bearing roller lever [3]	ZCKD17

Table 21.49: Plunger Heads

Description	Catalog Number
Rod plunger	ZCKD10
Booted rod plunger	ZCKD109
Roller plunger	ZCKD02
Booted roller plunger	ZCKD029
One-way lever—Delrin roller	ZCKD21
Steel roller	ZCKD23

Table 21.50: Omnidirectional Heads

Description	Catalog Number
Cat whisker—steel rod [4]	ZCKD06
Wobble spring—steel spring [4]	ZCKD08

Table 21.51: Replacement Parts

Description	Catalog Number
Contact block for ZCKL1	XESP2151
Contact block for ZCKL5	XENP2151
Gold flashed contact block for ZCKL18	XESP2158
Pg 11 to 1/2" NPT conduit entry adapter	DE9RA1012

Table 21.52: Levers (for use with ZCKG00 heads only—will not fit ZCKD heads)

Description	Size	Adjustment [5] Increments	Catalog Number
Delrin roller	0.9 in. diameter, 0.2 in. wide, 1.6 in. long	5° or 45°	ZCKY11
Steel roller	0.9 in. diameter, 0.2 in. wide, 1.6 in. long	5° or 45°	ZCKY13
Ball bearing roller	0.9 in. diameter, 0.2 in. wide, 1.6 in. long	5° or 45°	ZCKY14
Adjustable length Delrin roller [6]	0.74 in. diameter, 0.2 in. wide, 4.2 in. long (max.)	5° or 90°	ZCKY41
Steel roller	0.74 in. diameter, 0.2 in. wide, 4.2 in. long (max.)	5° or 90°	ZCKY43
Steel rod, square [6]	1/8 in. side, 5.4 in. long (max.)	5° or 45°	ZCKY51
Fiberglass rod, round [6]	1/8 in. diameter, 5.4 in. long (max.)	5° or 45°	ZCKY52
Steel rod, round [6]	1/8 in. diameter, 5.4 in. long (max.)	5° or 45°	ZCKY53
Plastic rod, round [6]	1/4 in. diameter, 8.4 in. long (max.)	5° or 45°	ZCKY59
Fork, 2 track Delrin roller	0.9 in. diameter, 0.2 in. wide for ZCKE092	5° or 45°	ZCKY71
Coil spring lever [6]	4.41 in. (112 mm)	5° or 45°	ZCKY81
Spring rod lever [6]	7.05 in. (179 mm)	5° or 45°	ZCKY91

Acceptable Wire Sizes: 14–24 AWG
Recommended Terminal Clamp Torque: 13 lb-in

ZCKG00 Programming

The ZCKG00 head is field convertible to CW, CCW, or CW/CCW.

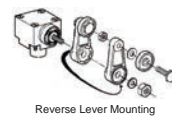

File: 78403
CCN: NKCR



File: LR25490
Class: 3211 03



[2] See page 21-28
[3] Replacement arms are not available separately. Order complete head as a replacement.
[4] Replacement cat whiskers and wobble extensions are not available separately. Order complete head as a replacement.
[5] Reverse mounting (for ZCKG00 head)—The higher increment (45° or 90°) is a positive opening contact feature which ensures no loss of mechanical effort between the actuation point and the moving contact bridge of the N.C. contact even if the lever is loosely mounted on the head shaft.
[6] Flexible operators do not guarantee direct (positive) opening operation.

Overview — Standard Industrial, Metal

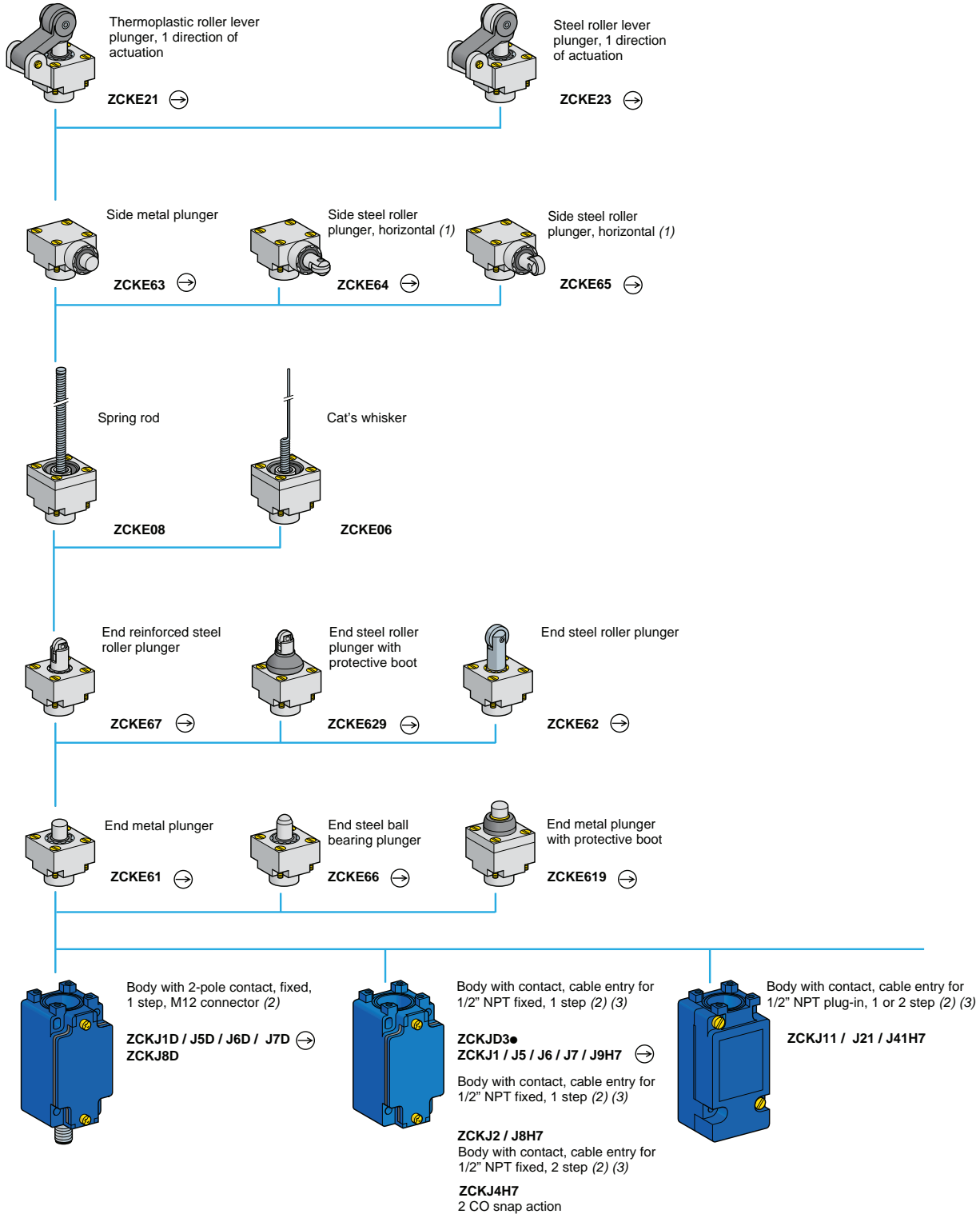

(1) Cannot be used with bodies ZCKJ4H7 and ZCKJ41H7.
 (2) For further information, see page 21-27.
 (3) For a cable entry tapped ISO M20 x 1.5, change H7 to H29. Example: ZCKJ1H7 becomes ZCKJ1H29.
 For a cable entry tapped Pg 13.5, delete H7 from the catalog number. Example: JCKJ1H7 becomes ZCKJ1.

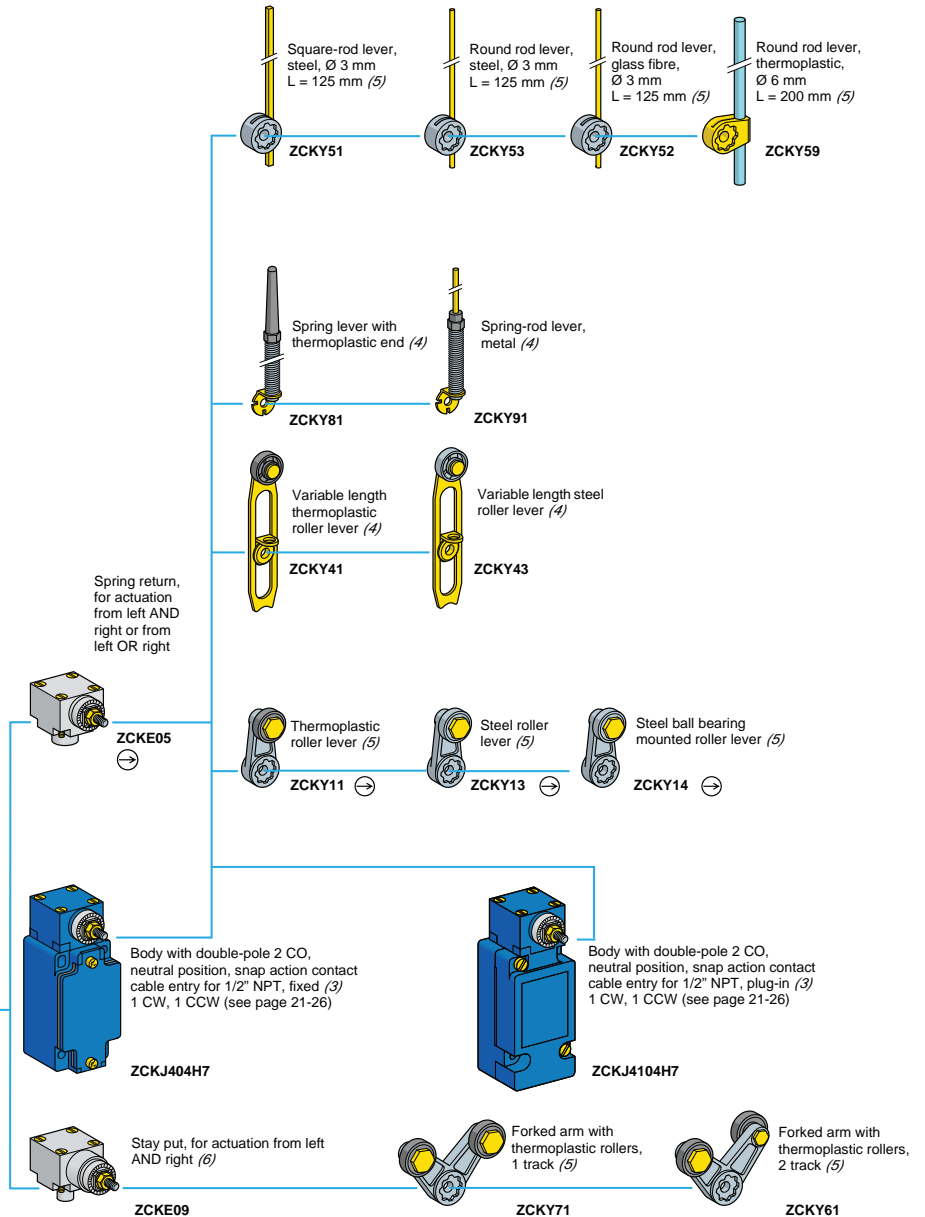

⊖ Head assuring positive opening operation when used with a conforming lever.
 (4) Adjustable throughout 360° in 5° steps, or in 90° steps by reversing the notched washer.
 (5) Adjustable throughout 360° in 5° steps, or in 45° steps by reversing the lever mounting.
 (6) Suitable for bodies with contacts ZCKJ1 / J2 / J31 / J39H7.

XCKJ Switches

XCKJ fixed body type precision switches with an SPDT configuration have direct opening contacts to meet most international standards.

Table 21.53: Specifications

Rated Power (conforms to IEC 947-5-1, duty categories AC15 and DC13)	
Temperature range	-13 to +158 °F (-25 to +70 °C); optional -40 to +248 °F (-40 to +120 °C). The minimum temperatures listed are based on the absence of freezing moisture or water.
Enclosure rating	NEMA 1, 2, 3, 4, 12; IEC Type IP66
Vibration resistance	25 G (10–500 Hz), conforming to IEC 68-2-6
Shock resistance	50 G, conforming to IEC 68-2-27
Repeatability (max.)	0.0004 in. (0.01 mm)
Cable entry	1/2" NPT standard
Contact Characteristics	
Rated thermal current	10 A, conforming to UL 508, CSA C22-2 No.14, IEC 337-1, NFC 63-140, VDE 0660-200
Rated insulation voltage	Non-plug-in: 300 Vac (A300) and DC (Q300) Plug-in: 600 Vac (A600) and DC (Q600)
Contact resistance (max)	Non-plug-in: 25 m W Plug-in: 45 m W
Cable (max.)	2 x 16 AWG (1.5 mm ²) per terminal—1 x #16 AWG for 2 SPDT (2 N.O., 2 N.C.)
Short circuit protection	10 A fuse type SC; Form I Class J or equivalent. Outside US use type gl or N.

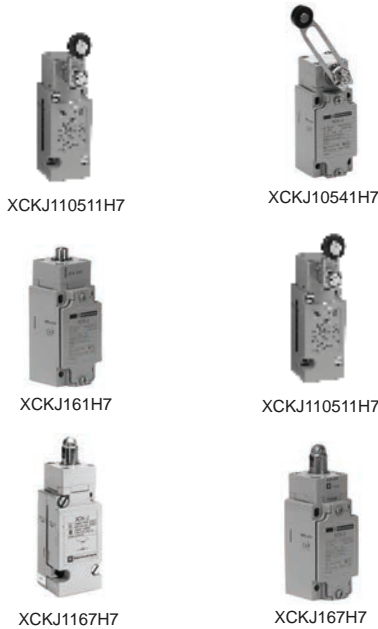

Table 21.54: Complete Switches, XCKJ

Description and Functional Diagram	Operating Torque	Contact Type	Direct Opening	Catalog Number	
Non-plug-in Housings					
Delrin roller lever adjustable in 5° or 45° increments (reversible mountings)					
	33.3 oz-in	SPDT (N.O. + N.C.)	Y [1]	XCKJ10511H7	
	33.3 oz-in	2 SPDT (2 N.O. + 2 N.C.)	N	XCKJ20511H7	
Adjustable length—Delrin roller lever adjustable in 5° or 90° increments					
	33.3 oz-in	SPDT (N.O. + N.C.)	N	XCKJ10541H7	
	33.3 oz-in	2 SPDT (2 N.O. + 2 N.C.)	N	XCKJ20541H7	
Adjustable length—1/8 in. diameter steel rod adjustable in 5° or 45° increments					
	33.3 oz-in	SPDT (N.O. + N.C.)	N	XCKJ10553H7	
	33.3 oz-in	SPDT (N.O. + N.C.)	N	XCKJ10559H7	
Adjustable length—1/4 in. plastic rod adjustable in 5° or 45° increments					
	33.3 oz-in	SPDT (N.O. + N.C.)	N	XCKJ10559H7	
	33.3 oz-in	SPDT (N.O. + N.C.)	N	XCKJ10559H7	
Neutral Position One SPDT contact switch per direction. Past 20° CW, contact 1 (11-12 / 13-14) switches. Past 20° CCW, contact 2 (21-22 / 23-24) switches. Levers not included.					
	26.6 oz-in	2 SPDT (2 N.O. + 2 N.C.)	N	ZCKJ404H7	
Plunger Operated					
	Rod plunger 48 oz	SPDT	(N.O. + N.C.)	Y [1]	XCKJ161H7
	Steel roller plunger 48 oz	SPDT	(N.O. + N.C.)	Y [1]	XCKJ167H7
Plug-in Housings					
Lever Operated					
	33.3 oz-in	SPDT	(N.O. + N.C.)	N	XCKJ110511H7
Adjustable length Delrin roller lever adjustable in 5° or 90° increments					
	33.3 oz-in	SPDT	(N.O. + N.C.)	N	XCKJ110541H7
Neutral Position One SPDT contact switch per direction. Past 20° CW, contact 1 (11-12 / 13-14) switches. Past 20° CCW, contact 2 (21-22 / 23-24) switches. Levers not included.					
	26.6 oz-in	2 SPDT	(2 N.O. + 2 N.C.)	N	ZCKJ4104H7
Plunger Operated					
	Rod plunger 48 oz	SPDT	(N.O. + N.C.)	N	XCKJ1161H7
	Steel roller plunger 48 oz	SPDT	(N.O. + N.C.)	N	XCKJ1167H7

Exploded view [page 21-30](#)

[1] Direct opening contacts meet IEC 947-5-1 requirements for positive opening contacts.

XCKJ Bodies and Options

Table 21.55: Non-plug-in

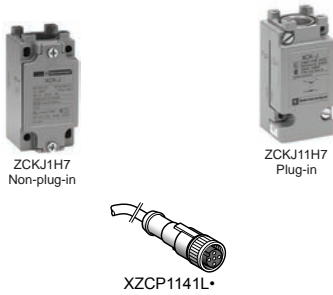

Silver Contacts (10 A)				Direct Opening	Catalog Number
1 Step	SPDT	(N.O. + N.C.)	Snap action	Y[2]	ZCKJ1H7
1 Step	SPDT	(isolated N.O. + N.C.)	Slow break-before-make	Y[2]	ZCKJ5H7
1 Step	2 SPDT	(2 N.O. + 2 N.C.)	Snap action	N	ZCKJ2H7
2 Step	2 SPDT	(2 N.O. + 2 N.C.)	Snap action	N	ZCKJ4H7
Gold Flashed Contacts (low power circuits max. 12 V, 0.1 A)					
1 Step	SPDT	(N.O. + N.C.)	Snap action	Y[2]	ZCKJ18H7
1 Step	2 SPDT	(2 N.O. + 2 N.C.)	Snap action	N	ZCKJ28H7
High Temperature: +248 °F (+120 °C)					
1 Step	SPDT	(N.O. + N.C.)	Snap action	Y[2]	ZCKJ15H7
1 Step	2 SPDT	(N.O. + N.C.)	Snap action	N	ZCKJ25H7
Neutral Position	2 SPDT	(2 N.O. + 2 N.C.)	Snap action	N	ZCKJ4045H7

Table 21.56: Plug-in

Silver Contacts (10 A)				Direct Opening	Catalog Number
1 Step	SPDT	(N.O. + N.C.)	Snap action	N	ZCKJ11H7
1 Step	2 SPDT	(2 N.O. + 2 N.C.)	Snap action	N	ZCKJ21H7
2 Step	2 SPDT	(2 N.O. + 2 N.C.)	Snap action	N	ZCKJ41H7
High Temperature: +248 °F (+120 °C)					
1 Step	SPDT	(N.O. + N.C.)	Snap action	N	ZCKJ115H7
1 Step	2 SPDT	(2 N.O. + 2 N.C.)	Snap action	N	ZCKJ215H7
Neutral Position	2 SPDT	(2 N.O. + 2 N.C.)	Snap action	N	ZCKJ41045H7

Table 21.57: Wiring Options

	Catalog Number	Pins	Suffix
Mini style male receptacle (For example, to order a ZCKJ1H7 body with a mini-style connector option, the part number is ZCKJ1547.)	ZCKJ1/J11/J5H7	5 pins	547
	ZCKJ2/J4/J21/J41H7	9 pins	947

Table 21.58: Plug and Cable Assemblies

Description	Cable Length	Pins	Matches Receptacle Option	Catalog Number
Plug and cable	3 ft	5	547	BH2053
	6 ft			BH2056
	12 ft			BH20512
Plug and cable	3 ft	9	947	BH2093
	6 ft			BH2096
	12 ft			BH20912
Pre-wired connector, female	6.56 ft	4	XCSDMR-L / XCSDMP-L	XZCP1141L2
	16.40 ft			XZCP1141L5
	32.81 ft			XZCP1141L10

Building a Complete Switch

Complete Switch = Body (with contact assembly)+ Head + Lever

Example:

$$\text{Body ZCKJ1H7} + \text{Head ZCKE05} + \text{Lever ZCKY11} = \text{XCKJ10511H7}$$

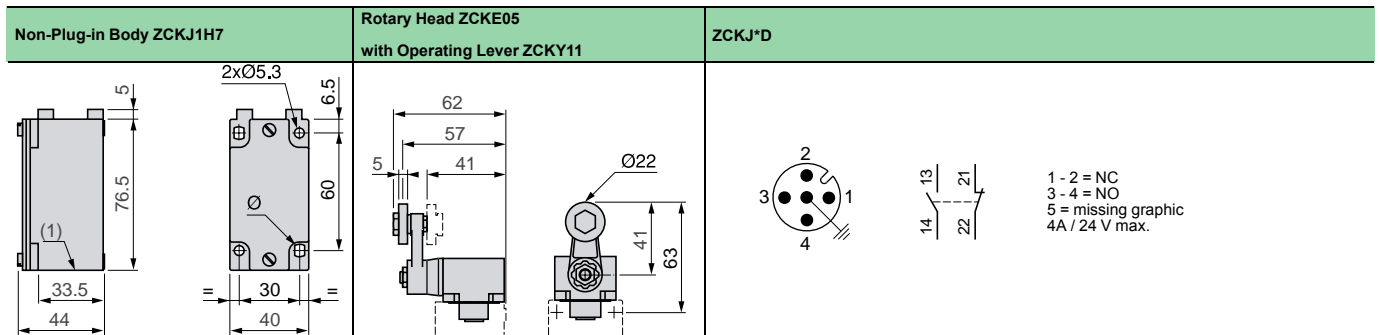

File E39281
CCN NKCR



File LR44087
Class 3211-03



Acceptable Wire Sizes: 14–24 AWG
Recommended Terminal Clamp Torque: 13 lb-in

[2] Direct opening contacts meet IEC 947-5-1 requirements for positive opening contacts when using head.

Operating Heads

Table 21.59: Lever-Operated Heads

Contact Operation with Switch Bodies:	1 Step	2 Step	1 Step	Operating Force/Torque	Catalog Number
	ZCKJ1[3] / J11 / J2 / J21H7	ZCKJ4 / J41H7	ZCKJ5H7 [3]		
Standard operation 1 Step CW and/or CCW				33 oz-in, 0.25 N	ZCKE05
2 Step 11-12, 13-14 first step					
21-22, 23-24 second step					
ZCKE05 Programming					
	CW and CCW	CW	CW and CCW	CCW	
Maintained operation				33 oz-in, 0.25 N	ZCKE09

NOTE: Neutral position head ZCKE04 is not available separately. Order the head and body subassemblies from page 21-30.

Table 21.60: Plunger-Operated Heads

Contact Operation with Switch Bodies:	1 Step	2 Step	1 Step	Operating Force/Torque	Catalog Number
	ZCKJ1[3] / J11 / J2 / J21 / H7	ZCKJ4 / J41H7	ZCKJ5H7 [3]		
Top rod plunger				48 oz 18 N	ZCKE61
Ball-bearing top plunger				48 oz 18 N	ZCKE66
Steel roller plunger				48 oz 18 N	ZCKE67
One-way Delrin roller based on actuation by 30° cam				48 oz 18 N	ZCKE21
One way steel roller based on actuation by 30° cam				48 oz 18 N	ZCKE23
Side rod plunger				48 oz 18 N	ZCKE63
Side steel roller-plunger, horizontal based on actuation by 30° cam				48 oz 18 N	ZCKE64
Side steel roller-plunger, vertical based on actuation by 30° cam				48 oz 18 N	ZCKE65

[3] Direct opening when used with any head on this page except ZCKE09 (maintained operation).

XCKJ Accessories

Table 21.61: Omnidirectional Heads

Non-plug-in Style Contact Block



XE2SP2151



ZCKY11/13/14



ZCKY43/41



ZCKY51/52/53/59



ZCKY61



ZCKY71



ZCKY81



ZCKY91

Contact Operation with Switch Bodies:	1 Step	2 Step	1 Step	Operating Force/Torque	Catalog Number
	ZCKJ1, J11, J2, J21	ZCKJ4, J41	ZCKJ5		
Cat whisker-steel [4]				18.4 oz-in, 0.13 N	ZCKE06
Wobble coil springs [4]				18.4 oz-in, 0.13 N	ZCKE08

Table 21.62: Operating Heads—for extended temperature ranges

Description	Catalog Number	
	Low temperature [5] -40 °F to +158 °F (-40 °C to +70 °C)	High temperature [5] -13 °F to +248 °F (-25 °C to +120 °C)
Lever operated	Standard operations	ZCKE056
	Maintained operations	ZCKE096
Plunger operated	Top rod plunger	ZCKE616
	Ball-bearing top plunger	ZCKE666
	Top roller plunger	ZCKE676
	One way Delrin roller	ZCKE216
	One way steel roller	ZCKE236
	Side rod plunger	ZCKE636
Omnidirectional	Side steel roller plunger-horizontal	ZCKE646
	Side steel roller plunger-vertical	ZCKE656
	Cat whisker	ZCKE066
	Wobble coil spring	ZCKE086

Table 21.63: Replacement Parts

Description	Direct Opening	Catalog Number
(see page 21-30 for contact description)		
Contact block for ZCKJ1H7	Y	XE2SP2151
Contact block for ZCKJ2H7	N	XESP2021
Contact block for ZCKJ4H7	N	XESP2031
Contact block for ZCKJ5H7	Y	XE2NP2151
Contact block for ZCKJ18H7 (gold flashed)	Y	XE2SP2158
Contact block for ZCKJ28H7 (gold flashed)	N	XESP2028
Plug-in module for ZCKJ11H7 (includes contact block)	N	ZCKJ01H7
Plug-in module for ZCKJ21 (includes contact block)	N	ZCKJ02H7
Plug-in module for ZCKJ41 (includes contact block)	N	ZCKJ04H7
Base receptacle for ZCKJ11H7	—	ZCKJ019H7
Base receptacle for ZCKJ21H7	—	ZCKJ029H7
Base receptacle for ZCKJ41H7	—	ZCKJ029H7

Table 21.64: Lever Arms

Description	Adjustment Increments	Catalog Number
Adjustable or Flexible Operators [6]		
Adjustable Delrin roller, 0.74 in. diameter, 0.2 in. wide, 3 in. long (max.)	5° or 90°	ZCKY41
Adjustable steel roller, 0.74 in. diameter, 0.2 in. wide, 3 in. long (max.)	5° or 90°	ZCKY43
Adjustable rod-square, steel, 1/8 in. side, 5.4 in. long (max.)	5° or 45°	ZCKY51
Adjustable rod-round, fiberglass, 1/8 in. diameter, 5.4 in. long (max.)	5° or 45°	ZCKY52
Adjustable rod-round, steel, 1/8 in. diameter, 5.4 in. long (max.)	5° or 45°	ZCKY53
Adjustable rod-round, plastic, 1/4 in. diameter, 8.4 in. long (max.)	5° or 45°	ZCKY59
Coil spring lever	5° or 90°	ZCKY81
Spring rod lever	5° or 90°	ZCKY91
Reverse Mounting		
Delrin roller 0.9 in. diameter, 0.2 in. wide, 1.6 in. long	5° or 45° [7]	ZCKY11
Steel roller 0.9 in. diameter, 0.2 in. wide, 1.6 in. long	5° or 45° [7]	ZCKY13
Ball bearing roller 0.9" diameter, 0.2 in. wide, 1.6 in. long	5° or 45° [7]	ZCKY14
Fork, 2 track, Delrin roller, 0.9 in. diameter, 0.2 in. wide for ZCK-E09	5° or 45° [7]	ZCKY61
Fork, 1 track, Delrin roller, 0.9 in. diameter, 0.2 in. wide for ZCK-E09	5° or 45° [7]	ZCKY71

[4] Flexible operators do not guarantee direct (positive) opening operation.

[5] The minimum temperatures listed are based on the absence of freezing moisture or water.

[6] Adjustable and flexible operators do not guarantee positive opening operation.

[7] Reverse mounting: The higher increment (45°) is a direct (positive) opening contact feature which ensures no loss of mechanical effort between the actuation point and the moving contact bridge of the direct (positive) contact (N.C.) even if the lever is loosely mounted.

Overview — 9007C Adaptable Sub-Assemblies

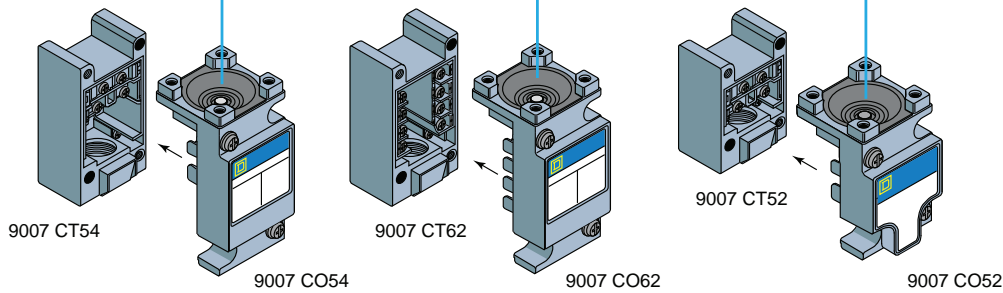
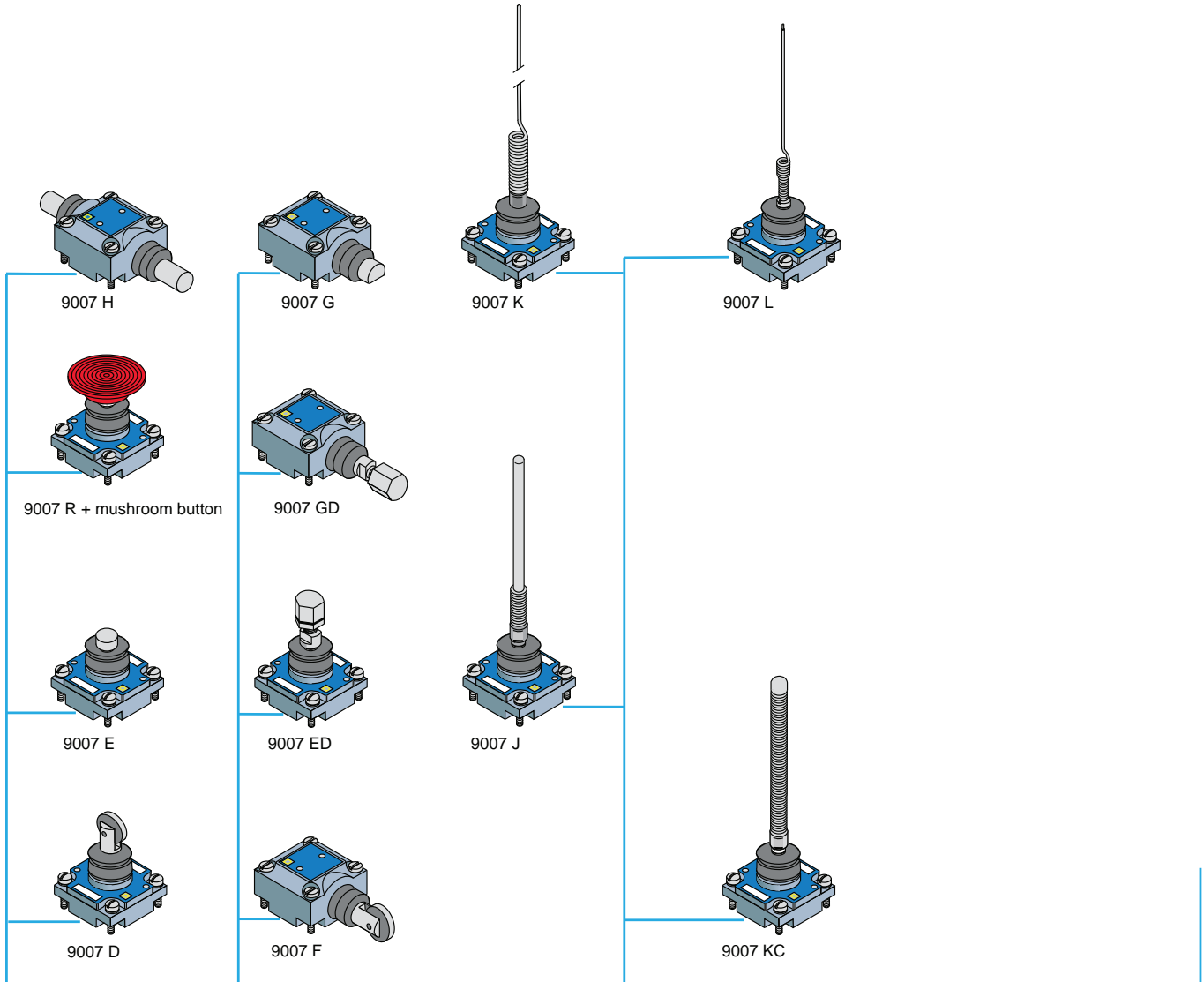



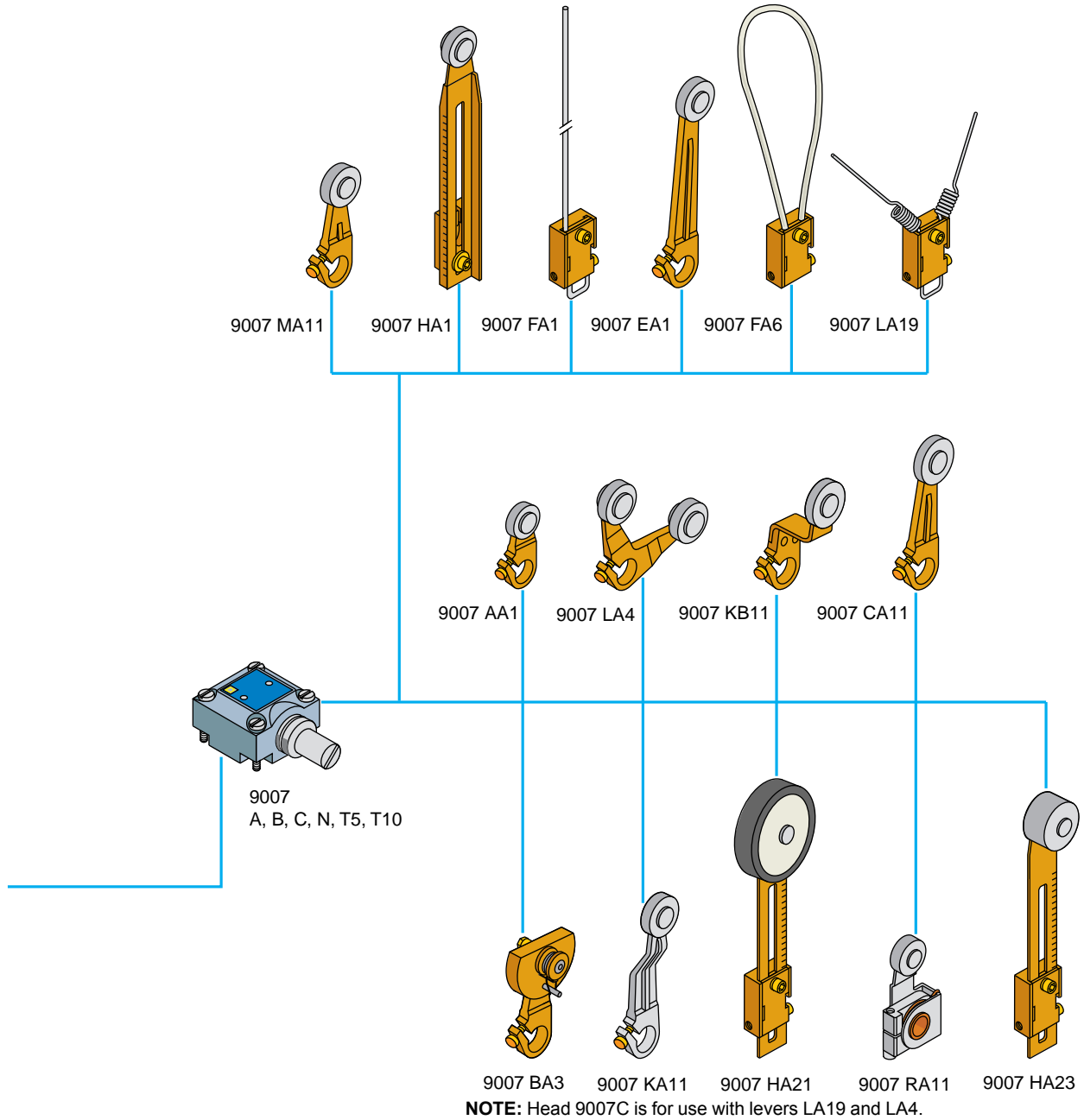

NOTE: Order the mushroom operator cap from [page 21-39](#).

Overview—Head 9007C Lever Switches

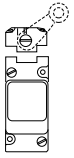

Oiltight, Watertight Switches—Standard and Compact Bodies

Table 21.65: All Type C Switches—Standard and Compact Bodies

Select Turret Head		Rotary Lever Arm					Side Plunger				
	Standard Pre-travel Spring Return	Low Differential Spring Return	Neutral Position		Light Operating Torque Spring Return	Maintained Contact	Side Roller-Plunger Spring Return Vertical Roller Type [1]	Side Push-Rod Plunger Spring Return	Side Push-Rod Plunger Adjustable Spring Return [2]	Side Push-Rod Plunger Maintained Contact	
	CW & CCW [3]	CW & CCW [3]	CW & CCW	CW & CCW	CW & CCW [3]	CW (Trip) CCW (Reset)					
Select Basic Switch	Contacts	Type (Class 9007)									
Standard Box Plug-in	1 N.O. 1 N.C.	C54B2	C54A2	—	—	C54N2	C54C	C54F	C54G	C54GD	C54H
	2 N.O. 2 N.C.	C62B2	C62A2	—	—	C62N2	C62C	C62F	C62G	C62GD	C62H
	2 N.O.—2 N.C. Neutral Position	—	—	C68T10	C68T5	—	—	—	—	—	—
	2 N.O.—2 N.C. Two Stage	C66B2	C66A2	—	—	C66N2	—	C66F	C66G	C66GD	—
Compact Box Plug-in	1 N.O. 1 N.C.	C52B2	C52A2	—	—	C52N2	C52C	C52F	C52G	C52GD	C52H
	2 N.O.—2 N.C. Neutral Position	—	—	CR67T10	CR67T5	—	—	—	—	—	—
UL Listed for Hazardous Location Division I Class I Groups B, C, D Class II Groups E, F, G	1 N.O. 1 N.C.	CR53B2	CR53A2	—	—	CR53N2	CR53C	CR53F	CR53G	CR53GD	CR53H
	2 N.O. 2 N.C.	CR61B2	CR61A2	—	—	CR61N2	CR61C	CR61F	CR61G	CR61GD	CR61H
Head Only (Example: 9007B)	2 N.O.—2 N.C. Two Stage	—	—	CR67T10	CR67T5	—	—	—	—	—	—
		B	A	T10	T5	N	C	F	G	GD	H
Nominal Operating Data	Pre-travel	10°	5°	10°	5°	10°	45°	0.08 in. (2 mm)		0.14 in. (3.6 mm)	
	Pre-travel Two Stage	First Stage	10°	5°	—	—	10°	—	0.08 in. (2 mm)		—
		First to Second Stage	2-1/2°	1-1/2°	—	—	2-1/2°	—	0.02 in. (0.5 mm)		—
	Total Travel	90°	90°	90°	90°	90°	90°	0.25 in. (6.3 mm)		0.25 in. (6.3 mm)	
	Differential	4°	2°	4°	2°	4°	—	0.03 in. (0.8 mm)		—	
	Reverse Overtravel	90°	90°	90°	90°	90°	—	—		—	
	Operating Torque/Force—1 Pole & 2 Pole	4 lb-in (0.45 N•m)	4 lb-in (0.45 N•m)	4 lb-in (0.45 N•m)	4 lb-in (0.45 N•m)	25 oz-in (0.18 N•m)	3 lb-in (0.34 N•m)	4 lb (0.45 N•m)		7 lb (0.80 N•m)	
Repeat Accuracy—Linear travel of cam (1-1/2 in. lever arm)	± 0.002 in. (0.05 mm)	± 0.001 in. (0.03 mm)	± 0.002 in. (0.05 mm)	± 0.002 in. (0.05 mm)	± 0.002 in. (0.05 mm)	± 0.002 in. (0.05 mm)	0.001 in. (0.3 mm)		—		

NOTE: CW = clockwise; CCW = counter-clockwise

Acceptable Wire Sizes: 12–22 AWG.
Recommended Terminal Clamp Torque: 7 lb-in (0.80 N•m)

Mode Change—Lever Arm Type

Mode of operation is easily convertible to clockwise, counterclockwise, or both. Simply point the arrow to the letters representing the desired direction—CW, CCW, or CW/CCW. All parts are captive.

Exploded view [page 21-36](#), Rotary Head Lever Arms, [page 21-37](#)

Lever arms [page 21-9](#), [page 21-40](#), [page 21-41](#)

Electrical ratings [page 21-5](#)

Special features [page 21-41](#), [page 21-42](#)

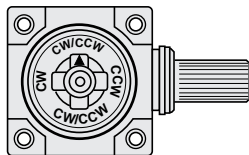

[1] Can be converted to horizontal roller type in the field. To order horizontal roller version add the letter "H" at the end of the equivalent vertical roller version type number (Example: C54F would become C54FH).

[2] To lock the nut in the desired position, crimp the slot near the bottom of the nut.

[3] These devices are factory set to operate the contacts in both the CW and CCW directions. Mode of operation is field convertible to CW only or CCW only. To order factory converted devices—for CCW only operation, change the "2" at the end of the type number to "1" (Example: C54B2 becomes C54B1); for CW only operation, delete the "2" at the end of the type number (Example: C54B2 becomes C54B).

Type C Switches

Table 21.66: All Type C Switches Rated NEMA 6P And UL Type 6P

Select Turret Head		Top Plunger				Wobble Stick			Plug-In		
		Top Roller-Plunger Spring Return	Top Push-Rod Plunger Spring Return	Top Push-Rod Plunger Adjustable Spring Return	Palm Operated	Wobble Stick Delrin Extension	Wobble Stick Wire Extension	Wobble Stick Coil Spring Extension	Cat Whisker	Plug-in Unit without Head	Plug-in Receptacle Only
Select Basic Switch	Contacts	Type (Class 9007)									
Standard Box Plug-in	1 N.O. 1 N.C.	C54D	C54E	C54ED	C54R	C54J	C54K	C54KC	C54L	CO54	CT54
	2 N.O. 2 N.C.	C62D	C62E	C62ED	—	C62J	C62K	C62KC	C62L	CO62	CT62
	2 N.O.–2 N.C. Neutral Position	—	—	—	—	—	—	—	—	CO68	CT62
	2 N.O.–2 N.C. Two Stage	C66D	C66E	C66ED	—	C66J	C66K	C66KC	C66L	CO66	CT62
Compact Box Plug-in	1 N.O. 1 N.C.	C52D	C52E	C52ED	C52R	C52J	C52K	C52KC	C52L	CO52	CT52
UL Listed for Hazardous Location Division I Class I Groups B, C, D Class II Groups E, F, G	1 N.O. 1 N.C.	CR53D	CR53E	CR53ED	CR53R	CR53J	CR53K	CR53KC	CR53L	—	—
	2 N.O. 2 N.C.	CR61D	CR61E	CR61ED	CR61R	CR61J	CR61K	CR61KC	CR61L	—	—
	2 N.O.–2 N.C. Neutral Position	—	—	—	—	—	—	—	—	—	—
	2 N.O.–2 N.C. Two Stage	CR65D	—	CR65ED	—	CR65J	CR65K	CR65KC	—	—	—
Head Only		D	E	ED	R [5]	J	K	KC	L	—	—
Nominal Operating Data	Pre-travel	0.08 in. (2 mm)				10° (Any Direction)			20°		
	Pre-travel First Stage	0.08 in. (2 mm)				10° (Any Direction)			20°		
	Pre-travel Two Stage	0.01 in. (0.06 mm)				4°			5°		
	Total Travel	0.25 in. (6.3 mm)				90°			90°		
	Differential	0.02 in. (0.5 mm)				3°			6°		
	Reverse Overtravel	—				—			—		
	Operating Torque/ Force— 1 Pole and 2 Pole	3 lbs. (0.34 N•m)				3 lb-in (0.34 N•m)			7 oz-in (0.05 N•m)		
	Repeat Accuracy — Linear travel of cam	± 0.001 in. (0.03 mm)				—			—		

Acceptable Wire Sizes: 12–22 AWG
Recommended Terminal Clamp Torque: 7 lb-in (0.80 N•m)

Table 21.67: Mushroom Button For Palm Operated Turret Head

Color	Catalog No.	
	1-3/8 in. Dia. Button	2-1/4 in. Dia. Button
Black	2358C6G3	2358C22G2
Red	2358C6G2	2358C22G3
Green	—	2358C22G6

Table 21.68: Wobble Stick Extensions

Description	Catalog Number
Delrin extension	9007WJ
Wire extension	9007WK
Coil spring extension	9007WKC

Type C  File CCN E78403 NKCR  File Class LR25490 3211-03 

Type CR  File CCN E10054 NOIV  File Class LR26817 3218-02



[4] To lock the nut in the desired position, crimp the slot near the bottom of the nut.
 [5] Mushroom button must be ordered separately. See Table 21.67.
 [6] Delrin® is a registered trademark of DuPont. Not for use outdoors.
 [7] Wobble stick extensions are available separately as replacements for complete devices. See Table 21.68.

Lever Arms for 9007AW and 9007C Heavy Duty / Industrial Limit Switches

Standard roller is hardened oil-impregnated sintered iron. Bold-face Catalog Numbers indicate the most commonly used lever arms.

Table 21.69: Cast Zinc Lever Arms

	Length of Arm (A)	Catalog Number							
		Roller Style							
		Standard 3/4" Dia. (B) 1/4" Wide (C)	Standard 3/4" Dia. (B) 5/8" Wide (C)	Standard 5/8" Dia. (B) 1/4" Wide (C)	Standard 5/8" Dia. (B) 5/8" Wide (C)	Nylon 3/4" Dia. (B) 1/4" Wide (C)	Nylon 5/8" Dia. (B) 1/4" Wide (C)	Nylon 5/8" Dia. (B) 5/8" Wide (C)	Nylon [8] 1" Dia. (B) 5/8" Wide (C)
	7/8"	—	—	9007AA1	9007AA2	—	—	9007AA17	—
	1-3/8"	9007BA11	9007BA12	9007BA1	9007BA2	9007BA18	9007BA8	9007BA17	9007BA13
	1-1/2"	9007MA11	9007MA12	9007MA1	9007MA2	9007MA18	9007MA8	9007MA17	9007MA13
	2"	9007CA11	9007CA12	9007CA1	9007CA2	9007CA18	9007CA8	9007CA17	9007CA13
	2-1/2"	9007DA11	9007DA12	9007DA1	9007DA2	9007DA18	9007DA8	9007DA17	9007DA13
	3"	9007EA11	9007EA12	9007EA1	9007EA2	9007EA18	9007EA8	9007EA17	9007EA13
	Length of Arm (A)	Nylon 1" Dia. (B) 1/4" Wide (C)	Ball Bearing 1 1/16" Dia. (B) 1/4" Wide (C)	Standard 3/4" Dia. (B) 1/4" Wide (C) Roller on Opposite Side to Standard	Standard 5/8" Dia. (B) 1/4" Wide (C) Roller on Opposite Side to Standard	Standard 5/8" Dia. (B) 5/8" Wide (C) Roller on Opposite Side to Standard	Without Roller	Standard 3/4" Dia. (B) 1/4" Wide (C), Countersunk Roller Pin	Cable Operated With Eyebolt (3/8" I.D.) Instead of Roller
	7/8"	—	9007AA9	—	9007AA5	9007AA6	9007AA0	—	—
	1-3/8"	9007BA4	9007BA9	9007BA15	9007BA5	9007BA6	9007BA0	—	—
	1-1/2"	9007MA4	9007MA9	9007MA15	9007MA5	9007MA6	9007MA0	9007MA31	9007MA22
2"	9007CA4	9007CA9	9007CA15	9007CA5	9007CA6	9007CA0	9007CA31	—	
2-1/2"	9007DA4	9007DA9	9007DA15	9007DA5	9007DA6	9007DA0	9007DA31	—	
3"	9007EA4	9007EA9	9007EA15	9007EA5	9007EA6	9007EA0	—	—	

Cast Zinc Lever Arm Dimensions

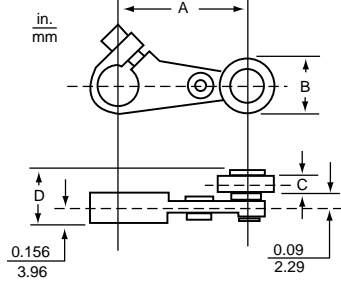

A = Length of Lever Arm
 B = Roller Diameter
 C = Roller Width
 D = C + 5/16"

See the tables in this topic for A, B, and C dimensions.



Table 21.70: Flat Steel Lever Arms

Length of Arm (A)	Catalog Number				
	Roller Style				
	Standard 5/8" Dia. (B) 1/4" Wide (C)	Standard 5/8" Dia. (B) 5/8" Wide (C)	Nylon 3/4" Dia. (B) 1/4" Wide (C)	Nylon 1" Dia. (B) 1/4" Wide (C)	No Roller
7/8"	9007AA1S	9007AA2S	—	—	—
1-3/8"	9007BA1S	9007BA2S	—	9007BA4S	—
1-1/2"	—	—	9007MA18S	—	—
2"	9007CA1S	9007CA2S	—	9007CA4S	9007CA0S
2-1/2"	9007DA1S	9007DA2S	—	9007DA4S	9007DA0S
3"	9007EA1S	9007EA2S	—	9007EA4S	9007EA0S

Table 21.71: 90° Forked Cast Zinc Lever Arms

Roller Position	Catalog Number				
	Roller Style				
	Standard 3/4" Dia. (B) 1/4" Wide (C)	Standard 5/8" Dia. (B) 1/4" Wide (C)	Nylon 3/4" Dia. (B) 1/4" Wide (C)	Nylon 3/4" Dia. (B) 1" Wide (C)	Ball Bearing 1 1/16" Dia. (B) 1/4" Wide (C)
Rollers on Same Side	9007LA4	9007LA1	9007LA16	9007LA10	9007LA7
R.H. Roller on Opposite Side	9007LA5	9007LA2	9007LA17	9007LA11	—
L.H. Roller on Opposite Side	9007LA6	9007LA3	9007LA18	9007LA12	9007LA9

Approximate shipping weights range from 1/8 to 1/4 lb.

Table 21.72: One-Way Cast Zinc Roller Lever Arm

	Length of Arm	Catalog Number	
		Roller, 1-1/4" Dia. (B) 1/4" Wide (C)	
		Cast Arm	Flat Steel Arm
	1-3/8"	9007BA3	9007BA3S
	1-1/2"	9007MA3	—
	2"	9007CA3	9007CA3S
	2-1/2"	9007DA3	9007DA3S
	3"	9007EA3	9007EA3S

Table 21.73: Offset-style Cast Zinc Lever Arms

Offset Lever Arm	Roller	Dia. (B)	Width (C)	Catalog Number
2" Length 7/16" Offset	Standard	5/8	1/4	9007KA1
		5/8	5/8	9007KA2
		3/4	1/4	9007KA11
		3/4	5/8	9007KA12
	Ball Bearing	11/16	1/4	9007KA9
1-1/2" Length 7/8" Offset	Nylon	3/4	1/4	9007KA18
		3/4	1	9007KA21
	Standard	3/4	1/4	9007KB11
		3/4	1/4	9007KB15 [9]

Table 21.74: One-Way Lever Arms

	Length of Arm	Catalog Number			
		Roller Style			Rod Type
		Standard 3/4" Dia. (B) 1/4" Wide (C)	Nylon 3/4" Dia. (B) 1/4" Wide (C)	Ball Bearing 1-1/16" Dia. (B) 1/4" Wide (C)	
	1-1/2"	9007RA11	9007RA18	9007RA9	—
	5"	—	—	—	9007FA2

Table 21.75: Rod Type Lever Arms

Rod, in. (mm)	Catalog Number
10 (254) Stainless Steel Rod	9007FA1
12 (304) Spring Rod, Steel	9007FA3
18 (304) Spring Rod, Steel	9007FA4
12 Spring Rod, Delrin	9007FA5
Looped Delrin Rod	9007FA6
90° Forked Rod, 2-1/2" Spring Rods, Steel	9007LA19

Dimensions: page 21-41. For more information on LA19, refer to catalog 9006CT1007.

[8] Recommended in place of Types BA7, CA7, DA7, EA7 and MA7 lever arms with steel rollers. If necessary, the latter arms can be furnished at an additional cost.

[9] Roller inside.

Lever Arms

Standard roller is hardened oil-impregnated sintered iron.
Bold-face Type numbers indicate the most commonly used lever arms.

Table 21.76: Lever Arm, Adjustable Length from 7/8" to 4"

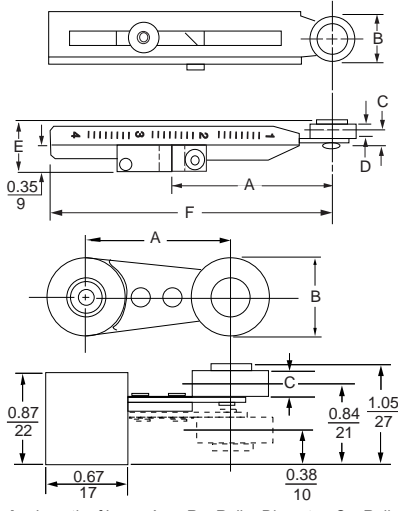

A = Length of Lever Arm; B = Roller Diameter; C = Roller Width

Style	Type (Class 9007)								
	No Roller	Roller							
		Standard 5/8" Dia. 1/4" Wide	Standard 5/8" Dia. 5/8" Wide	Nylon 5/8" Dia. 1/4" Wide	Ball Brg. 11/16" Dia. 1/4" Wide	Nylon [10] 1" Dia. 5/8" Wide	Delrin 1-5/8" Dia. 1/4" Wide	Nylon 2" Dia. 1/4" Wide	Rubber Tire 2-1/8" Dia. 1/2" Wide
Non-bendable	HA0	HA1	HA2	HA4	HA24	HA22	—	—	—
Bendable	HA9	HA5	HA6	HA8	HA25	HA23	HA20	HA26	HA21

Table 21.77: 360° Angular Adjustable Lever Arms

Length of Arm	Catalog Number				
	Standard 5/8" Dia. 1/4" Wide	Standard 3/4" Dia. 1/4" Wide	Nylon 5/8" Dia. 1/4" Wide	Nylon 3/4" Dia. 1/4" Wide	Ball Bearing 11/16" Dia. 1/4" Wide
	Roller Outside	Roller Inside	Roller Outside		Roller Outside
7/8"	9007AA1M	—	—	9007AA8M	—
1-3/8"	9007BA1M	9007BA5M	9007BA11M	—	—
1-1/2"	9007MA1M	9007MA5M	9007MA11M	—	9007MA18M
2"	9007CA1M	9007CA5M	9007CA11M	9007CA8M	—
2-1/2"	9007DA1M	—	9007DA11M	—	9007DA18M
3"	9007EA1M	9007EA5M	9007EA11M	9007EA8M	9007EA18M

NOTE: Roller can be changed in the field from roller outside to roller inside position or vice versa.
Approximate shipping weights range from 1/8 to 1/4 lb.

Special Features

Table 21.78: Special Features (do not apply to Type CR unless noted)—Field Installable

Description	Part Number
Conduit Seal Only	
Conduit seal fits in conduit entrance and excludes liquids	5 hole seal 9 hole seal
	3103248801 3103281501
Adapters	
Switch with adapter plate permitting substitution of any Type C switch with standard box for any Type T switch with Style B baseplate	Form Y147
Adapter plate kit only (plate plus mounting screws) for above	9007BT1
Adapter plate for direct substitution of Type C plunger switches for Type B plug-in plunger switches— use only if there is a problem in lining up cam tracks	Standard Box
	9007CT10 [11]
Metric conduit-connection adapter—male 1/2" NPT on one end, female 20 mm on the other end	9007CT12

Rotary lever arms

9007C*** A, B, C, N, T5, T10

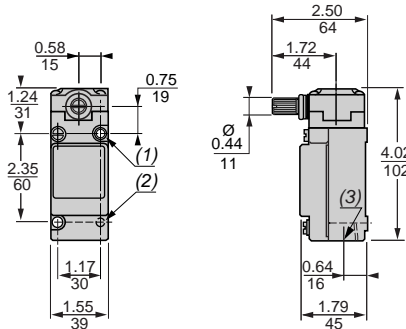

Dual dimensions:
in. / mm

- 2 x 0.20/5 x 0.22/6 HLS.
- 2 x 10-24 Tapped HLS Back Mtg 0.29/7 DP.
- 1/2 14 NPT.

Rod type lever arms

9007FA1

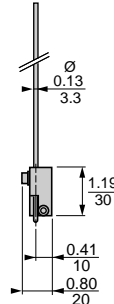
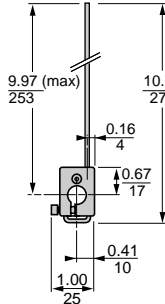

9007FA9

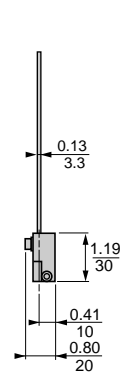
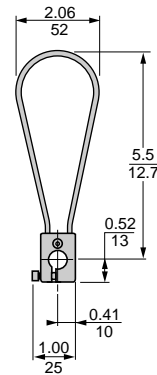





[10] Recommended in place of Types HA3 and HA7 lever arms with steel rollers. If necessary these arms can be furnished at an additional cost.

[11] Dimensions: 0.22 x 2.94 x 1.54 in.

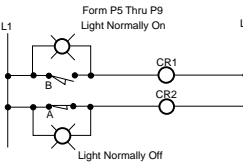
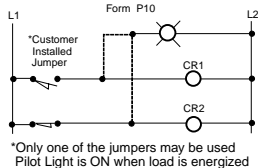
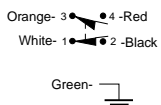
Factory Modifications

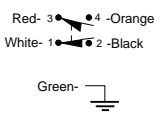
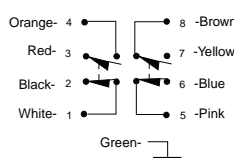
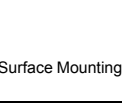







Table 21.79: Special Features (do not apply to Type CR unless noted)—Not Field Installable, Except Where Noted







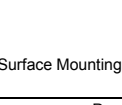

Special Features	Form
<p>Optional Shaft Equipped With 9007T / 9007FT Hub: Any lever arm Type C, CF, or CR switch can be furnished with an optional shaft and hub combination which will accept the lever arms normally used with Type T and FT limit (position) switches. To order, add S9 as suffix to the device type number. For example, to order a 9007C54B2 with this modification, order as 9007C54B2S9. For details about the switches and lever arms that can be furnished with this modification, see catalog 9007CT1007.</p> <p>Hub</p> <p>Hub Only: Can be field installed on any Type C lever type switch.</p> 	<p>Add S9 as a suffix to the catalog number</p> <p>Cat. No. 9007S9</p>
<p>LED Pilot Light, 24–120 Vac or Vdc on Plug-In Type Switch (Type C52, C54, C62, C64, C66, or C68):</p> <div style="display: flex; justify-content: space-around;"> <div style="text-align: center;"> <p>Form P5 Thru P9 Light Normally On</p>  </div> <div style="text-align: center;"> <p>Form P10 *Customer Installed Jumper</p>  <p>*Only one of the jumpers may be used Pilot Light is ON when load is energized</p> </div> </div>	<p>Addition of LED pilot light in parallel with N.O. contact (light normally on) P5</p> <p>Addition of LED pilot light in parallel with N.C. contact (light normally off) P6</p> <p>Addition of one isolated LED pilot light (light on when load is energized) (Type C54 only. Not available with Y1901.) P10</p>
<p>Pre-Wired Receptacle Single Pole</p>	<p>Plug-in limit (position) switch with pre-wired mini 5 pin male receptacle. For use with Brad Harrison female portable plug No. 41306, 41307, or 41308 (or equal). (Not available with P10 or for hazardous locations.) Y1901</p> <p>Same as Y1901 but with different wire color coding Y1905</p>
<p>Other versions with different wiring diagrams per automotive requirements are available. Contact your local Schneider Electric field office.</p> <p style="text-align: center;">Wiring Diagrams Form Y190_</p>	
<p>Mating plug and cables available.</p>	<div style="display: flex; justify-content: space-around;"> <div style="text-align: center;"> <p>Forms Y1901</p>  </div> <div style="text-align: center;"> <p>Form Y1905</p>  </div> </div> 
<p>Potted Limit (Position) Switch or Plug-In Receptacle Only: With Individual Wires</p> <ul style="list-style-type: none"> Single pole plug-in limit (position) switch or receptacle pre-wired with five #16 wires 5 ft long and wire entry completely sealed with epoxy resin 	Y1841
<p>With STOWA Cord</p> <ul style="list-style-type: none"> Single pole plug-in limit (position) switch or receptacle pre-wired with five conductor #16 STOWA cord 8 ft long and wire entry completely sealed with epoxy resin Double pole plug-in limit (position) switch or receptacle pre-wired with nine conductor #16 STOWA cord 8 ft long and wire entry completely sealed with epoxy resin 	Y1851 Y1852
<p>Other versions with different wiring diagrams for automotive requirements are available.</p> <div style="display: flex; justify-content: space-around;"> <div style="text-align: center;"> <p>Form Y1851</p>  </div> <div style="text-align: center;"> <p>Form Y1852</p>  </div> </div>	
<p>Low Temperature—Lever Types Only: Limit (Position) switch will operate in an ambient temperature range of -40 to +185 °F (standard limit switch ambient temperature range is -20 to +185 °F). Minimum temperature is based on the absence of freezing moisture or water.</p>	Y128
<p>Fluorocarbon Rubber (FKM) Gaskets And Seals Substitute fluorocarbon rubber gaskets and seals on:</p> <ul style="list-style-type: none"> Lever arm type, standard box (shaft seals on lever arm types are fluorocarbon rubber as standard) Lever arm type, compact box (shaft seals on lever arm types are fluorocarbon rubber as standard) Plunger type, standard box Plunger type, compact box <p>NOTE: Fluorocarbon rubber has been shown to resist sunlight aging problems.</p>	Y140
<p>Direct Acting Contacts [12] Substitution of direct acting contact unit for snap switch of single-pole switch: One pole, normally closed, slow-make slow-break, direct acting contact mechanism substituted for standard snap switch on Types C52, C54, CF53, and CR53 devices. This mechanism was designed for use in emergency overtravel applications. The movable contact of this basic switch unit is acted upon directly by the actuating mechanism of the limit switch—it does not depend on the force exerted by a snap-switch blade or a spring to open the circuit. Because these contacts are slow-make slow-break, they are best suited for applications where they are not actuated during normal operation, but only if abnormal overtravel is encountered.</p>	 <p>Direct Acting Contact Mechanism (shown without cover)</p> <p>Y1561</p>

[12] The direct acting contacts described above come standard on the 9007CLS1 hoist overtravel switch.

Selection

Table 21.80: Complete with Base Plate, Without Lever Arm (bold type numbers indicate the most commonly used switches)

		Universal Type						
		No. 1	No. 2	No. 3 [1]	No. 4	No. 5	No. 6	No. 7 [1]
	Select the Operating Sequence	Single-Pole Double-Throw Spring-Return CW Only	Single-Pole Double-Throw Spring-Return CW Only	Single-Pole Double-Throw Maintained Contact	Single-Pole Double-Throw Spring-Return Neutral Position	Single-Pole Double-Throw Spring-Return CCW Only	Single-Pole Double-Throw Spring-Return CCW Only	Single-Pole Double-Throw Maintained
	Select the Basic Switch	Initial Position and CCW A B O O O O CW A B O O O O	Initial Position and CCW Initial Position and CCW A B O O O O Intermediate Pos. CW A B O O Final Pos. CW A B O O O O	Spring return of arm to initial position, contact position maintained until operated in reverse direction CCW CW A B A B O O O O O O O O If high speed cam or snap-back is present use No. 12	Initial Position A B O O O O CCW CW A B A B O O O O O O O O	Initial Position and CW A B O O O O CCW A B O O O O	Initial Position and CW A B O O O O Intermediate Position CCW A B O O Final Position CCW A B O O O O	If high speed cam or snap-back is present use No. 12 A B O O O O O O CW A B O O O O
	Base Plate	Catalog Number						
	Surface Mounting	A 9007TUA1 B 9007TUB1 C 9007TUC1 D 9007TUD1	— 9007TUB2 — —	9007TUA3 9007TUB3 9007TUC3	9007TUA4 9007TUB4 9007TUC4 9007TUD4	9007TUA5 9007TUB5 9007TUC5 9007TUD5	— 9007TUB6 — —	— 9007TUB7 — 9007TUD7
Nominal Operating Data	Pre-travel	14°	Int. Pos. 9°, Final 16°	7°	6°	14°	Int. Pos. 9°, Final 16°	10°
	Total-travel	88°	88°	81°	81°	88°	88°	85°
	Differential	12°	5°	7°	5°	12°	5°	12°
	Oper. Torque	12 lb-in	12 lb-in	12 lb-in	12 lb-in	12 lb-in	12 lb-in	2.5 lb-in
Repeat Accuracy [2]		±0.004 in.	±0.004 in.	±0.004 in.	±0.004 in.	±0.004 in.	±0.004 in.	±0.004 in.
To convert sequences, remove the base plate, positioning plate and latches. Reassemble the positioning plate and latches as shown.								 [3]

		Universal Type					Standard Type		
		No. 8 [1]	No. 9	No. 10	No. 11	No. 12	No. 1	No. 2	No. 3
	Select the Operating Sequence	Single-Pole Maintained Double-Throw Neutral Position	Single-Pole Double-Throw Spring-Return Slow Make Slow Break	Single-Pole Double-Throw Spring-Return Slow Make Slow Break	Single-Pole Double-Throw Spring-Return Slow Make Slow Break	Single-Pole Double-Throw Maintained	Single-Pole Double-Throw Spring-Return CW & CCW	Single-Pole Double-Throw Spring-Return CW & CCW	Single-Pole Double-Throw Spring-Return CW & CCW Slow Make Slow Break
	Select the Basic Switch	Initial Position If high speed cam or snap-back is present use No. 12 A B O O O O CCW CW A B A B O O O O O O O O	Initial Position and CCW A B O O O O CW A B O O O O	Initial Position A B O O O O CCW CW A B A B O O O O O O O O	Initial Position and CW A B O O O O CCW A B O O O O	CCW A B O O O O CW A B O O O O	Initial Position A B O O O O CCW & CW A B O O O O	Initial Position A B O O O O CW & CCW Intermediate Position A B O O Final Position A B O O O O	Initial Position A B O O O O CW & CCW A B O O O O
	Base Plate	Catalog Number							
	Surface Mounting	A 9007TUB8 B — C — D —	— 9007TUB9 — —	— 9007TUB10 — —	— 9007TUB11 — —	— 9007TUB12 9007TUC12 9007TUD12	9007TSA1 9007TSB1 9007TSC1 9007TSD1	— 9007TSB2 — —	— 9007TSB3 — —
Nominal Operating Data	Pre-travel	6°	12°	3°	12°	45°	14°	Int. Pos. 9°, Final 16	9°
	Total-travel	81°	87°	81°	87°	90°	89°	89°	89°
	Differential	10°	0°	0°	0°	0°	12°	Int. Pos. 5.5°, Final 7.5°	5°
	Oper. Torque	2.5 lb-in	12 lb-in	12 lb-in	12 lb-in	8 lb-in	10 lb-in	10 lb-in	10 lb-in
Repeat Accuracy [2]		±0.004 in.	±0.004 in.	±0.004 in.	±0.004 in.	±0.004 in.	±0.004 in.	±0.004 in.	±0.004 in.
To convert sequences, remove the base plate, positioning plate and latches. Reassemble the positioning plate and latches as shown.		 [3]				Not Adjustable			

NOTE: For a Type FT Foundry Switch, change the T at the beginning of the equivalent Type number to FT (for example, 9007TUB1 changes to 9007FTUB1).
Lever arms [page 21-44](#)

[1] Sequence 3, 7, and 8 devices are available but are not recommended where high speed cams or lever arm snap-back is present. The application should be checked and No. 12 sequence substituted where possible.
[2] Linear travel of cam on 1-1/2 in. lever arm.
[3] Remove the spring from the positioning plate.

Class 9007 Type T and FT, Oiltight

Table 21.81: Lever Arms for Types T and FT Limit Switches or Type C with S9 Hub

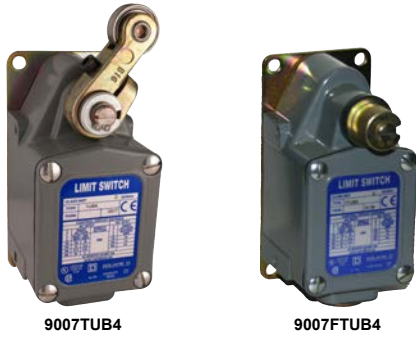

Type of Arm	Length of Arm (in.)	Description	Roller Width	Type		
				Roller Dia. (in.)		
				3/4	1	1-3/8
Straight	1-1/2	Front or Back	1/4	B1	B2	B3
	1-1/2	Front or Back	1/2	B12	B13	B14
	2-1/2	Front or Back	1/4	B7	B8	B9
	2-1/2	Front or Back	1/2	B22	B23	B24
	2-7/8	None	None	Without Roller B21	—	—
	5	Front or Back	1/4	B19	—	—
	Adj.	Does not include a lever arm clamp or rod. Lever arm clamp is required—use 9007 R16 or R17, plus a customer-supplied rod.	1/4	R18	R19	R20
Offset	1-1/2	Inside Offset	1/4	C1	C2	C3
	1-1/2	Outside Offset	1/4	D1	D2	D3
	1-7/8	Outside Offset	1/4	E4	E5	E6
120° Forked	1-1/2	Inside Offset	1/4	F4	F5	F6
	1-1/2	Rollers on Same Side	1/4	J1	J2	—
	1-1/2	LH Roller on Opposite Side	1/4	K1	K2	—
90° Forked	1-1/2	RH Roller on Opposite Side	1/4	N1	N2	—
	1-1/2	Rollers on Same Side	1/4	X1	X2	—
	1-1/2	RH Roller on Opposite Side	1/4	Y1	Y2	—
Cable Operated	1-1/2	None	None	Y3		—
	2-1/2	With eyebolt (1/4 in. I.D.) instead of roller	None	B27		—
Rod	Adj.	Clamp for 3/16 in. Rod (rod not included)	None	R16		—
	Adj.	Clamp for 1/4 in. Key Stock (key stock not included)	None	R17		—
Weld-On	3-1/2	None	None	G10		—
1-Way Roller	1-1/2	Outside Offset	1/4	D4		—
Conveyor Side Guide	8-7/16	1-1/2 in. dia. 3-3/4 in. Delrin roller. For use with Type T and FT only.		R21		—
		7/8 in. dia. 3-3/4 in. Delrin roller. For use with Type T, FT, or C with S9.		R22		—

Table 21.82: Separate Base Plates

Style	Mounting Holes	Part Number
A	None ^[4]	2934D32G1
B	End	2934D14G1
C	Side	2934D33G1
D	End	2934D34G1

For all Type T and FT:
Acceptable Wire Sizes: 14–18 AWG
Recommended Terminal Clamp Torque: 13–16 lb-in

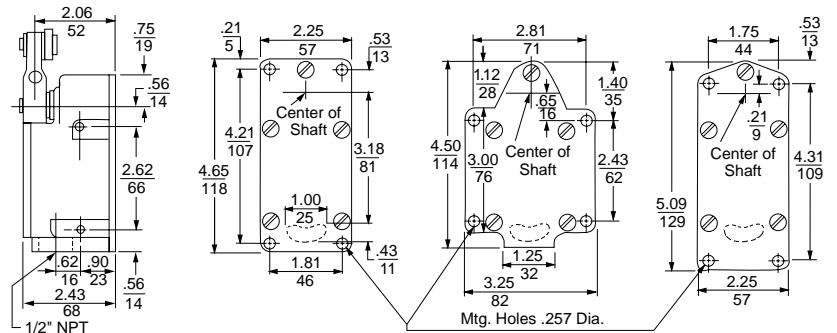

Style A Baseplate Shown

Style B

Style C

Style D

Dual Dimensions: INCHES
Millimeters



File 78403
CCN NKCR



File LR25490
Class 3211 03



[4] No mounting holes in base plate. Side mounting holes in switch case must be used.



L300WS2M1

R.B.Denison™ Lox-Switch™ L

Table 21.83: General Specifications

Temperature range	0 to +200 °F (-17 to +93 °C) standard. For high and low temperature options, see page 21-45 . Minimum temperatures are based on the absence of freezing moisture or water.
Enclosure rating	NEMA 1, 4, and 13; IP 65, 66
Vibration resistance	30G max. (10–55Hz)
Repeatability	0.03°
Cable entry	1/2" NPT standard double circuit, 3/4" NPT triple circuit
Contact Characteristics	
Rated thermal current	20 A
Rated insulation voltage	600 Vac and Vdc
Wire (max.)	1 x 12 AWG or 2 x 14 AWG per screw terminal

Table 21.84: Switching Ratings: A600 (AC), P600 (DC)

Contact Rating Designation (M=Make, B=Break)	Maximum current (A)												Maximum VA	
	120 V		125 V		240 V		250 V		480 V		< 600 V		M	B
A600 (AC)	60	6.00	—	—	30	3.00	—	—	15	1.50	12	1.20	7200	720
P600 (DC)	—	—	1.1	1.1	—	—	0.55	0.55	—	—	0.2	0.2	138	138

Mounting Plates, L100 and L300 Models

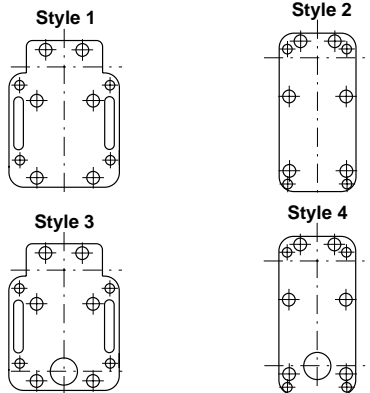

Table 21.85: Type L Selection

Select L100 for a standard (mill) switch and L300 for an extra heavy duty (foundry) switch

Description	Contact Diagram	Operating Torque	Cat. No.
Snap-action CW Spring return		190 oz-in (1.34 N·m)	L100WS2M1
		190 oz-in (1.34 N·m)	L300WS2M1
Snap-action CCW Spring return		190 oz-in (1.34 N·m)	L100WS2M2
		190 oz-in (1.34 N·m)	L300WS2M2
Maintained contact CW and CCW Snap action ^[5]		45 oz-in (0.32 N·m)	L100WS2M3
		45 oz-in (0.32 N·m)	L300WS2M3
Snap action CW Spring return		190 oz-in (1.34 N·m)	L100WDR2M4
		190 oz-in (1.34 N·m)	L300WDR2M4
Neutral position N.O.-CW, N.O.-CCW Spring return Snap action ^[5]		170 oz-in (1.2 N·m)	L100WNS2M26
		170 oz-in (1.2 N·m)	L300WNS2M26
Neutral position N.O.-CW, N.O.-CCW Maintained in CW only ^[5]		170 oz-in (1.2 N·m)	L100WNSL2M29
2 Step Sequence CW Spring return, Snap action, 2 N.O.		150 oz-in (1.06 N·m)	L525WDR2M56
2 Step Sequence CCW Spring return, Snap action, 2 N.O.		150 oz-in (1.06 N·m)	L525WDL2M57
2 Step Sequence CW Spring return, Snap action, 2 N.C.		150 oz-in (1.06 N·m)	L525WDL2M58
2 Step Sequence CCW Spring return, Snap action, 2 N.C.		150 oz-in (1.06 N·m)	L525WDR2M59
2 Step Sequence CW Spring return Snap action N.O./N.C		150 oz-in (1.06 N·m)	L100WS0S2M60

[5] The lever must not be allowed to snap freely from any overtravel position.

Interpreting the Catalog Numbers

Use the table below to interpret the catalog numbers of the L100/L300 switches. Do not generate new catalog numbers from the table. If the required contact sequence is not listed, contact your local field office.

The only modifications to the existing catalog numbers are:

- Mounting Plates—Style 1, 2, 3 or 4
- Front Covers—Metal, transparent plastic, or transparent plastic with a neon light.
- Special Features—Select from catalog **9006CT1007** and add to the type number.

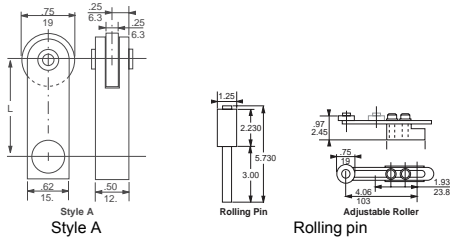

Style	Housing	Function	Mounting Plate	Front Cover	Contact Arrangement
L	1	0	0	W	S
			2	P	F
Standard (mill)	100		1		See catalog 9006CT1007
Extra heavy duty (foundry)	300		2		
	Two circuit single operation	WS	3	M	Standard metal
	Two circuit dual operation	WD	4	PF	Transparent plastic
	Triple circuit	WT		GF	Transparent plastic with neon light
	Neutral	WN			

Table 21.86: Steel Roller Lever Arms (0.25 in. wide, 0.75 in. dia.)

Length (L)		Lever Number
in.	mm	
1.50	(38.1)	AA
2.00	(50.8)	AH
2.50	(63.5)	AO
2.75	(69.8)	AK
3.00	(76.2)	AB
4.00	(101.6)	AM
6.00	(152.4)	AR

Table 21.87: Lever Arm Options [6]

Description	Suffix
1 in. diameter roller	1
1-1/4 in. diameter roller	4
1-1/2 in. diameter roller	2
Nylon roller	N
Ball bearing roller (3/4 in. diameter)	R
Stainless steel roller pin nylon roller	NS
Ex: AB1; ABR	

Table 21.88: Rolling Pin

For use with 2 step switches for conveyor or belt applications		
Length (L), In. (mm)		Lever Number
2.25 (75.1)		AL1650
2.25 (75.1)	(Teflon for high temperature applications)	AL16501
3 (50.8)		AL1802

Table 21.89: Roller, Adjustable

from 2 to 4 in. (0.25 in. wide, 0.75 in. diameter)		
Length (L), In. (mm)		Lever Number
Adjustable 2 to 4 (50.8 to 101.6)		AL2820

Table 21.90: Housing options [6]

Description	Examples	Prefix Adder or Modifier
3/4" conduit opening. Available on 2 circuit switches. Standard on 3 circuit switches.	L100WS2M1 changes to GL100WS2M1	G
High temperature 0 to +350 °F [7] Metal front cover only	L100WS2M1 changes to HL100WS2M1	H
Low temperature -20 to +200 °F [7]	L100WS2M1 changes to TL100WS2M1	T
High shock. Available only on operating sequences 1, 2, 4, 5, 7-11, 13, 14.	L100WS2M1 changes to L526WS2M1 L300WS2M1 changes to L326WS2M1	526/326
Gold contacts	L100WS2M1 changes to L522WS2M1 L300WS2M1 changes to L322WS2M1	522/322

Table 21.91: Wiring [6]

Description	Examples	Prefix Adder or Modifier
Straight male receptacle 4 pin [8]	Factory prewired L100WS2M1 changes to PL100WS2M1	P
90° Angle male receptacle 4 pin [8]	Factory prewired—facing right L100WS2M1 changes to APL100WS2M1	AP
Ministyle male receptacle [9]	8 A max., 5 pin (double circuit) 7 A max., 7 pin (triple circuit) L100WS2M1 changes to BL100WS2M1	B B
Potted and prewired	5 wires, 6 ft long 5 wires, 12 ft long 5 wires 18 ft long L100WS2M1 changes to L100WS2M1P L100WS2M1 changes to L100WS2M1P12 L100WS2M1 changes to L100WS2M1P18	P P12 P18

Table 21.92: Accessories

Description	Catalog Number
Sealed female plug and cable for P and AP receptacles	
4 pins, 16 AWG STO cable, 60 °C	4 ft 1010004 6 ft 1010006 10 ft 1010010
Sealed female plug and cable for ministyle receptacle (B)	
5 pins, 16 AWG STO cable, 105 °C	3 ft cable BH2053 6 ft cable BH2056 12 ft cable BH20512

Table 21.93: Front covers [6]

Description	Designator
Standard metal	M
Transparent plastic cover with metal frame	PF
Transparent plastic cover with metal frame and Neon indicator light (not connected)	GF

Example: L100WS2M1 changes to L100WS2PF1

[6] Some product configurations are not available—contact your Schneider Electric representative for details.
 [7] The minimum temperatures listed are based on the absence of freezing moisture or water.
 [8] Receptacle is a 4 pin male APL/PL-SWTS, Cannon part # MS3102E20-4P-F79 or equal.
 [9] Ministyle male receptacles are: 5-pin, Brad Harrison #41310 (or equal); 7-pin, Brad Harrison #42805 (or equal)