

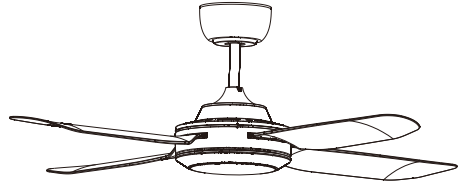

THE AIR MOVEMENT SPECIALISTS

SPINIKA II

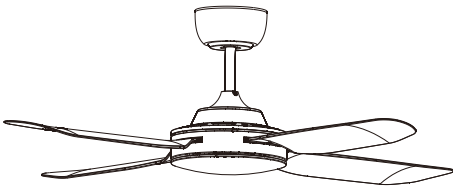

(This photo is for reference only; it does not mean you are purchasing an identical product. Fan picture is for illustration purposes only. Styles may vary according to the model.)

Ceiling Fan Installation Manual, Rev 1.0

SPINIKA II SERIES

Models:

SPIN1204BL

SPIN1204WH

SPIN1204TI

SPIN1304WH

SPIN1304BL

SPIN1304TI

SPIN1204WH-L

SPIN1204BL-L

SPIN1204TI-L

SPIN1304WH-L

SPIN1304BL-L

SPIN1304TI-L

CAUTION

Read Instructions Carefully
For Safe Installation and
Fan Operation

- INSTALLATION
- OPERATION
- MAINTENANCE
- WARRANTY INFORMATION



**MUST BE
INSTALLED
BY A LICENSED
ELECTRICIAN**

THANK YOU FOR PURCHASING

Thank you for purchasing this quality Ventair ceiling fan. To ensure correct function and safety, please read all instructions before using the product and keep all instructions for future reference.

SAFETY PRECAUTIONS

The information contained in the following pages has been prepared to ensure you of trouble-free operation of your ceiling fan.

1. To ensure the success of the installation, be sure to read the instruction and study the diagrams thoroughly.
2. All electrical work should only commence after disconnection of the power. Remove fuses or turn off the circuit breaker to ensure all pole isolation of the electrical supply.
3. Make sure that your installation site will not allow the rotating fan blades to come into contact with any object and that there is a minimum clearance of 150mm from the blade tip to the wall or ceiling. Please note that the greater the clearance around the fan, the better the airflow will be.
4. The fixing point for the fan must be able to support the weight of 4 times that of the net weight of the fan.
5. Do not connect the fan motor to a dimmer switch. This may give an unsatisfactory performance (motor hum) and cause damage to the motor.
6. It is not recommended that ceiling fans and gas appliances be operated in the same room at the same time.
7. The fan must be turned off and stopped completely before reversing the fan direction. This will prevent any damage to the motor of the unit or controller (if installed).
8. Do not insert anything into the fan blades while the fan is operating. This will damage the blades and upset the balance of the unit causing the unit to wobble.
9. After the fan is completely installed make sure that all connections are secured and tightened to prevent any problems.
10. Because of the fan's natural movement, some connections may loosen. Check the support connections, brackets and blade attachments twice a year to make sure they are all secured. If they are loose, tighten with a screwdriver.
11. Always have your fan installed by a licensed electrician.
12. This appliance is not intended for use by persons (including children) with reduced physical, sensory or mental capabilities, or lack of experience and knowledge, unless they have been given supervision or instruction concerning use of the appliance by a person responsible for their safety.
13. Children should be supervised to ensure that they do not play with the appliance.
14. That the fan is to be installed so that blades are 2.1m or more above the floor.

IMPORTANT:

This fan is suitable for indoor/ fully covered outdoor use only.

An all-pole disconnection switch must be incorporated into the fixed wiring, in accordance with local wiring rules.

SPECIFICATION

MODEL	Light Wattage (W)	Fan Wattage (W)	Voltage (V)	Frequency (Hz)	Net Weight (Kg)
SPIN1204WH SPIN1204BL SPIN1204TI	No Light	60 watts	220-240 V	50 Hz	6.80 kg
SPIN1204WH-L SPIN1204BL-L SPIN1204TI-L	20 watts	60 watts	220-240 V	50 Hz	7.00 kg
SPIN1304WH SPIN1304BL SPIN1304TI	No Light	65 watts	220-240 V	50 Hz	6.90 kg
SPIN1304WH-L SPIN1304BL-L SPIN1304TI-L	20 watts	65 watts	220-240 V	50 Hz	7.20 kg



The product is use for tropical climate areas.
tropical climate

INSTALLATION

IMPORTANT:

- 1.The fixing point on the ceiling, requires a solid bracing structure such as Timber noggins or joists.
- 2.The bracing should be butted up firmly and securely to the back of any non structural roofing panel such as plaster or Gyprock to ensure safety and optimum performance of the fan.
- 3.Please use fixing screws provided. These screws are rated to hold the fan securely and use of non appropriate screws such as Bugle Head shaped screws may void the warranty.
- 4.Poor fixing can create noise /excessive vibration and movement that is not covered by manufacturers warranty.

Mounting Plate Hanging System

1. Ceiling Joist (Please use the fixing screws provided. Use of non certified fixing screws may void the warranty.)
2. Canopy
3. Terminal Block and Mounting Plate
4. Earth Wire
5. Hanger Ball
6. Down rod
7. Safety steel wire (to be fixed on the bracket via the screw)

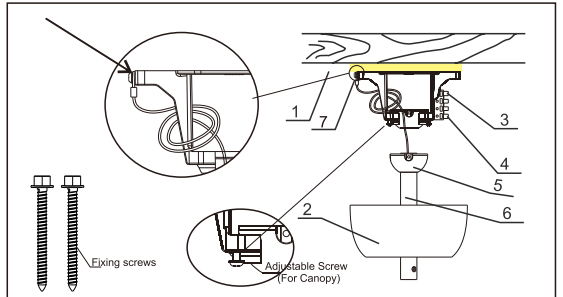

Please ensure the fixing tab fits into the groove of the hanger ball.

(Minor design changes may result in slight variations between the product illustrated and that which is contained in this package.)



INSTALLATION ON A RAKED CEILING

- 1.Please ensure the fixing tab fits in the groove of the hanger ball.
- 2.Ensure the fixing tab is set at the highest point.

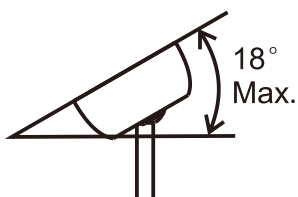

INSTALLING THE BLADES

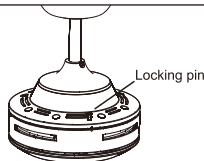

Locking pin

Ensure Locking pin is in Place. Motor will be fixed and line up with Blade holder holes.

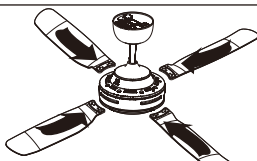

Slide blades fully into position. Holes will automatically align.

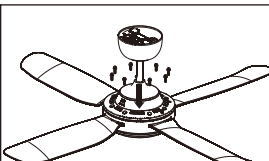

Drop all screws x 8 into screw locator holes. Apply gentle pressure, screws will self locate. Tighten to medium Firm.

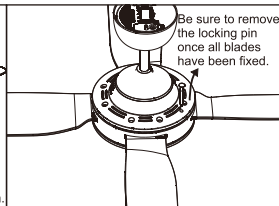

Be sure to remove the locking pin once all blades have been fixed.

FIXING THE UPPER CANOPY

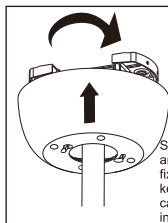

Slide canopy upwards and position ensuring fixing screws locate into keyhole shaped holes on canopy. Twist to secure into place.

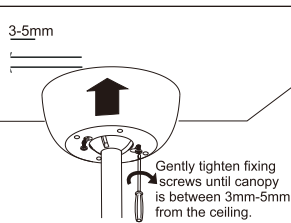

3-5mm

Gently tighten fixing screws until canopy is between 3mm-5mm from the ceiling.

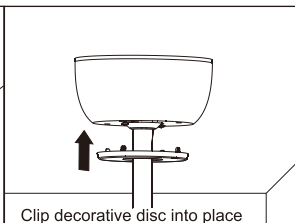

Clip decorative disc into place

CHANGING THE LED LIGHT TEMPERATURE

The LED on the fan with light models have a distinctive switch to change between three colour temperatures— Warm, Natural and Cool.

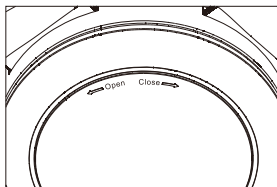

Twist the diffuser anti clockwise to remove, you will see the tri colour switch button on the LED panel. Press the button once, the light colour will change, press again and the light color will change again. It's circulation changes from Cool White, Natural and Warm White.

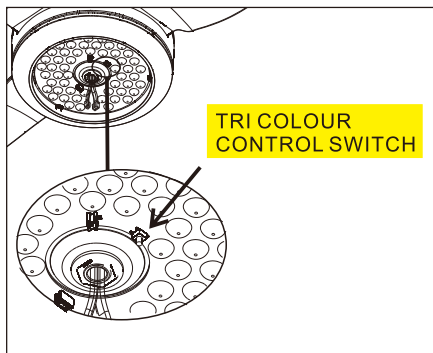

TRI COLOUR CONTROL SWITCH

USING A STANDARD WALL CONTROL

1. Turn control knob for fan speeds Eco/Med/High
2. Flick switch to 'On' Light will be 100%
3. While 'On' flick switch 'Off' then 'On' again within 2 seconds, the light will drop down to be at 75%. Continue the same process to reach 50% and 25% light level

NOTE: If light switch is 'Off' for more than 2seconds, the light will revert to 100% light setting when next operated.

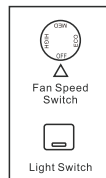

ON
Eco
Med
High
OFF

Fan Speed Control Switch

Light Switch

WITH REMOTE CONTROL

Model:SPNRF R

1. Use Eco/Med/High buttons to alter the fan speed.
2. "OFF" button will turn the fan off only
3. Turn Light"ON/OFF" for light.
4. Press the "STEP DIM" button to transition through 75%, 50%, 25% then back to 100% of light output.

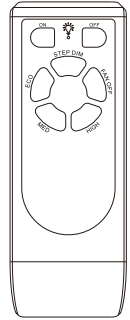

The remote handpiece comes factory paired with the remote receiver, but if you wish to pair a remote handpiece to multiple fans, see below

Step 1: Turn "OFF" isolation switch.

Step 2: Turn "ON" isolation switch and within 10 seconds, press LIGHT "ON" button for 3-4 seconds until a "Tick-Tack" sound is heard. (Repeat steps above if not successful).

WIRING DIAGRAM FOR WALL CONTROLLER

WARNING: FOR YOUR SAFETY,ENSURE THE MAINS SUPPLY IS SWITCHED OFF TO THE WIRING CIRCUIT BEFORE PERFORMING ANY ELECTRICAL TASKS.

PLEASE ENSURE YOU CHOOSE THE CORRECT WIRING DIAGRAM IN ACCORDANCE TO YOUR APPLICATION.

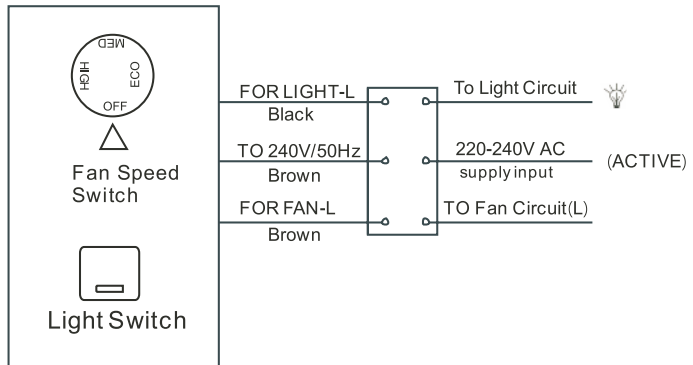

WIRING DIAGRAM FOR MOUNTING BRACKET TERMINAL & WALL CONTROL

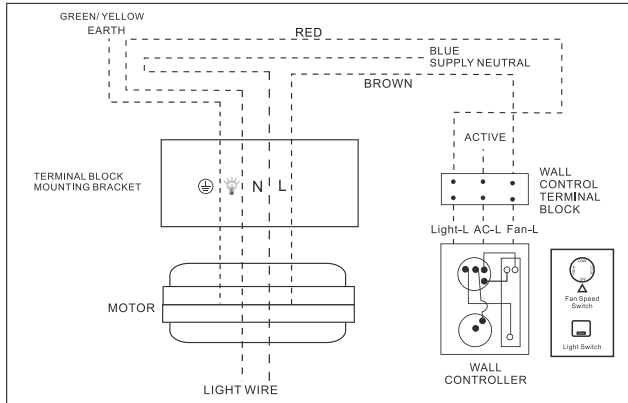

All pole disconnection switch must be included in the fixed wiring.

- Step 1. Connect EARTH wire to the terminal port marked "⊕" on the terminal block mounting bracket.
- Step 2. Connect the supply LIVE wire to the wall controller terminal port labeled "TO 240V/50Hz".
- Step 3. Connect a wire from the Fan Live "L" from the terminal block mounting bracket, to the terminal port labeled "FOR FAN-L" on the wall controller.
- Step 4. Connect a wire from the Light Live "💡" from the terminal mounting bracket, to the terminal port labeled "FOR LIGHT-L" on the wall controller. **Note: The fan light wiring is only applicable to fan models with a light kit.**
- Step 5. Connect the supply Neutral wire to the terminal port marked "N" on the terminal block mounting bracket.

Once all the above steps have been followed, you are now ready to restore the mains power supply. Make sure there is nobody near or under the fan, then turn on (and light switch if included in your model) to test.

WIRING DIAGRAM FOR ISOLATION SWITCH WITH REMOTE CONTROL

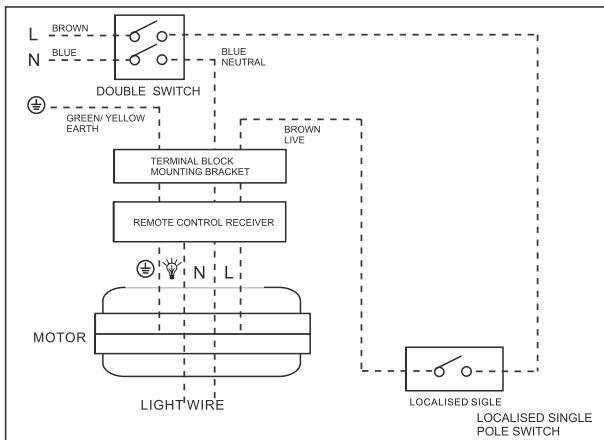

All pole disconnection switch must be included in the fixed wiring.

- Step 1:** Connect the EARTH wire to the terminal port marked "⊕" on the terminal block mounting bracket.
- Step 2 :** Connect the supply LIVE wire to Localised single pole switch and then wire to terminal port marked "L" on the terminal block mounting bracket.
- Step 3:** Connect the supply Neutral wire to the terminal port marked "N" on the terminal block mounting bracket

REPLACING THE LED PANEL

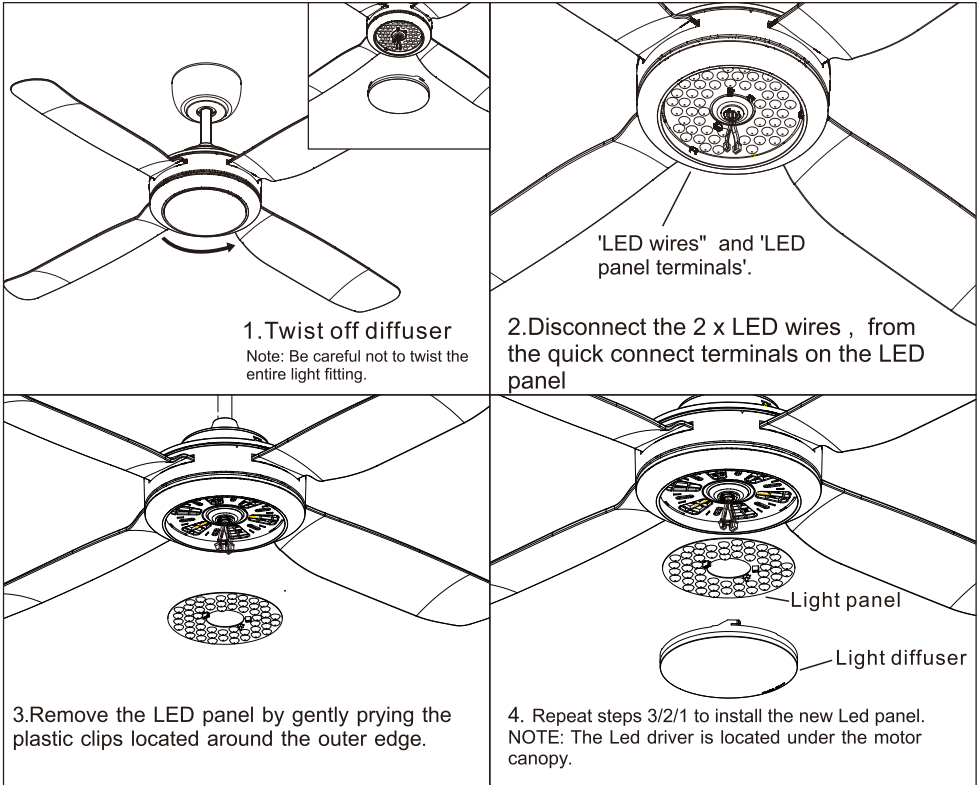

ATTACHING REMOTE RECEIVER

SPNFRF Available as optional Extra

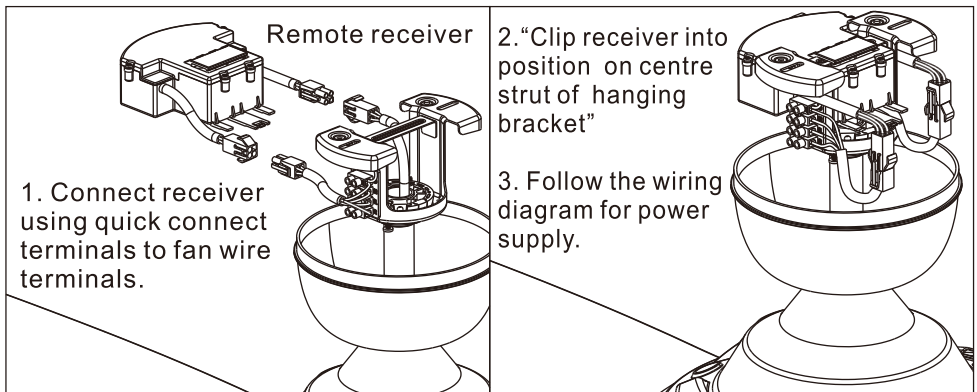

WARNING: FOR YOUR SAFETY, ENSURE THE MAINS SUPPLY IS SWITCHED OFF TO THE WIRING CIRCUIT BEFORE PERFORMING ANY ELECTRICAL TASKS.

INSTALLATION TIPS

Only use the included wall control plate- using other wall control plate will void warranty and may damage the fan.

Do not use a solid-state dimmer control.

Do not use the light switch(if included) to control the fan motor ;

The wall control shall fit into existing gang block or wall plate. If you do not flush mount the control use a standard single gang mounting block.

Be careful not to mix the supply live and the fan live connection.Reverse connection of the speed control will affect the correct operation of the fan

After the wiring connections are completed, ensure that all wires are arranged in a tidy manner and make sure the ball sits well into the bracket, this is important to ensure optimal performance.

OPERATION

To turn the fan on, simply turn the switch knob to the (ECO,MED,HIGH) position.

To turn the fan off, turn the switch knob the (OFF) position.

TROUBLESHOOTING

Check and inspect the motor,the down rod and other components for shaking, abnormal sound and vibration when operating.

Please check position of the blade .

- Change position of the blade .
- Check and make even height of three blades.
- (The difference of blades to be within 5mm)
- Check looseness of screws, bolts and nuts.

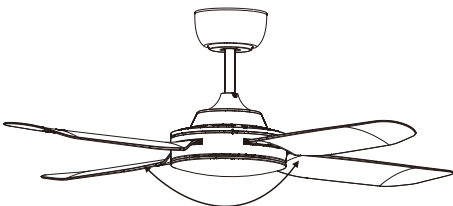

Change blade

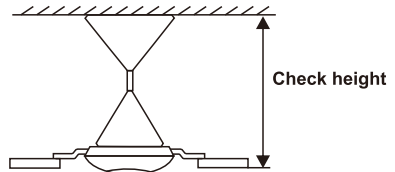

MAINTENANCE

- Use this in a dry place, free of excessive humidity and water.
- Keep the fan clean. Wipe away dirt with a clean soft cloth, ordinary soap and water, wipe dry. Do not use solvents, etc. (gasoline or petroleum.)
- Make sure to disconnect the power supply before cleaning and maintenance is carried out.
- Ensure that the fan is switched off from the supply mains before removing the guard.

The points described below should be checked, and corrected if necessary once each year:

Do the motor, piping or other components shake or vibrate abnormally?

Shaking and abnormal vibration can be caused if the blade holding screw or screws for the suspended part are loose, or if a blade is deformed, if a blade is deformed, all 3 blades should be replaced as a set.

Is there any unusual noise?

Are the blade holding screw or screw for the suspended part loose? Is the canopy in contact with ceiling surface?

WARNING:

If at any stage the fan develops excessive wobbling, contact the manufacturer its service agent or suitably qualified persons.

NIGHT NOISE

This is the biggest cause for service calls, which are outside the manufacturer's warranty. If a fan has a fault, it will be noticeable at all times. Naturally when everything is quiet at night, you will be more inclined to hear small noises, which may not be noticeable at other times. Even slight power fluctuations and/or mains frequency control signals superimposed in your electricity supply for off-peak hot water control may cause a change in fan motor noise. This is normal.



Do not dispose of electrical products with household waste. Please check with your local council for advice on disposal or recycling. If electrical appliances are disposed of in landfills or dumps, hazardous substances can leak into the groundwater and get into the food chain, damaging your health and well-being.

ventairtm
THE AIR MOVEMENT SPECIALISTS

4 CAPITAL PLACE
CARRUM DOWNS VIC 3201
PHONE: (03) 9775 0556
FAX: (03) 9775 0775